

Productcatalogus

2023/2024

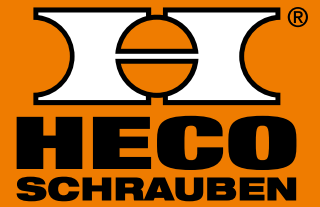



Geachte klant,

Als schroevenfabrikant en -leverancier werken wij aan de ontwikkeling van innovatieve bevestigingstechnologieën voor professionele gebruikers. Met deze productcatalogus illustreren wij deze innovatiekracht op indrukwekkende wijze.

De nieuwe, innovatieve universeelschroef HECO-TOPIX-plus is de opvolger van onze beproefde schroevenfamilies HECO-FIX-plus, HECO-TOPIX, HECO-UNIX-plus en HECO-UNIX-top. De HECO-productcatalogus is dus dunner en overzichtelijker geworden. Wij zijn er trots op dat alle toepassingen die u tot nu toe via het HECO-assortiment hebt afgedekt, ook in de toekomst met ons aanbod kunnen worden gerealiseerd. Of u nu in de vakhandel of als vakman werkzaam bent: u zult niet alleen de technische voordelen van de nieuwe HECO-TOPIX-plus, maar ook de overzichtelijkheid van het nieuwe assortiment waarderen.

Tijdens het doorlezen van de nieuwe productcatalogus zult u merken dat wij de innovatieve USP's van HECO-TOPIX-plus: „GripFit“, „MagicClose“ en „PerfectPitch“ via pictogrammen in het assortiment aanduiden. U ziet dus meteen welke producteigenschappen de betreffende schroef biedt. Daarnaast hebben wij een kleurcodesysteem voor de aandrijfgrootten toegevoegd dat op de verpakking van de schroeven terug te vinden is. Trouwens: ook het ontwerp van de verpakkingen werd herzien en gemoderniseerd. Hiermee verhogen wij de herkenbaarheid van het merk HECO op de POS, op de bouwplaats of in de stellingen bij de dealers. De etiketten op de verpakking zijn nu in kleur gedrukt en duidelijk overzichtelijker. Via een voor elk artikel individuele QR-code kan de geïnteresseerde alle relevante productinformatie, begeleidende documenten zoals goedkeuringen of prestatieverklaringen via internet opvragen.

Een handige uitbreiding zijn bijvoorbeeld de QR-codes die u op veel pagina's van deze catalogus zult tegenkomen. U kunt deze met een QR-code-lezer op uw smartphone of tablet scannen om vervolgens te worden doorgelinkt naar ons YouTube-kanaal waar in duidelijke video's praktische montagetips voor het betreffende product worden gegeven. Naast de QR-code geeft ook het bekende YouTube-logo aan dat er voor het betreffende product een video beschikbaar is. Het HECO-kanaal omvat al tientallen clips en wordt geleidelijk uitgebreid met meer animaties.

Naast de gedrukte versie, raden wij u ook de interactieve PDF-versie van onze nieuwe productcatalogus aan. Deze kunt u in het Download-gedeelte op onze website downloaden. In het PDF-document gaat u ook hier door scannen resp. aanklikken van de QR-code rechtstreeks naar ons YouTube-kanaal en door een klik op de afzonderlijke artikelnummers naar een uitgebreide beschrijving van het gewenste product op www.heco-schrauben.com.

Deze technische uitbreidingen maken van deze productcatalogus een interactief naslagwerk dat de keuze voor het juiste product nog verder vergemakkelijkt. Wij wensen u veel succes met onze hoogwaardige kwaliteitsschroeven en zien een verdere goede samenwerking met u tegemoet.

Met vriendelijke groeten uit het Zwarte Woud,
Uw HECO-team

HECO door de jaren heen

Het succesverhaal van de firma HECO begint in de privévertrekken van de knutselaar Karl Hettich uit het Duitse Schramberg. Hij vindt een buigautomaat uit voor de vervaardiging van echappementen die nodig zijn in de uurwerkindustrie van Schramberg. Na de vroege dood van hun vader breiden de zonen van Karl Hettich de florierende zaak uit.

In 1936 begint de firma Hettich ook met de productie van schroeven. Ludwig Hettich, een kleinzoon van de oprichter van de firma, licht in 1967 de schroefproductie uit de Franz Hettich KG en richt de firma Ludwig Hettich & Co. Schraubenfabrik; dit is het allereerste begin van HECO!

Als Ludwig Hettich in 1975 sterft, neemt met de oudste zoon Stefan Hettich de vierde generatie de bedrijfsleiding op zich. Stefan Hettich zet in op de consequente ontwikkeling van het merk HECO en optimaliseert de productieprocessen en de logistiek. Sinds 2006 versterkt zijn broer Guido Hettich het HECO-team als tweede directielid van de onderneming.

Heden ontwikkelen, produceren en verkopen meer dan 400 medewerkers innovatieve schroeven en bevestigingselementen, die wereldwijd met succes ingezet worden en bekend staan om hun hoge kwaliteit en veiligheid.



Het hoofdkantoor en fabriek in Schramberg-Sulgen



Fabriek in Campia Turzii, Roemenië



Logistiek Centrum in Schramberg-Sulgen

1888

Karl Hettich vindt een buigapparaat uit voor echappementen en legt de basis voor een lange bedrijfstraditie



De start: de ankerhaken, geproduceerd op een door Karl Hettich ontwikkeld buigautomaat

1936

Het Hettich familiebedrijf begint met de productie van schroeven

1967

Ludwig Hettich licht de schroevenproductie uit de Franz Hettich KG en richt de Ludwig Hettich & Co. Schraubenfabrik op

1971

Het bedrijf betreft het nieuw gebouwde productie- en administratiegebouw in Schramberg-Sulgen

1975

Na de dood van de oprichter van het bedrijf neemt met Stefan Hettich de volgende generatie de bedrijfsleiding van de firma HECO op zich

1978

Het bedrijf presenteert de spaanplaatschroef **HECO-FIX®**. Met deze schroef is ook het merk HECO geboren



Karl Hettich – Oprichter van de Hettich familieonderneming



Rond 1895 – eerste vestiging van het Hettich-familiebedrijf



Ludwig Hettich – Oprichter van de huidige onderneming HECO-Schrauben GmbH & Co. KG



1967 – eerste vestiging van HECO-Schrauben GmbH & Co. KG

1989

HECO richt een eigen gereedschapsmakerij als basis voor de ontwikkeling en productie van innovatieve schroeven

2000

Presentatie van de houtschroef **HECO-TOPIX®**

2010

Presentatie van de **HECO-UNIX-schroef**

2016

Presentatie van de nieuwe **MULTI-MONTI®-plus** schroefankers

1990

Presentatie van de eerste eigen ontwikkelde universeel schroef **HECO-FIX-plus®**

2004

Oprichting van HECO France sarl als verkooporganisatie in Frankrijk

2014

Inwijding van het nieuwe Logistiek Centrum in Schramberg-Sulgen

2018

Presentatie van het nieuwe **speciale houtbouw assortiment**

1995

Presentatie van het schroefanker **MULTI-MONTI®**, waarvoor HECO later de innovatieprijs van de deelstaat Baden-Württemberg ontvangt

2009

Oprichting van de productie-onderneming S.C. HECO SCHRAUBEN S.R.L. in Roemenië

2015

Introductie van de nieuw ontwikkelde **HECO-UFIX® MDF-schroef** en begin van samenwerking met **SFS Group AG**

2020-2021

Vervanging van de huidige schroeflijnen door het nieuwe universele schroef assortiment **HECO-TOPIX®-plus**

Bewezen kwaliteit!

HECO-schroeven zijn wereldwijd het toppunt van veiligheid en betrouwbaarheid in de bevestigingstechniek. Om telkens te voldoen aan de eigen kwaliteitseisen, onderwerpen wij onze nieuwe ontwikkelingen aan uitgebreide testen, voordat wij ze op de markt brengen. Daarbij let HECO bij alle producten op een gelijkblijvend hoge kwaliteits- en veiligheidsstandaard en laat deze ook regelmatig certificeren door externe keuringsinstanties.

Een belangrijke grootheid in het kader van het goedkeuringsproces van schroeven is de „Europese Technische Goedkeuring“ (ETA) als algemeen erkend bewijs voor de technische prestatiebestendigheid van een bouwproduct.

De door technische beoordelingsinstantie (DIBt) afgegeven ETA-documenten maken voor ons als fabrikant de CE-markering van onze bevestigingsproducten en zo de ongehinderde toegang tot de Europese markt mogelijk. Samen met de algemeen bouwkundige goedkeuringen documenteren zij onze innovatiekracht en signaleren de klant dat hij op elk moment kan vertrouwen op de betrouwbaarheid en veiligheid van de HECO-producten.

Hierna stellen wij alle belangrijke logos aan u voor die in deze catalogus voor de afzonderlijke productgroepen van belang zijn. Zo krijgt u snel een overzicht van de goedkeuringen die onze schroeven hebben en vindt u snel het juiste product.



Europese Technische Goedkeuring (ETA)

Bij de verkoop van bevestigingsmiddelen in heel Europa moet in veel gevallen een CE-markering worden getoond. Basis van de noodzakelijke CE-overeenstemming is een Europese Technische Goedkeuring (ETA) die alle technische eigenschappen van een bouwproduct behandelt. De daarbij behorende prestatieverklaringen (DoP –Declaration of Performance) zijn beschikbaar voor alle producten.



Algemeen Bouwkundige Goedkeuring en Ü-symbool

Met de rode cirkel zijn producten en productgroepen gemarkeerd waarvoor het „Deutsches Institut für Bautechnik“ (DIBt) een nationale (toepassings) Goedkeuring verleend heeft. Een eventueel extra aangebracht Ü-symbool documenteert de overeenstemming met de in de Goedkeuring gedefinieerde eisen en de bij het DIBt vastgelegde technische productspecificaties. Het vermeldt ook de externe bewakingsinstantie die de nalevering van de specificaties controleert.



SKH-certificering

Het SKH-keurmerk is een keuringscertificaat dat op de Nederlandse markt wordt aangetroffen. De Stichting Keuringsbureau Hout (SKH) beoogt met het toekennen ervan verbetering van de kwaliteitsborging in die bouwsectoren waar hout en houtproducten worden gebruikt. Producten met SKH-keurmerk signaleren dat de fabrikant zich heeft onderworpen aan het Nederlandse keuringsstelsel en heeft voldaan aan de daar geldende eisen.



Sprinkler-Logo

De met het sprinkler-logo gemarkeerde MULTI-MONTI schroefankers voldoen aan de eisen van de Vds-richtlijn CEA 4001, die een standaard voor de planning en inbouw van sprinklerinstallaties vastlegt.

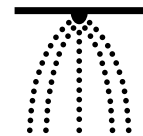

Brandwerendheidsklasse

Bouwproducten als de MULTI-MONTI schroefankers worden overeenkomstig hun brandwerendheidsduur ingedeeld in verschillende brandwerendheidsklassen. De rode vlamsymbolen en de toevoeging „R120“ geven aan dat deze producten zeer brandbestendig en daardoor in staat zijn het draagvermogen van een gemonteerd onderdeel (bijv. een sprinklerinstallatie) bij een brand gedurende 120 minuten te behouden.



Seismische beoordeling

Met het seismiek-symbool wordt de betrouwbaarheid van onze MULTI-MONTI-plus schroefankers bij een seismische inwerking weergegeven. Producten van prestatieklasse „C1“ zijn geschikt voor niet dragende elementen en „C2“ zijn geschikt voor dragende elementen onder aardbevingsbelasting conform de adviezen TR 045 van de Europese Organisatie voor Technische Goedkeuringen (EOTA). De seismiek-goedkeuring maakt deel uit van de ETA-goedkeuring.



Meer informatie

Alle goedkeuringsbewijzen en prestatieverklaringen van onze gecertificeerde HECO-producten kunnen ook online worden opgevraagd: www.heco-schrauben.nl

Meer informatie over de producten vindt u op:

www.youtube.com/HECO-Schrauben

of direct bij HECO op:

E-Mail: office@lowie.nl

Telefoon Jac. Lowie & Zoon bv: +31 (0) 35 - 541 59 58

Telefoon toepassingstechniek bij Lowie: +31 (0) 35 - 541 59 58

Toepassingstechniek bij HECO: +49 (0) 74 22 / 9 89-205 of -212



HECO-verpakkingen

Product informatie

VARIANTA verpakkingen

- Opening aan de voorkant als schuiver
- Opening boven in verpakking via perforatie
- Etiket aan de voorkant met plakstrip, (beveiliging)

O-verpakking

- Stabiele kwalitatief hoogwaardige verpakking
- Uniforme breedte en hoogte
- Logisch verpakkingssysteem: tot en met schroeflengte 500 mm in omverpakking geleverd

SKV-kleinverpakking

- Opening in principe aan de zijkant links met vingergat
- Etiket aan de voorkant met plakstrip, (beveiliging)
- EAN-code boven (bij SKV 5 aan de voorkant)

Kunststof dozen

- Weerbestendig
- Afsluitbaar met een deksel
- Herbruikbaar
- Optimale handling op bouwplaatsen

Gewoon goed verpakt

Voor handel, handwerk, industrie of doe-het-zelvers – HECO® biedt u een uniform en uitgebreid assortiment aan kleine, industrie- en DIY-verpakkingen.

Goed verpakt in de geoptimaliseerde omverpakkingen

Voor de HECO-verpakkingen is er een consistent omdoosconcept: de afmetingen van de omdozen zijn afgestemd op de standaardmaat van de Europallet. De breedte is altijd 20 cm, en de lengte van de doos is variabel met 30, 40 of 60 cm, evenals de hoogte van de doos. Elk artikel is toegewezen aan een passende omdoos, wat het aantal verpakkingseenheden per omdoos en de hoeveelheid schroeven per omdoos of per pallet bepaalt.

Beschermd bij weer en wind

Dankzij de lakcoating van alle verpakkingen zijn deze extreem vochtbestendig en uitermate geschikt voor gebruik op de bouwplaats.

Verpakkingsvarianten:

- **VARIANTA verpakkingen**
 - VARIANTA verpakking
 - O-verpakking
- **SKV-kleinverpakking**
- **Kunststof dozen**



Goed verpakt dankzij het uniforme omverpakkingconcept.



Extreem vochtbestendig dankzij lakcoating.

VARIANTA verpakking

| Verpakkingsnummer | Verpakking | | | Omverpakking | | | | |
|-------------------|-------------|--------------|-------------|--------------------|-------------|--------------|-------------|-------------------------------|
| | Lengte [mm] | Breedte [mm] | Hoogte [mm] | Omverpakingsnummer | Lengte [mm] | Breedte [mm] | Hoogte [mm] | Verpakkingen per omverpakking |
| VAR 1 | 85 | 90 | 75 | UK 3 | 400 | 200 | 105 | 10 |
| VAR 2 | 150 | 90 | 75 | UK 5 | 400 | 200 | 160 | 10 |
| VAR 3 | 185 | 90 | 75 | UK 3/UK 6 | 400 | 200 | 105/200 | 5/10 |
| VAR 4 | 230 | 90 | 75 | UK 1 | 400 | 200 | 250 | 10 |

O-verpakking

| Verpakkingsnummer | Verpakking | | | Omverpakking | | | | |
|-------------------|-------------|--------------|-------------|--------------------|-------------|--------------|-------------|-------------------------------|
| | Lengte [mm] | Breedte [mm] | Hoogte [mm] | Omverpakingsnummer | Lengte [mm] | Breedte [mm] | Hoogte [mm] | Verpakkingen per omverpakking |
| O150 | 150 | 90 | 75 | UK 5 | 400 | 200 | 160 | 10 |
| O185 | 185 | 90 | 75 | UK 3/UK 6 | 400 | 200 | 105/200 | 5/10 |
| O190 | 190 | 90 | 92 | UK 3 | 400 | 200 | 105 | 4 |
| O290 | 290 | 90 | 92 | UK 7 | 300 | 200 | 200 | 4 |
| O390 | 390 | 90 | 92 | UK 3/UK 6 | 400 | 200 | 105/200 | 2/4 |
| O490 | 490 | 90 | 92 | UK 8 | 600 | 200 | 200 | 4 |
| O590 | 590 | 90 | 92 | UK 8 | 600 | 200 | 200 | 4 |
| O850 | 850 | 90 | 92 | - | - | - | - | - |
| O1150 | 1150 | 90 | 92 | - | - | - | - | - |

SKV-kleinverpakking

| Verpakkingsnummer | Verpakking | | | Omverpakking | | | | |
|-------------------|-------------|--------------|-------------|--------------------|-------------|--------------|-------------|-------------------------------|
| | Lengte [mm] | Breedte [mm] | Hoogte [mm] | Omverpakingsnummer | Lengte [mm] | Breedte [mm] | Hoogte [mm] | Verpakkingen per omverpakking |
| SKV 1 | 45 | 60 | 45 | UK 2 | 400 | 200 | 65 | 24 |
| SKV 2 | 60 | 60 | 45 | UK 2 | 400 | 200 | 65 | 24 |
| SKV 3 | 85 | 60 | 45 | UK 3 | 400 | 200 | 105 | 24 |
| SKV 4 | 75 | 90 | 60 | UK 4 | 400 | 200 | 135 | 20 |
| SKV 5 | 85 | 90 | 75 | UK 6 | 400 | 200 | 200 | 20 |

Kunststof dozen

| Verpakkingsnummer | Verpakking | | | Omverpakking | | | | |
|-------------------|-------------|--------------|-------------|--------------------|-------------|--------------|-------------|-------------------------------|
| | Lengte [mm] | Breedte [mm] | Hoogte [mm] | Omverpakingsnummer | Lengte [mm] | Breedte [mm] | Hoogte [mm] | Verpakkingen per omverpakking |
| H1 | 140 | 122 | 85 | UK 9 | 325 | 260 | 185 | 8 |
| H2 | 140 | 122 | 126 | UK 10 | 325 | 260 | 140 | 4 |
| H3 | 198 | 198 | 140 | UK 6 | 400 | 200 | 200 | 2 |

Nieuwe verpakkingsetiketten

Professionele gebruikers die bewust kiezen voor een kwalitatief hoogwaardig product, hechten zeer aan een correcte en begrijpelijke aanduiding op de verpakking. Dat zorgt voor veiligheid tijdens de aankoop, maar ook voor een eenvoudige en eenduidige identificatie tijdens de inzet op de bouwplaats. Om nog beter aan deze criteria te voldoen, werden de HECO-verpakkingsetiketten volledig herzien. Hierbij is speciale aandacht geschonken aan het evenwicht tussen de inhoudelijke volledigheid en een begrijpelijke structuur.

Productafbeeldingen in kleur

De grote productafbeeldingen in kleur zijn een van de grootste vernieuwingen op het etiket. Zij dienen als eerste aanwijzing voor de identificatie van de schroef. Kenmerken zoals kop, schroefdraad, aandrijving en oppervlak zijn zo direct herkenbaar.

Schroefafmeting

De afmeting van de schroef en de verpakkingmaat staan, als belangrijkste criteria bij de keuze van de variant, in een oranje-kleurige box en zijn zo duidelijk geaccentueerd.

Aandrijving/aandrijfmaat

Eveneens nieuw is de aanduiding van de aandrijving. HECO heeft voor het eerst een kleurcodesysteem voor de afzonderlijke aandrijf-/bitgrootte ingevoerd. Dit is ook op het etiket terug te vinden en vergemakkelijkt zo de toewijzing van de schroef aan de bijpassende HECO-bit.

QR-code voor aanvullende productinformatie

Professionele gebruikers hebben een grote behoefte aan gedetailleerde technische informatie die helaas niet volledig op een gedrukt etiket kan worden weergegeven. Daarom biedt HECO met de nieuwe etiketten de mogelijkheid om via het scannen van de QR-code met een smartphone uitgebreide informatie over het artikel op te vragen. Zo krijgen gebruikers eenvoudig toegang tot uitgebreide omschrijvingen, productvoordelen, technische details en downloads van documenten zoals goedkeuringen en prestatieverklaringen. Hierbij is de toegang zo software- en apparaatonafhankelijk als mogelijk ontworpen. Daarom kunnen de gegevens met elke smartphone en zonder de voorafgaande installatie van een speciale app worden opgevraagd. U hebt hiervoor alleen een internettoegang en een willekeurige QR-code-scanner nodig.

Overzicht over de inhoud van de etiketten

Productafbeelding
Snelle identificatie dankzij gedetailleerde, afbeelding in kleur

Artikelnummer
Eenduidig identificatienummer van het artikel

QR-code
Webweergave van gedetailleerde productinformatie

Goedkeuringen/certificaten
Gedeelte voor goedkeuringinformatie

Afmeting van de schroef
Diameter x lengte (mm)

Hoeveelheid
Aantal schroeven per verpakking

Productfamilie / -variant
Basisinformatie over het artikel
lg = schroefdraadlengte

Aandrijving
Type en maat, kleurtoewijzing aan bit

Oppervlakte/materiaal
Eenvoudige onderscheiding dankzij gekleurde achtergrond:
blauw = blauw verzinkt
geel = geel verzinkt
groen = rvs A2
rood = rvs A4
grijs = HP-coating

Label Content:
HECO-TOPIX-plus
Senkkopf, Teilgewinde
6,0 x 200 lg: 72
100
6,0 x 200
HD-30
ZINK blauw, A3K
MADE IN GERMANY
Produced by HECO
Batch:
4 019787 611800
Art.Nr. 61180
HECO-Werk 1
ETA-19/05583
Dach-19-05583-01
SKH
SKH-001
EAD 130118-01-0605

Structuur van de catalogus

Om de oriëntatie in de catalogus te vergemakkelijken, hebben wij de 6 productgroepen van een kleurcodering voorzien (zie het overzicht).











Voor een snelle oriëntatie worden naast de kleurcodering ook korte omschrijvingen van onze HECO-merkproducten en een CAD-weergave van de betreffende schroeven getoond.

Kleurselectie en bijbehorend assortiment

- HECO-TOPIX®-plus
- HECO-UFIX®
- Houtbouw speciaal

- MULTI-MONTI®-plus
- MULTI-MONTI®-plus Roestvaststaal
- HECO-accessoires

Kleurcodering voor aandrijf-/bitgrootten

-  T-10/HD-10
-  T-15/HD-15
-  T-20/HD-20
-  T-25/HD-25
-  T-30/HD-30
-  T-40/HD-40
-  T-45/HD-45
-  T-50/HD-50
-  PZD-1
-  PZD-2
-  PZD-3

Artikellabel HECO-TOPIX-plus

↓
Korte omschrijving

↓
Uitgebreide productomschrijving

↓
Toewijzing van de HECO-TOPIX-plus-eigenschappen

HTP HECO-TOPIX®-plus



Uitvoering: platverzinken kop met freeshotles

Aandrijving: HECO-Drive

Draadtype: variabele voldraad

Materiaal: koolstofstaal

Oppervlakte: verzinkt blauw, A3K CHROME (VI) FREE Kleurcode op het HECO-etiket

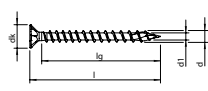

| Almeting d x l [mm] | Draadlengte lg [mm] | Kopdiameter dk [mm] | Aandrijving | ETA | Artikelnummer | Aantal per verpakking [st.] | Type verpakking | Aantal per omverpakking [st.] |
|---------------------|---------------------|---------------------|-------------|-------|---------------|-----------------------------|-----------------|-------------------------------|
| 5,0 | 20 | 14 | 9,6 | HD-20 | 60806 | 200 | SKV | 4.800 |
| 20 | 14 | 9,6 | HD-20 | 60807 | 500 | VARIANTA | 5.000 | |
| 25 | 19 | 9,6 | HD-20 | 60818 | 200 | SKV | 4.000 | |
| 25 | 19 | 9,6 | HD-20 | 60819 | 500 | VARIANTA | 5.000 | |
| 30 | 24 | 9,6 | HD-20 | 60832 | 200 | SKV | 4.000 | |
| 30 | 24 | 9,6 | HD-20 | 60833 | 500 | VARIANTA | 5.000 | |
| 35 | 29 | 9,6 | HD-20 | 60851 | 200 | SKV | 4.000 | |
| 35 | 29 | 9,6 | HD-20 | 60852 | 500 | VARIANTA | 5.000 | |
| 40 | 34 | 9,6 | HD-20 | 60869 | 200 | SKV | 4.000 | |
| 40 | 34 | 9,6 | HD-20 | 60870 | 500 | VARIANTA | 5.000 | |
| 45 | 39 | 9,6 | HD-20 | 60887 | 200 | VARIANTA | 2.000 | |
| 50 | 44 | 9,6 | HD-20 | 60900 | 200 | VARIANTA | 2.000 | |
| 55 | 49 | 9,6 | HD-20 | 60914 | 200 | VARIANTA | 2.000 | |

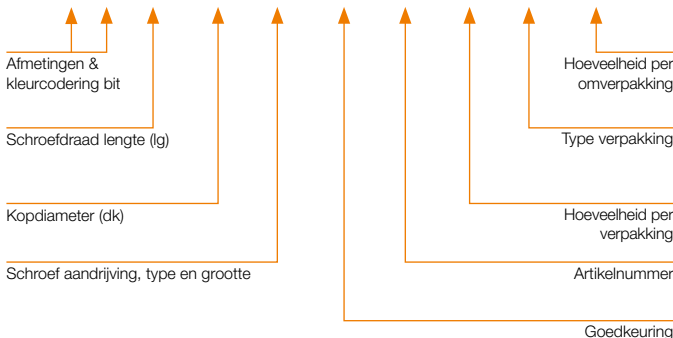

Artikellabel MULTI-MONTI-plus

↓
Korte omschrijving

↓
Uitgebreide productomschrijving

MMS-plus MULTI-MONTI®-plus



Uitvoering: MMS-plus SS, zeskantkop met aangepaste ring

Aandrijving: zeskantkop

Materiaal: koolstofstaal



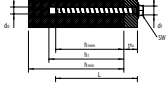



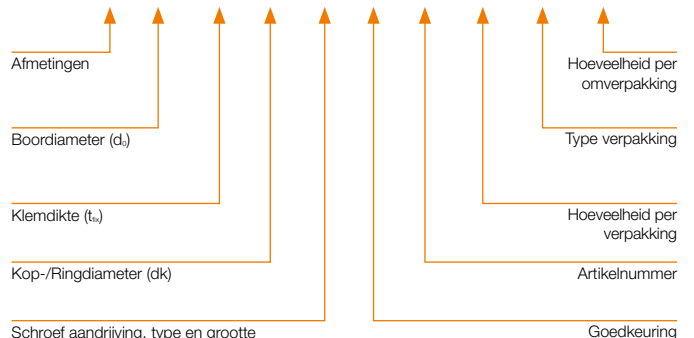













Oppervlakte: verzinkt blauw, A2K CHROME (VI) FREE Kleurcode op het HECO-etiket









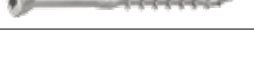





















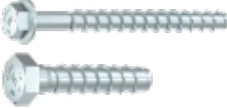

| Almeting d x l [mm] | Boordiameter d _i [mm] | Klemdikte t _w [mm] | Ringdiameter d _k [mm] | Aandrijving | ETA | Artikelnummer | Aantal per verpakking [st.] | Type verpakking | Aantal per omverpakking [st.] |
|---------------------|----------------------------------|-------------------------------|----------------------------------|-------------|-------|---------------|-----------------------------|-----------------|-------------------------------|
| 6,0 | 40 | 5,0 | 5/15 | 11,0 | SW-8 | 48381 | 100 | VARIANTA | 1.000 |
| 50 | 5,0 | 5/15(25) | 11,0 | SW-8 | 48383 | 100 | VARIANTA | 1.000 | |
| 60 | 5,0 | 15/25(35) | 11,0 | SW-8 | 48385 | 100 | VARIANTA | 1.000 | |
| 70 | 5,0 | 25/35(45) | 11,0 | SW-8 | 48387 | 100 | VARIANTA | 1.000 | |
| 80 | 5,0 | 35/45(55) | 11,0 | SW-8 | 49816 | 50 | VARIANTA | 500 | |
| 7,5 | 35 | 6,0 | 1/10 | 14,0 | SW-10 | 49846 | 100 | VARIANTA | 1.000 |
| 40 | 6,0 | 5/15 | 14,0 | SW-10 | 48389 | 100 | VARIANTA | 1.000 | |
| 50 | 6,0 | 15/25 | 14,0 | SW-10 | 48391 | 50 | VARIANTA | 500 | |
| 60 | 6,0 | 5/25(35) | 14,0 | SW-10 | 48393 | 50 | VARIANTA | 500 | |
| 70 | 6,0 | 15/35(45) | 14,0 | SW-10 | 48395 | 50 | VARIANTA | 500 | |
| 80 | 6,0 | 25/45(55) | 14,0 | SW-10 | 48397 | 50 | VARIANTA | 500 | |
| 100 | 6,0 | 45/65(75) | 14,0 | SW-10 | 49817 | 50 | VARIANTA | 500 | |
| 120 | 6,0 | 65/85(95) | 14,0 | SW-10 | 49819 | 50 | VARIANTA | 400 | |



| HECO-TOPIX®-plus | | | 18 |
|---|--------------|--------------------------|----|
| Platverzonken kop met freesholtes | | | 22 |
| HECO-Drive, voldraad | NIEUW | verzinkt blauw, A3K | 22 |
| | | verzinkt geel, A3L | 28 |
| | | roestvaststaal A2 1.4567 | 30 |
| HECO-Drive, deeldraad | NIEUW | verzinkt blauw, A3K | 32 |
| | | verzinkt geel, A3L | 36 |
| | | roestvaststaal A2 1.4567 | 38 |
| Pozi-Drive, voldraad | | verzinkt blauw, A3K | 40 |
| | | verzinkt geel, A3L | 45 |
| | | roestvaststaal A2 1.4567 | 47 |
| Pozi-Drive, deeldraad | | verzinkt blauw, A3K | 49 |
| | | verzinkt geel, A3L | 52 |
| Kleine platverzonken kop | | | 54 |
| Pozi-Drive, voldraad | | verzinkt blauw, A3K | 54 |
| Platverzonken kop met koggatboring 2,4mm | | | 55 |
| Pozi-Drive, voldraad | | verzinkt blauw, A3K | 55 |
| Rondkop | | | 56 |
| T-Drive, voldraad | NIEUW | verzinkt blauw, A3K | 56 |
| | | roestvaststaal A2 1.4567 | 58 |
| Pozi-Drive, voldraad | | verzinkt blauw, A3K | 59 |
| | | roestvaststaal A2 1.4567 | 64 |
| Verzonken lenskop met freesholtes | | | 66 |
| HECO-Drive, voldraad | | roestvaststaal A2 1.4567 | 66 |
| Pozi-Drive, voldraad | | roestvaststaal A2 1.4567 | 67 |
| Achterwandschroef, tellerkop | | | 68 |
| T-Drive, voldraad | | verzinkt blauw, A3K | 68 |
| Pozi-Drive, voldraad | | verzinkt blauw, A3K | 69 |

| | | | |
|--|----------------------------------|--|----|
| Tellerkop | | | 70 |
| T-Drive, voldraad | verzinkt blauw, A3K |  | 71 |
| | roestvaststaal A2 1.4567 |  | 72 |
| T-Drive, deeldraad | NIEUW verzinkt blauw, A3K |  | 73 |
| | roestvaststaal A2 1.4567 |  | 75 |
| Tellerkop XL, T-Drive, deeldraad | verzinkt blauw, A3K |  | 76 |
| Combizeskantkop | | | 78 |
| Zeskantkop + T-Drive, voldraad | verzinkt blauw, A3K |  | 78 |
| Zeskantkop + T-Drive, deeldraad | verzinkt blauw, A3K |  | 79 |
| Cilinderkop | | | 80 |
| T-Drive, voldraad | NIEUW verzinkt blauw, A3K |  | 80 |
| Vloerplaatschroef, platverzonken kop met freesholtes | | | 82 |
| HECO-Drive, voldraad | verzinkt blauw, A3K |  | 83 |
| Vloerschroef, verzonken lenskop met freesribben | | | 84 |
| T-Drive, voldraad | verzinkt blauw, A3K |  | 85 |
| | roestvaststaal A2 1.4567 |  | 85 |
| Gevelschroef, verzonken lenskop | | | 86 |
| HECO-Drive, voldraad | roestvaststaal A2 1.4567 |  | 87 |
| Scharnierschroef, platverzonken kop met freesholtes / platverzonken kop | | | 88 |
| T-Drive, voldraad | NIEUW verzinkt blauw, A3K |  | 89 |
| Pozi-Drive, voldraad | NIEUW verzinkt blauw, A3K |  | 89 |
| HECO-Drive, voldraad | verzinkt blauw, A3K |  | 90 |
| | roestvaststaal A2 1.4567 |  | 90 |
| Pozi-Drive, voldraad | verzinkt blauw, A3K |  | 91 |
| | roestvaststaal A2 1.4567 |  | 91 |
| Glaslatschroef, verzonken lenskop met freesribben | | | 92 |
| T-Drive, deeldraad | verzinkt blauw, A3K |  | 93 |
| | verzinkt geel, A3L |  | 93 |
| | roestvaststaal A2 1.4567 |  | 94 |

| | | | |
|--|---|---|-----|
| Vlonderschroef, platverzonken kop met freesribben | | | 96 |
| HECO-Drive, deeldraad | roestvaststaal A2 1.4567 / A4 1.4578 |  | 97 |
| Vlonderschroef, verzonken lenskop | | | 98 |
| HECO-Drive, onderkopdraad | roestvaststaal A2 1.4567 / A4 1.4578 |  | 99 |
| Paalschroef, tellerkop | | | 100 |
| T-Drive, voldraad | HP-coating |  | 101 |
| Verbindingsschroef, tellerkop / platverzonken kop met freesholtes | | | 102 |
| T-Drive, voldraad | verzinkt blauw, A3K |  | 103 |
| HECO-Drive, voldraad | verzinkt blauw, A3K |  | 104 |
| HECO-TOPIX-plus TCS, platverzonken kop met freesribben 60° | | | 104 |
| HECO-Drive, voldraad |  verzinkt blauw, A3K |  | 105 |
| HECO-Drive, deeldraad |  verzinkt blauw, A3K |  | 105 |
| HECO-TOPIX-plus Therm, platverzonken kop met freesholtes | | | 106 |
| HECO-Drive, onderkopdraad | verzinkt blauw, A3K |  | 107 |
| HECO-TOPIX-plus CombiConnect, cilinderkop | | | 108 |
| T-Drive, CC-draad | verzinkt blauw, A3K |  | 109 |
| HECO-TOPIX-plus T Solar | | | 112 |
| T-Drive, onderkopdraad | roestvaststaal A2 1.4567 |  | 113 |
| HECO-UFIX® | | | 114 |
| MDF-schroef, platverzonken kop met freesholtes | | | 116 |
| HECO-Drive, deeldraad | verzinkt blauw, A2K |  | 117 |
| Houtbouw speciaal | | | 118 |
| HECO-WR speciale voldraadschroef, platverzonken kop | | | 120 |
| T-Drive, voldraad |  Durocoat |  | 121 |
| HECO-WS stalen deuvel, platverzonken cilinderkop | | | 122 |
| T-Drive, onderkopdraad | verzinkt blauw, A2K |  | 123 |
| HECO-WB draadstang | | | 124 |
| Zonder aandrijving, voldraad |  verzinkt blauw, A2K |  | 125 |

| | | | |
|---|--------------|--------------------------------------|---|
| HECO-VB Hout-beton-verbindingsschroef | | | 126 |
| TX-aandrijving E8, filet partiel | NIEUW | verzinkt blauw, A2K |  127 |
| MULTI-MONTI®-plus | | | 128 |
| Zeskantkop | | | 134 |
| MMS-plus SS/MMS-SS, met aangepaste ring MMS-plus S, zwaarlastanker | | verzinkt blauw, A2K of HP-coating |  134–136 |
| Zeskantkop, met sluitring | | | 137 |
| MMS-plus S, met sluitring DIN 440 | | verzinkt blauw, A2K |  137 |
| Voorsteekanker | | | 138 |
| MMS-plus V, met metr. buitendraad | | verzinkt blauw, A2K |  138 |
| Platverzonken kop | | | 139 |
| MMS-plus F, T-Drive | | verzinkt blauw, A2K |  139 |
| Montagerailschroef | | | 140 |
| MMS-plus MS, T-Drive | | verzinkt blauw, A2K |  140 |
| Stokanker | | | 141 |
| MMS-plus ST, met metr. buitendraad | | verzinkt blauw, A2K |  141 |
| Binnendraadanker | | | 142 |
| MMS-plus I, met metr. binnendraad en koppelbus | | verzinkt blauw, A2K |  142 |
| Rondkop | | | 143 |
| MMS-plus P, T-Drive | | verzinkt blauw, A2K |  143 |
| Kabelklemmschroef | | | 144 |
| MMS-plus KS, T-Drive | | verzinkt blauw, A2K |  144 |
| Ooganker | | | 144 |
| MMS-plus R | | verzinkt blauw, A2K |  144 |
| MULTI-MONTI-TimberConnect | | | 145 |
| MMS-TC, T-Drive | | verzinkt blauw, A2K |  145 |
| Schorenanker, zeskantkop | | | 146 |
| MMS-plus SSK, met aangepaste ring en conus | | verzinkt blauw, A2K |  147 |

| | | | |
|---|---|---|-----|
| MULTI-MONTI®-plus, roestvaststaal A4 | | | 148 |
| Zeskantkop | | | 149 |
| MMS-plus SS, met aangepaste ring | roestvaststaal A4 1.4401 |  | 149 |
| Platverzonken kop | | | 150 |
| MMS-plus F, T-Drive | roestvaststaal A4 1.4401 |  | 150 |
| Rondkop | | | 151 |
| MMS-plus P, T-Drive | roestvaststaal A4 1.4401 |  | 151 |
| HECO-accessoires | | | 152 |
| Assortimentskoffers | | | 154 |
| HECO-assortimentskoffers L-Boxx-systeem | NIEUW voorzien en leeg, verschillende maten |  | 154 |
| Bits en bithouders | | | 156 |
| Schroefbits en bitsets | NIEUW bits 25 en 70 mm, HECO- en Pozi-Drive, HECO-Bit-Selector |  | 156 |
| Toonbankdisplays en blistertrays met HECO-Drive-bits | NIEUW met standaardbits 25 mm of lange bits 70 mm |  | 158 |
| Bithouders en schroevendraaier | NIEUW HECO-ClicFix HECO-MagicFlip HECO-Stubby |  | 156 |
| Montageaccessoires houtbouw speciaal | | | 160 |
| Montageaccessoires voor HECO-WR voldraadschroeven | NIEUW HECO-PowerLock, bits en adapters |  | 160 |
| Montageaccessoires voor HECO-WS stalen deuvels | NIEUW montagegereedschappen, bithouders en vervangingsbits |  | 161 |
| Montageaccessoires voor HECO-WB draadstangen | NIEUW inschroefhuizen en boorsystemen |  | 162 |
| Montageaccessoires voor HECO-VB hout-beton-verbindingsschroeven | NIEUW montagegereedschappen en vervangingsbits |  | 164 |

| | | | |
|---|--|---|-----|
| Meethulzen | | | 165 |
| Zetgereedschap voor MULTI-MONTI-TimberConnect | voor MMS-TimberConnect met Ø7,5, Ø10 en Ø12 mm |  | 165 |
| Meethulzen voor meervoudig gebruik van de MULTI-MONTI®-plus | voor MMS-plus met Ø10, Ø12, Ø16 en Ø20 mm |  | 166 |
| HECO-vlonder assortiment | | | 168 |
| HECO-vlondergeleidersets | kleine set met middengeleider, grote set met middengeleider, kleine set met randgeleider |  | 168 |
| HECO-clipperset | HECO-clipper met HECO-TOPIX-plus clipperschroeven in roestvaststaal A2 |  | 170 |
| HECO-vlonderpads | vlonderpads 3, 8 en 20 mm |  | 171 |
| HECO-stelvoet | stelvoet, hoogte: 35–70 mm stelvoet, hoogte: 65–155 mm |  | 172 |
| HECO-afstandhouders | HECO-afstandhouders 3, 5 en 7 mm |  | 173 |
| HECO-spanner | spanner voor vlonderplanken met drie afstandhouders |  | 174 |
| HECO-vlonderboor | vlonderboor & vervangende boren |  | 175 |
| Accessoires voor HECO-TOPIX-plus | | | 176 |
| Onderlegschijven voor HECO-TOPIX-plus schroeven met platverzonken kop | Onderlegschijven, Ø 25 mm Onderlegschijven, Ø 30 mm |  | 176 |
| Inschroefhulp voor HECO-TOPIX-plus houtbouwschroeven | voor 60°- en 45°-inschroeven |  | 177 |
| Plastic afdekkapjes | voor Pozi-Drive, Pozi-Drive met kogatboring en T-/HECO-Drive |  | 178 |
| Rekenhulp | | | 180 |
| HECO-HCS 4.0 calculatie software | als download of als CD verkrijgbaar |  | 180 |





HECO-TOPIX[®]-plus

DE SCHROEF MET TECHNOLOGISCHE VOORSPRONG.





HECO-TOPIX®-plus

Product informatie

HECO-TOPIX-plus is een echte schroef highlight en verenigt gebundelde technologische knowhow en veel concrete voordelen voor de gebruiker in één type schroef. Het geheim: voor HECO-TOPIX-plus hebben wij de beste eigenschappen uit vier HECO-assortimenten bij elkaar gebracht!

Met de innovatieve eigenschappen HECO-Drive, GripFit, MagicClose, PerfectPitch, een nieuw, uniform bitmaat concept en hoogwaardige systeemtoebehoren is HECO-TOPIX-plus de perfecte schroef voor nagenoeg alle toepassingen.



Maakt het beste beter.

Platverzonken kop met freesholtes

Uitstekende freeseigenschappen in hout. Geen beschadiging van het oppervlak bij metalen beslag.

MagicClose®

Gepatenteerde voldraad trekt houten onderdelen spleetvrij samen zonder voorspannen



HECO-TOPIX-plus-punt

Maakt voorboren overbodig en vermindert het risico van splijten van het hout

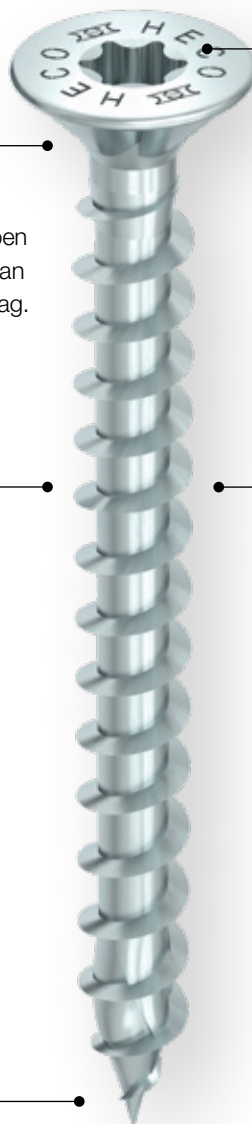

GripFit®

HECO-Drive maakt werken met één hand mogelijk



PerfectPitch®

Optimale schroefdraadspoed voor elke schroeflengte



Video





Toepassingsvoorbeelden

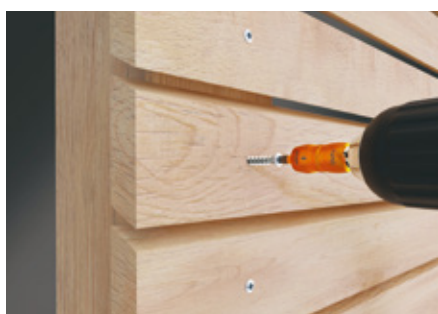

Gevelschroefverbinding



Kastschroefverbinding



Vastzetten van vloerplanken



Bevestiging van regelwerk t.b.v. installaties



Isolatiemateriaal op dakspanten

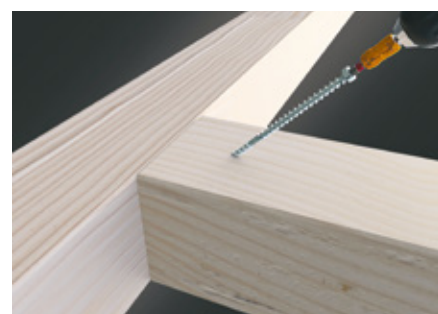

Hoofdhulpligger verbinding

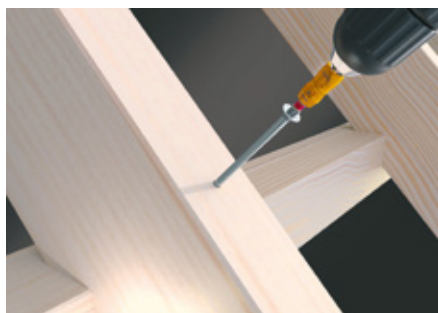

Spantbevestiging



OSB-beplating



Bevestiging van beslag



Uitvoering: platverzonken kop met freesholtes

Aandrijving: T-Drive

Draadtype: variabele voldraad

Materiaal: koolstofstaal

Oppervlakte: verzinkt blauw, A3K **CHROME (VI) FREE +**

Kleurcode op het HECO-etiket

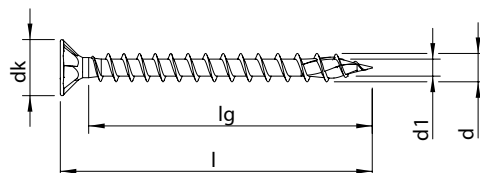

| Afmeting d x l [mm] | Draadlengte lg [mm] | Kopdiameter dk [mm] | Aandrijving | ETA | Artikelnummer | Aantal per verpakking [st.] | Type verpakking | Aantal per omverpakking [st.] |
|---|---------------------|---------------------|-------------|-----------------------|------------------------------------|-----------------------------|-----------------|-------------------------------|
| 3,0  | 12 | 8 | 5,9 | T-10 | 62685 NIEUW | 200 | SKV | 4.800 |
| | 12 | 8 | 5,9 | T-10 | 60039 | 1.000 | VARIANTA | 10.000 |
| | 16 | 12 | 5,9 | T-10 | 60061 | 200 | SKV | 4.800 |
| | 16 | 12 | 5,9 | T-10 | 60062 | 1.000 | VARIANTA | 10.000 |
| | 20 | 16 | 5,9 | T-10 | 60081 | 200 | SKV | 4.800 |
| | 20 | 16 | 5,9 | T-10 | 60082 | 1.000 | VARIANTA | 10.000 |
| | 25 | 21 | 5,9 | T-10 | 60099 | 200 | SKV | 4.800 |
| | 25 | 21 | 5,9 | T-10 | 60100 | 1.000 | VARIANTA | 10.000 |
| | 30 | 26 | 5,9 | T-10 | 60116 | 200 | SKV | 4.800 |
| | 30 | 26 | 5,9 | T-10 | 60117 | 1.000 | VARIANTA | 10.000 |
| | 35 | 31 | 5,9 | T-10 | 60138 | 200 | SKV | 4.800 |
| | 35 | 31 | 5,9 | T-10 | 60139 | 1.000 | VARIANTA | 10.000 |
| | 40 | 36 | 5,9 | T-10 | 60151 | 200 | SKV | 4.000 |
| | 40 | 36 | 5,9 | T-10 | 60152 | 500 | VARIANTA | 5.000 |
| | 45 | 41 | 5,9 | T-10 | 60162 | 200 | SKV | 4.000 |
| 45 | 41 | 5,9 | T-10 | 60163 | 500 | VARIANTA | 5.000 | |

Uitvoering: platverzonken kop met freesholtes

Aandrijving: HECO-Drive *

Draadtype: variabele voldraad

Materiaal: koolstofstaal

Oppervlakte: verzinkt blauw, A3K **CHROME (VI) FREE +**

Kleurcode op het HECO-etiket

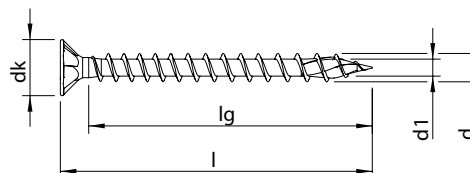

| Afmeting d x l [mm] | Draadlengte lg [mm] | Kopdiameter dk [mm] | Aandrijving | ETA | Artikelnummer | Aantal per verpakking [st.] | Type verpakking | Aantal per omverpakking [st.] |
|---------------------|---------------------|---------------------|-------------|-------------------------|------------------------------------|-----------------------------|-----------------|-------------------------------|
| 3,5 | 12 | 7 | 7,3 | HD-20 | 60175 | 200 | SKV | 4.800 |
| | 12 | 7 | 7,3 | HD-20 | 62686 NIEUW | 500 | VARIANTA | 5.000 |
| | 12 | 7 | 7,3 | HD-20 | 60176 | 1.000 | VARIANTA | 10.000 |
| | 15 | 10 | 7,3 | HD-20 | 60186 | 200 | SKV | 4.800 |
| | 15 | 10 | 7,3 | HD-20 | 60187 | 1.000 | VARIANTA | 10.000 |
| | 16 | 11 | 7,3 | HD-20 | 60194 | 200 | SKV | 4.800 |
| | 16 | 11 | 7,3 | HD-20 | 60195 | 1.000 | VARIANTA | 10.000 |
| | 20 | 15 | 7,3 | HD-20 | • 60213 | 200 | SKV | 4.800 |
| | 20 | 15 | 7,3 | HD-20 | • 60214 | 1.000 | VARIANTA | 10.000 |
| | 25 | 20 | 7,3 | HD-20 | • 60230 | 200 | SKV | 4.800 |
| | 25 | 20 | 7,3 | HD-20 | • 60231 | 1.000 | VARIANTA | 10.000 |
| | 30 | 25 | 7,3 | HD-20 | • 60255 | 200 | SKV | 4.800 |
| | 30 | 25 | 7,3 | HD-20 | • 60256 | 1.000 | VARIANTA | 10.000 |
| | 35 | 30 | 7,3 | HD-20 | • 60278 | 200 | SKV | 4.000 |
| | 35 | 30 | 7,3 | HD-20 | • 60279 | 1.000 | VARIANTA | 10.000 |
| | 40 | 35 | 7,3 | HD-20 | • 60302 | 200 | SKV | 4.000 |
| | 40 | 35 | 7,3 | HD-20 | • 60303 | 500 | VARIANTA | 5.000 |
| | 45 | 40 | 7,3 | HD-20 | • 60320 | 200 | SKV | 4.000 |
| | 45 | 40 | 7,3 | HD-20 | • 60321 | 500 | VARIANTA | 5.000 |
| | 50 | 45 | 7,3 | HD-20 | • 60336 | 200 | SKV | 4.000 |
| 50 | 45 | 7,3 | HD-20 | • 60337 | 500 | VARIANTA | 5.000 | |

* Alle schroeven met HECO-Drive zijn 100% compatibel met conventionele TX-bits.
Het GripFit-effect is alleen gegarandeerd bij gebruik met bijpassende HECO-Drive-bits.



Uitvoering: platverzonken kop met freesholtes

Aandrijving: HECO-Drive *

Draadtype: variabele voldraad

Materiaal: koolstofstaal

Oppervlakte: verzinkt blauw, A3K **CHROME (VI) FREE +**

Kleurcode op het HECO-etiket

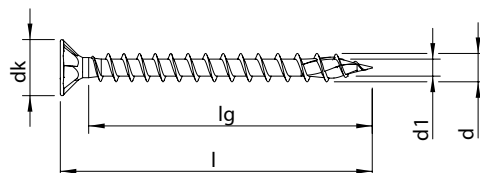

| Afmeting d x l [mm] | Draadlengte lg [mm] | Kopdiameter dk [mm] | Aandrijving | ETA | Artikelnummer | Aantal per verpakking [st.] | Type verpakking | Aantal per omverpakking [st.] |
|---------------------|---------------------|---------------------|-------------|-------------------------|-------------------------|-----------------------------|-----------------|-------------------------------|
| 4,0 | 15 | 10 | 7,9 | HD-20 | 60364 | 200 | SKV | 4.800 |
| | 15 | 10 | 7,9 | HD-20 | 60365 | 1.000 | VARIANTA | 10.000 |
| | 16 | 11 | 7,9 | HD-20 | 60372 | 200 | SKV | 4.800 |
| | 16 | 11 | 7,9 | HD-20 | 60373 | 1.000 | VARIANTA | 10.000 |
| | 20 | 15 | 7,9 | HD-20 | 60389 | 200 | SKV | 4.800 |
| | 20 | 15 | 7,9 | HD-20 | 60390 | 1.000 | VARIANTA | 10.000 |
| | 25 | 20 | 7,9 | HD-20 | • 60406 | 200 | SKV | 4.800 |
| | 25 | 20 | 7,9 | HD-20 | • 60407 | 1.000 | VARIANTA | 10.000 |
| | 30 | 25 | 7,9 | HD-20 | • 60428 | 200 | SKV | 4.800 |
| | 30 | 25 | 7,9 | HD-20 | • 60429 | 1.000 | VARIANTA | 10.000 |
| | 35 | 30 | 7,9 | HD-20 | • 60452 | 200 | SKV | 4.000 |
| | 35 | 30 | 7,9 | HD-20 | • 60453 | 500 | VARIANTA | 5.000 |
| | 40 | 35 | 7,9 | HD-20 | • 60475 | 200 | SKV | 4.000 |
| | 40 | 35 | 7,9 | HD-20 | • 60476 | 500 | VARIANTA | 5.000 |
| | 40 | 35 | 7,9 | HD-20 | • 60477 | 1.000 | VARIANTA | 10.000 |
| | 45 | 40 | 7,9 | HD-20 | • 60501 | 200 | SKV | 4.000 |
| | 45 | 40 | 7,9 | HD-20 | • 60502 | 500 | VARIANTA | 5.000 |
| | 50 | 45 | 7,9 | HD-20 | • 60525 | 200 | SKV | 4.000 |
| | 50 | 45 | 7,9 | HD-20 | • 60526 | 500 | VARIANTA | 5.000 |
| 55 | 50 | 7,9 | HD-20 | • 60547 | 200 | VARIANTA | 2.000 | |
| 60 | 55 | 7,9 | HD-20 | • 60556 | 200 | VARIANTA | 2.000 | |
| 70 | 65 | 7,9 | HD-20 | • 60570 | 200 | VARIANTA | 2.000 | |

* Alle schroeven met HECO-Drive zijn 100% compatibel met conventionele TX-bits.
Het GripFit-effect is alleen gegarandeerd bij gebruik met bijpassende HECO-Drive-bits.

Uitvoering: platverzonken kop met freesholtes

Aandrijving: HECO-Drive *

Draadtype: variabele voldraad

Materiaal: koolstofstaal

Oppervlakte: verzinkt blauw, A3K **CHROME (VI) FREE +**

Kleurcode op het HECO-etiket

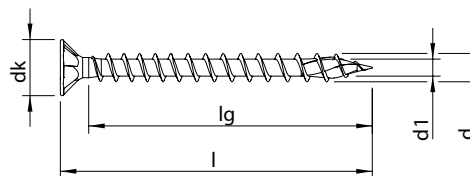

| Afmeting d x l [mm] | Draadlengte lg [mm] | Kopdiameter dk [mm] | Aandrijving | ETA | Artikelnummer | Aantal per verpakking [st.] | Type verpakking | Aantal per omverpakking [st.] |
|---------------------|---------------------|---------------------|--------------|--|--|-----------------------------|-----------------|-------------------------------|
| 4,5 | 20 | 15 | 8,9 | HD-20 | 60598 | 200 | SKV | 4.800 |
| | 20 | 15 | 8,9 | HD-20 | 60599 | 1.000 | VARIANTA | 10.000 |
| | 25 | 20 | 8,9 | HD-20 | 60616 | 200 | SKV | 4.800 |
| | 25 | 20 | 8,9 | HD-20 | 60617 | 500 | VARIANTA | 5.000 |
| | 30 | 25 | 8,9 | HD-20 | 60633 | 200 | SKV | 4.000 |
| | 30 | 25 | 8,9 | HD-20/T-25** | 60634/62289** NIEUW | 500 | VARIANTA | 5.000 |
| | 35 | 30 | 8,9 | HD-20 | 60655 | 200 | SKV | 4.000 |
| | 35 | 30 | 8,9 | HD-20/T-25** | 60656/62290** NIEUW | 500 | VARIANTA | 5.000 |
| | 40 | 35 | 8,9 | HD-20 | 60678 | 200 | SKV | 4.000 |
| | 40 | 35 | 8,9 | HD-20/T-25** | 60679/62291** NIEUW | 500 | VARIANTA | 5.000 |
| | 45 | 40 | 8,9 | HD-20 | 60702 | 200 | SKV | 4.000 |
| | 45 | 40 | 8,9 | HD-20/T-25** | 60703/62292** NIEUW | 500 | VARIANTA | 5.000 |
| | 50 | 45 | 8,9 | HD-20/T-25** | 60725/62293** NIEUW | 200 | VARIANTA | 2.000 |
| | 55 | 50 | 8,9 | HD-20 | 60742 | 200 | VARIANTA | 2.000 |
| | 60 | 55 | 8,9 | HD-20/T-25** | 60755/62294** NIEUW | 200 | VARIANTA | 2.000 |
| 70 | 65 | 8,9 | HD-20/T-25** | 60772/62295** NIEUW | 200 | VARIANTA | 2.000 | |
| 80 | 75 | 8,9 | HD-20/T-25** | 60783/62296** NIEUW | 200 | VARIANTA | 2.000 | |

* Alle schroeven met HECO-Drive zijn 100% compatibel met conventionele TX-bits.
Het GripFit-effect is alleen gegarandeerd bij gebruik met bijpassende HECO-Drive-bits.

** Alternatieve houtbouwvariant met aandrijving T-25 (zonder GripFit-effect)



Uitvoering: platverzonken kop met freesholtes

Aandrijving: HECO-Drive *

Draadtype: variabele voldraad

Materiaal: koolstofstaal

Oppervlakte: verzinkt blauw, A3K **CHROME (VI) FREE +**

Kleurcode op het HECO-etiket

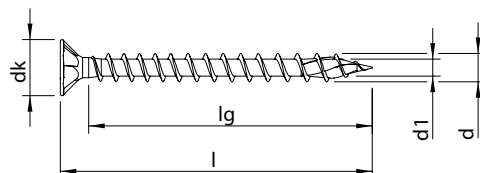

| Afmeting d x l [mm] | Draadlengte lg [mm] | Kopdiameter dk [mm] | Aandrijving | ETA | Artikelnummer | Aantal per verpakking [st.] | Type verpakking | Aantal per omverpakking [st.] | |
|---------------------|---------------------|---------------------|--------------|---------------------------------|---------------------------------|-----------------------------|-----------------|-------------------------------|-------|
| 5,0 | 20 | 14 | 9,6 | HD-20 | 60806 | 200 | SKV | 4.800 | |
| | 20 | 14 | 9,6 | HD-20 | 60807 | 500 | VARIANTA | 5.000 | |
| | 25 | 19 | 9,6 | HD-20 | 60818 | 200 | SKV | 4.000 | |
| | 25 | 19 | 9,6 | HD-20 | 60819 | 500 | VARIANTA | 5.000 | |
| | 30 | 24 | 9,6 | HD-20 | • 60832 | 200 | SKV | 4.000 | |
| | 30 | 24 | 9,6 | HD-20/T-25** | • 60833/62297** | NIEUW | 500 | VARIANTA | 5.000 |
| | 35 | 29 | 9,6 | HD-20 | • 60851 | 200 | SKV | 4.000 | |
| | 35 | 29 | 9,6 | HD-20/T-25** | • 60852/62298** | NIEUW | 500 | VARIANTA | 5.000 |
| | 40 | 34 | 9,6 | HD-20 | • 60869 | 200 | SKV | 4.000 | |
| | 40 | 34 | 9,6 | HD-20/T-25** | • 60870/62299** | NIEUW | 500 | VARIANTA | 5.000 |
| | 45 | 39 | 9,6 | HD-20/T-25** | • 60887/62300** | NIEUW | 200 | VARIANTA | 2.000 |
| | 50 | 44 | 9,6 | HD-20/T-25** | • 60900/62301** | NIEUW | 200 | VARIANTA | 2.000 |
| | 55 | 49 | 9,6 | HD-20 | • 60914 | 200 | VARIANTA | 2.000 | |
| | 60 | 54 | 9,6 | HD-20/T-25** | • 60924/62302** | NIEUW | 200 | VARIANTA | 2.000 |
| | 70 | 64 | 9,6 | HD-20/T-25** | • 60940/62303** | NIEUW | 200 | VARIANTA | 2.000 |
| | 80 | 74 | 9,6 | HD-20/T-25** | • 60953/62304** | NIEUW | 200 | VARIANTA | 2.000 |
| 90 | 84 | 9,6 | HD-20 | • 60964 | 200 | VARIANTA | 2.000 | | |
| 100 | 94 | 9,6 | HD-20/T-25** | • 60972/62305** | NIEUW | 100 | VARIANTA | 1.000 | |
| 120 | 114 | 9,6 | HD-20 | • 60984 | 100 | VARIANTA | 1.000 | | |
| 6,0 | 30 | 23 | 11,7 | HD-30 | 60996 | 200 | VARIANTA | 2.000 | |
| | 35 | 28 | 11,7 | HD-30 | • 61002 | 200 | VARIANTA | 2.000 | |
| | 40 | 33 | 11,7 | HD-30 | • 61006 | 200 | VARIANTA | 2.000 | |
| | 45 | 38 | 11,7 | HD-30 | • 61020 | 200 | VARIANTA | 2.000 | |
| | 50 | 43 | 11,7 | HD-30 | • 61028 | 200 | VARIANTA | 2.000 | |
| | 60 | 53 | 11,7 | HD-30 | • 61051 | 200 | VARIANTA | 2.000 | |
| | 70 | 63 | 11,7 | HD-30 | • 61072 | 200 | VARIANTA | 1.000 | |
| | 80 | 73 | 11,7 | HD-30 | • 61084 | 100 | VARIANTA | 1.000 | |
| | 90 | 83 | 11,7 | HD-30 | • 61098 | 100 | VARIANTA | 1.000 | |
| | 100 | 93 | 11,7 | HD-30 | • 61107 | 100 | VARIANTA | 1.000 | |
| | 110 | 103 | 11,7 | HD-30 | • 61121 | 100 | VARIANTA | 1.000 | |
| 120 | 113 | 11,7 | HD-30 | • 61128 | 100 | VARIANTA | 1.000 | | |
| 140 | 133 | 11,7 | HD-30 | • 61144 | 100 | VARIANTA | 500 | | |
| 160 | 153 | 11,7 | HD-30 | • 61160 | 100 | VARIANTA | 800 | | |

* Alle schroeven met HECO-Drive zijn 100% compatibel met conventionele TX-bits.
Het GripFit-effect is alleen gegarandeerd bij gebruik met bijpassende HECO-Drive-bits.

** Alternatieve houtbouwvariant met aandrijving T-25 (zonder GripFit-effect)

Uitvoering: platverzonken kop met freesholtes

Aandrijving: HECO-Drive*

Draadtype: voldraad

Materiaal: koolstofstaal

Oppervlakte: verzinkt blauw, A3K **CHROME (VI) FREE +**

Kleurcode op het HECO-etiket

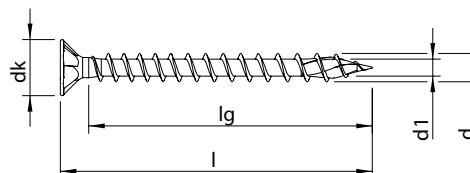

| Afmeting d x l [mm] | Draadlengte lg [mm] | Kopdiameter dk [mm] | Aandrijving | ETA | Artikelnummer | Aantal per verpakking [st.] | Type verpakking | Aantal per omverpakking [st.] | |
|---------------------|---------------------|---------------------|-------------|-------|---------------|-----------------------------|-----------------|-------------------------------|-----|
| 8,0 | 60 | 50 | 14,8 | HD-40 | ● | 61956 | 100 | VARIANTA | 400 |
| | 80 | 70 | 14,8 | HD-40 | ● | 61957 | 100 | VARIANTA | 400 |
| | 100 | 90 | 14,8 | HD-40 | ● | 61958 | 100 | VARIANTA | 400 |
| | 120 | 110 | 14,8 | HD-40 | ● | 61266 | 100 | VARIANTA | 400 |
| | 160 | 150 | 14,8 | HD-40 | ● | 61289 | 100 | VARIANTA | 400 |
| | 180 | 170 | 14,8 | HD-40 | ● | 61301 | 100 | VARIANTA | 200 |
| | 200 | 190 | 14,8 | HD-40 | ● | 61314 | 100 | VARIANTA | 200 |
| | 220 | 210 | 14,8 | HD-40 | ● | 61326 | 50 | VARIANTA | 200 |
| | 240 | 230 | 14,8 | HD-40 | ● | 61337 | 50 | VARIANTA | 200 |
| | 260 | 250 | 14,8 | HD-40 | ● | 61348 | 50 | VARIANTA | 200 |
| | 280 | 270 | 14,8 | HD-40 | ● | 61361 | 50 | VARIANTA | 200 |
| | 300 | 290 | 14,8 | HD-40 | ● | 61374 | 50 | VARIANTA | 200 |
| | 340 | 330 | 14,8 | HD-40 | ● | 61396 | 50 | VARIANTA | 200 |
| | 380 | 370 | 14,8 | HD-40 | ● | 61418 | 50 | VARIANTA | 100 |
| 10,0 | 120 | 108 | 18,5 | HD-40 | ● | 61488 | 50 | VARIANTA | 200 |
| | 160 | 148 | 18,5 | HD-40 | ● | 61506 | 50 | VARIANTA | 200 |
| | 200 | 188 | 18,5 | HD-40 | ● | 61523 | 50 | VARIANTA | 200 |
| | 220 | 208 | 18,5 | HD-40 | ● | 61532 | 50 | VARIANTA | 200 |
| | 240 | 228 | 18,5 | HD-40 | ● | 61540 | 50 | VARIANTA | 100 |
| | 260 | 248 | 18,5 | HD-40 | ● | 61548 | 50 | VARIANTA | 100 |
| | 280 | 268 | 18,5 | HD-40 | ● | 61557 | 50 | VARIANTA | 100 |
| | 300 | 288 | 18,5 | HD-40 | ● | 61568 | 50 | VARIANTA | 100 |
| | 340 | 328 | 18,5 | HD-40 | ● | 61585 | 50 | VARIANTA | 100 |
| | 380 | 368 | 18,5 | HD-40 | ● | 61596 | 50 | VARIANTA | 100 |

* Alle schroeven met HECO-Drive zijn 100% compatibel met conventionele TX-bits.
Het GripFit-effect is alleen gegarandeerd bij gebruik met bijpassende HECO-Drive-bits.



Uitvoering: platverzonken kop met freesholtes

Aandrijving: HECO-Drive *

Draadtype: variabele voldraad

Materiaal: koolstofstaal

Oppervlakte: verzinkt geel, A3L **CHROME (VI) FREE +**

Kleurcode op het HECO-etiket

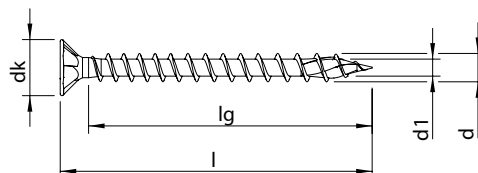

| Afmeting d x l [mm] | Draadlengte lg [mm] | Kopdiameter dk [mm] | Aandrijving | ETA | Artikelnummer | Aantal per verpakking [st.] | Type verpakking | Aantal per omverpakking [st.] |
|---------------------|---------------------|---------------------|-------------|-------------------------|-------------------------|-----------------------------|-----------------|-------------------------------|
| 3,5 ★ | 12 | 7 | 7,3 | HD-20 | 60177 | 1.000 | VARIANTA | 10.000 |
| | 16 | 11 | 7,3 | HD-20 | 60197 | 1.000 | VARIANTA | 10.000 |
| | 20 | 15 | 7,3 | HD-20 | ● 60216 | 1.000 | VARIANTA | 10.000 |
| | 25 | 20 | 7,3 | HD-20 | ● 60233 | 1.000 | VARIANTA | 10.000 |
| | 30 | 25 | 7,3 | HD-20 | ● 60258 | 1.000 | VARIANTA | 10.000 |
| | 35 | 30 | 7,3 | HD-20 | ● 60281 | 1.000 | VARIANTA | 10.000 |
| | 40 | 35 | 7,3 | HD-20 | ● 60305 | 500 | VARIANTA | 5.000 |
| | 45 | 40 | 7,3 | HD-20 | ● 60323 | 500 | VARIANTA | 5.000 |
| | 50 | 45 | 7,3 | HD-20 | ● 60339 | 500 | VARIANTA | 5.000 |
| 4,0 ★ | 16 | 11 | 7,9 | HD-20 | 60375 | 1.000 | VARIANTA | 10.000 |
| | 20 | 15 | 7,9 | HD-20 | 60392 | 1.000 | VARIANTA | 10.000 |
| | 25 | 20 | 7,9 | HD-20 | ● 60410 | 1.000 | VARIANTA | 10.000 |
| | 30 | 25 | 7,9 | HD-20 | ● 60431 | 1.000 | VARIANTA | 10.000 |
| | 35 | 30 | 7,9 | HD-20 | ● 60455 | 500 | VARIANTA | 5.000 |
| | 40 | 35 | 7,9 | HD-20 | ● 60479 | 500 | VARIANTA | 5.000 |
| | 45 | 40 | 7,9 | HD-20 | ● 60504 | 500 | VARIANTA | 5.000 |
| | 50 | 45 | 7,9 | HD-20 | ● 60528 | 500 | VARIANTA | 5.000 |
| | 60 | 55 | 7,9 | HD-20 | ● 60557 | 200 | VARIANTA | 2.000 |
| 70 | 65 | 7,9 | HD-20 | ● 60571 | 200 | VARIANTA | 2.000 | |
| 4,5 ★ | 20 | 15 | 8,9 | HD-20 | 60601 | 1.000 | VARIANTA | 10.000 |
| | 25 | 20 | 8,9 | HD-20 | ● 60619 | 500 | VARIANTA | 5.000 |
| | 30 | 25 | 8,9 | HD-20 | ● 60636 | 500 | VARIANTA | 5.000 |
| | 35 | 30 | 8,9 | HD-20 | ● 60658 | 500 | VARIANTA | 5.000 |
| | 40 | 35 | 8,9 | HD-20 | ● 60681 | 500 | VARIANTA | 5.000 |
| | 45 | 40 | 8,9 | HD-20 | ● 60705 | 500 | VARIANTA | 5.000 |
| | 50 | 45 | 8,9 | HD-20 | ● 60727 | 200 | VARIANTA | 2.000 |
| | 60 | 55 | 8,9 | HD-20 | ● 60756 | 200 | VARIANTA | 2.000 |
| | 70 | 65 | 8,9 | HD-20 | ● 60773 | 200 | VARIANTA | 2.000 |

* Alle schroeven met HECO-Drive zijn 100% compatibel met conventionele TX-bits.
Het GripFit-effect is alleen gegarandeerd bij gebruik met bijpassende HECO-Drive-bits.

Uitvoering: platverzonken kop met freesholtes

Aandrijving: HECO-Drive*

Draadtype: variabele voldraad

Materiaal: koolstofstaal

Oppervlakte: verzinkt geel, A3L **CHROME (VI) FREE** +

Kleurcode op het HECO-etiket

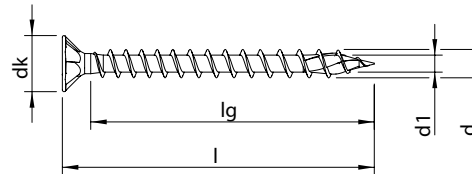

| Afmeting d x l [mm] | Draadlengte lg [mm] | Kopdiameter dk [mm] | Aandrijving | ETA | Artikelnummer | Aantal per verpakking [st.] | Type verpakking | Aantal per omverpakking [st.] |
|---------------------|---------------------|---------------------|-------------|-------|-------------------------|-----------------------------|-----------------|-------------------------------|
| 5,0 | 20 | 14 | 9,6 | HD-20 | 60808 | 500 | VARIANTA | 5.000 |
| | 25 | 19 | 9,6 | HD-20 | 60820 | 500 | VARIANTA | 5.000 |
| | 30 | 24 | 9,6 | HD-20 | • 60836 | 500 | VARIANTA | 5.000 |
| | 35 | 29 | 9,6 | HD-20 | • 60854 | 500 | VARIANTA | 5.000 |
| | 40 | 34 | 9,6 | HD-20 | • 60872 | 500 | VARIANTA | 5.000 |
| | 45 | 39 | 9,6 | HD-20 | • 60888 | 200 | VARIANTA | 2.000 |
| | 50 | 44 | 9,6 | HD-20 | • 60902 | 200 | VARIANTA | 2.000 |
| | 60 | 54 | 9,6 | HD-20 | • 60926 | 200 | VARIANTA | 2.000 |
| | 70 | 64 | 9,6 | HD-20 | • 60942 | 200 | VARIANTA | 2.000 |
| 6,0 | 30 | 23 | 11,7 | HD-30 | 60997 | 200 | VARIANTA | 2.000 |
| | 40 | 33 | 11,7 | HD-30 | • 61007 | 200 | VARIANTA | 2.000 |
| | 45 | 38 | 11,7 | HD-30 | • 61021 | 200 | VARIANTA | 2.000 |
| | 50 | 43 | 11,7 | HD-30 | • 61030 | 200 | VARIANTA | 2.000 |
| | 60 | 53 | 11,7 | HD-30 | • 61053 | 200 | VARIANTA | 2.000 |
| | 70 | 63 | 11,7 | HD-30 | • 61073 | 200 | VARIANTA | 1.000 |

* Alle schroeven met HECO-Drive zijn 100% compatibel met conventionele TX-bits.
Het GripFit-effect is alleen gegarandeerd bij gebruik met bijpassende HECO-Drive-bits.



Uitvoering: platverzonken kop met freesholtes

Aandrijving: HECO-Drive *



Draadtype: variabele voldraad

Materiaal: roestvaststaal A2 1.4567

Oppervlakte: blank, glijcoating

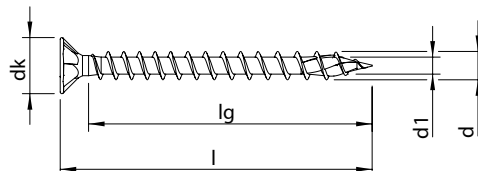
Kleurcode op het HECO-etiket



| Afmeting d x l [mm] | Draadlengte lg [mm] | Kopdiameter dk [mm] | Aandrijving | ETA | Artikelnummer | Aantal per verpakking [st.] | Type verpakking | Aantal per omverpakking [st.] |
|---|---------------------|---------------------|-------------|-------|-------------------------|-----------------------------|-----------------|-------------------------------|
| 3,0  | 20 | 16 | 5,9 | T-10 | 62013 | 200 | SKV | 4.800 |
| | 25 | 21 | 5,9 | T-10 | 62014 | 200 | SKV | 4.800 |
| | 30 | 26 | 5,9 | T-10 | 62015 | 200 | SKV | 4.800 |
| | 35 | 31 | 5,9 | T-10 | 62016 | 200 | SKV | 4.800 |
| 3,5  | 16 | 11 | 7,3 | HD-20 | 62017 | 200 | SKV | 4.800 |
| | 20 | 15 | 7,3 | HD-20 | • 62018 | 200 | SKV | 4.800 |
| | 25 | 20 | 7,3 | HD-20 | • 62019 | 200 | SKV | 4.800 |
| | 30 | 25 | 7,3 | HD-20 | • 62020 | 200 | SKV | 4.800 |
| | 35 | 30 | 7,3 | HD-20 | • 62021 | 200 | SKV | 4.000 |
| | 40 | 35 | 7,3 | HD-20 | • 62022 | 200 | SKV | 4.000 |
| 4,0  | 20 | 15 | 7,9 | HD-20 | 62023 | 200 | SKV | 4.800 |
| | 25 | 20 | 7,9 | HD-20 | • 62024 | 200 | SKV | 4.800 |
| | 30 | 25 | 7,9 | HD-20 | • 62025 | 200 | SKV | 4.800 |
| | 35 | 30 | 7,9 | HD-20 | • 62026 | 200 | SKV | 4.000 |
| | 40 | 35 | 7,9 | HD-20 | • 62027 | 200 | SKV | 4.000 |
| | 45 | 40 | 7,9 | HD-20 | • 62028 | 200 | SKV | 4.000 |
| | 50 | 45 | 7,9 | HD-20 | • 62029 | 200 | SKV | 4.000 |

* Alle schroeven met HECO-Drive zijn 100% compatibel met conventionele TX-bits.
Het GripFit-effect is alleen gegarandeerd bij gebruik met bijpassende HECO-Drive-bits.

Uitvoering: platverzonken kop met freesholtes

Aandrijving: HECO-Drive *

Draadtype: variabele voldraad

Materiaal: roestvaststaal A2 1.4567

Oppervlakte: blank, glijcoating

Kleurcode op het HECO-etiket

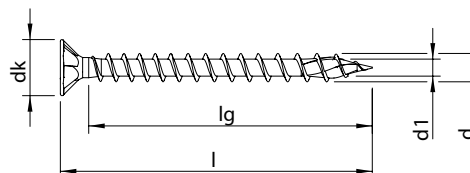

| Afmeting d x l [mm] | Draadlengte lg [mm] | Kopdiameter dk [mm] | Aandrijving | ETA | Artikelnummer | Aantal per verpakking [st.] | Type verpakking | Aantal per omverpakking [st.] | |
|---------------------|---------------------|---------------------|-------------|-------|---------------|-----------------------------|-----------------|-------------------------------|-------|
| 4,5 | 25 | 20 | 8,9 | HD-20 | • | 62030 | 200 | SKV | 4.800 |
| | 30 | 25 | 8,9 | HD-20 | • | 62031 | 200 | SKV | 4.000 |
| | 35 | 30 | 8,9 | HD-20 | • | 62032 | 200 | SKV | 4.000 |
| | 40 | 35 | 8,9 | HD-20 | • | 62033 | 200 | SKV | 4.000 |
| | 45 | 40 | 8,9 | HD-20 | • | 62034 | 200 | SKV | 4.000 |
| | 50 | 45 | 8,9 | HD-20 | • | 62035 | 200 | VARIANTA | 2.000 |
| 5,0 | 25 | 19 | 9,6 | HD-20 | • | 62036 | 200 | SKV | 4.000 |
| | 30 | 24 | 9,6 | HD-20 | • | 62037 | 200 | SKV | 4.000 |
| | 35 | 29 | 9,6 | HD-20 | • | 62038 | 200 | SKV | 4.000 |
| | 40 | 34 | 9,6 | HD-20 | • | 62039 | 200 | SKV | 4.000 |
| | 45 | 39 | 9,6 | HD-20 | • | 62040 | 200 | VARIANTA | 2.000 |
| | 50 | 44 | 9,6 | HD-20 | • | 62041 | 200 | VARIANTA | 2.000 |
| | 60 | 54 | 9,6 | HD-20 | • | 62042 | 200 | VARIANTA | 2.000 |
| | 70 | 64 | 9,6 | HD-20 | • | 62043 | 200 | VARIANTA | 2.000 |
| 6,0 | 80 | 74 | 9,6 | HD-20 | • | 62044 | 200 | VARIANTA | 2.000 |
| | 60 | 53 | 11,7 | HD-30 | • | 62045 | 200 | VARIANTA | 2.000 |
| | 80 | 73 | 11,7 | HD-30 | • | 62046 | 100 | VARIANTA | 1.000 |

* Alle schroeven met HECO-Drive zijn 100% compatibel met conventionele TX-bits.
Het GripFit-effect is alleen gegarandeerd bij gebruik met bijpassende HECO-Drive-bits.



Uitvoering: platverzonken kop met freesholtes

Aandrijving: HECO-Drive *

Draadtype: deeldraad

Materiaal: koolstofstaal

Oppervlakte: verzinkt blauw, A3K **CHROME (VI) FREE +**

Kleurcode op het HECO-etiket

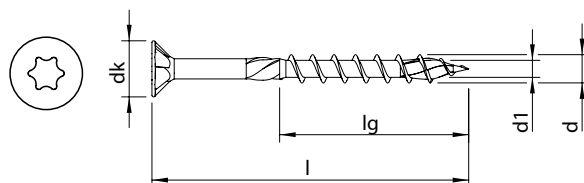

| Afmeting d x l [mm] | Draadlengte lg [mm] | Kopdiameter dk [mm] | Aandrijving | ETA | Artikelnummer | Aantal per verpakking [st.] | Type verpakking | Aantal per omverpakking [st.] |
|---------------------|---------------------|---------------------|-------------|--------------|--|-----------------------------|-----------------|-------------------------------|
| 3,0 ★ | 30 | 18 | 5,9 | T-10 | 60123 | 1.000 | VARIANTA | 10.000 |
| | 35 | 21 | 5,9 | T-10 | 60144 | 1.000 | VARIANTA | 10.000 |
| | 40 | 24 | 5,9 | T-10 | 60158 | 500 | VARIANTA | 5.000 |
| | 45 | 27 | 5,9 | T-10 | 60169 | 500 | VARIANTA | 5.000 |
| 3,5 ★ | 25 | 15 | 7,3 | HD-20 | 60236 | 1.000 | VARIANTA | 10.000 |
| | 30 | 18 | 7,3 | HD-20 | 60261 | 1.000 | VARIANTA | 10.000 |
| | 35 | 21 | 7,3 | HD-20 | 60284 | 1.000 | VARIANTA | 10.000 |
| | 40 | 24 | 7,3 | HD-20 | 60309 | 500 | VARIANTA | 5.000 |
| | 45 | 27 | 7,3 | HD-20 | 60326 | 500 | VARIANTA | 5.000 |
| | 50 | 30 | 7,3 | HD-20 | 60343 | 500 | VARIANTA | 5.000 |
| 4,0 ★ | 30 | 18 | 7,9 | HD-20 | 60434 | 1.000 | VARIANTA | 10.000 |
| | 35 | 21 | 7,9 | HD-20 | 60458 | 500 | VARIANTA | 5.000 |
| | 40 | 24 | 7,9 | HD-20 | 60485 | 500 | VARIANTA | 5.000 |
| | 45 | 27 | 7,9 | HD-20 | 60509 | 500 | VARIANTA | 5.000 |
| | 50 | 30 | 7,9 | HD-20 | 60534 | 500 | VARIANTA | 5.000 |
| | 55 | 33 | 7,9 | HD-20 | 60551 | 200 | VARIANTA | 2.000 |
| | 60 | 36 | 7,9 | HD-20 | 60560 | 200 | VARIANTA | 2.000 |
| 4,5 ★ | 30 | 18 | 8,9 | HD-20 | 60640 | 500 | VARIANTA | 5.000 |
| | 35 | 21 | 8,9 | HD-20 | 60661 | 500 | VARIANTA | 5.000 |
| | 40 | 24 | 8,9 | HD-20 | 62688 | NIEUW | SKV | 4.000 |
| | 40 | 24 | 8,9 | HD-20/T-25** | 60685 / 62245 ** | NIEUW | VARIANTA | 5.000 |
| | 45 | 27 | 8,9 | HD-20 | 62689 | NIEUW | SKV | 4.000 |
| | 45 | 27 | 8,9 | HD-20/T-25** | 60708 / 62246 ** | NIEUW | VARIANTA | 5.000 |
| | 50 | 30 | 8,9 | HD-20/T-25** | 60731 / 62247 ** | NIEUW | VARIANTA | 2.000 |
| | 60 | 36 | 8,9 | HD-20/T-25** | 60759 / 62248 ** | NIEUW | VARIANTA | 2.000 |
| | 70 | 42 | 8,9 | HD-20 | 62690 | NIEUW | VARIANTA | 1.000 |
| | 70 | 42 | 8,9 | HD-20/T-25** | 60776 / 62249 ** | NIEUW | VARIANTA | 2.000 |
| | 80 | 48 | 8,9 | HD-20/T-25** | 60786 / 62250 ** | NIEUW | VARIANTA | 2.000 |

* Alle schroeven met HECO-Drive zijn 100% compatibel met conventionele TX-bits.
Het GripFit-effect is alleen gegarandeerd bij gebruik met bijpassende HECO-Drive-bits.

** Alternatieve houtbouwvariant met aandrijving T-25 (zonder GripFit-effect)

Uitvoering: platverzonken kop met freesholtes

Aandrijving: HECO-Drive*

Draadtype: deeldraad

Materiaal: koolstofstaal

Oppervlakte: verzinkt blauw, A3K **CHROME (VI) FREE +**

Kleurcode op het HECO-etiket

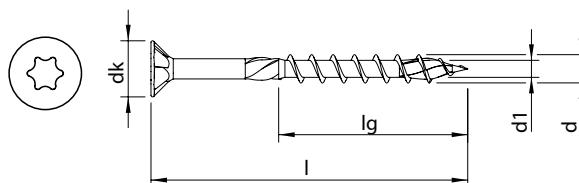

| Afmeting d x l [mm] | Draadlengte lg [mm] | Kopdiameter dk [mm] | Aandrijving | ETA | Artikelnummer | Aantal per verpakking [st.] | Type verpakking | Aantal per omverpakking [st.] | |
|---------------------|---------------------|---------------------|--------------|---------------|---------------|-----------------------------|-----------------|-------------------------------|-------|
| 5,0 | 30 | 18 | 9,6 | HD-20 | 60839 | 500 | VARIANTA | 5.000 | |
| | 35 | 21 | 9,6 | HD-20 | 60857 | 500 | VARIANTA | 5.000 | |
| | 40 | 24 | 9,6 | HD-20/T-25** | 60875/62251** | NIEUW | 500 | VARIANTA | 5.000 |
| | 45 | 27 | 9,6 | HD-20/T-25** | 60891/62252** | NIEUW | 200 | VARIANTA | 2.000 |
| | 50 | 30 | 9,6 | HD-20/T-25** | 60905/62253** | NIEUW | 200 | VARIANTA | 2.000 |
| | 60 | 36 | 9,6 | HD-20/T-25** | 60929/62254** | NIEUW | 200 | VARIANTA | 2.000 |
| | 70 | 42 | 9,6 | HD-20 | 62692 | NIEUW | 100 | VARIANTA | 1.000 |
| | 70 | 42 | 9,6 | HD-20/T-25** | 60945/62255** | NIEUW | 200 | VARIANTA | 2.000 |
| | 80 | 48 | 9,6 | HD-20 | 62693 | NIEUW | 100 | VARIANTA | 1.000 |
| | 80 | 48 | 9,6 | HD-20/T-25** | 60957/62256** | NIEUW | 200 | VARIANTA | 2.000 |
| | 90 | 54 | 9,6 | HD-20 | 62694 | NIEUW | 100 | VARIANTA | 1.000 |
| | 90 | 54 | 9,6 | HD-20/T-25** | 60967/62257** | NIEUW | 200 | VARIANTA | 2.000 |
| | 100 | 60 | 9,6 | HD-20/T-25** | 60978/62258** | NIEUW | 100 | VARIANTA | 1.000 |
| 120 | 60 | 9,6 | HD-20/T-25** | 60988/62259** | NIEUW | 100 | VARIANTA | 1.000 | |
| 6,0 | 50 | 30 | 11,7 | HD-30 | 61033 | 200 | VARIANTA | 2.000 | |
| | 60 | 36 | 11,7 | HD-30/T-25** | 61056/62260** | NIEUW | 200 | VARIANTA | 2.000 |
| | 70 | 42 | 11,7 | HD-30/T-25** | 61076/62261** | NIEUW | 200 | VARIANTA | 1.000 |
| | 80 | 48 | 11,7 | HD-30/T-25** | 61088/62262** | NIEUW | 100 | VARIANTA | 1.000 |
| | 90 | 54 | 11,7 | HD-30/T-25** | 61102/62263** | NIEUW | 100 | VARIANTA | 1.000 |
| | 100 | 60 | 11,7 | HD-30/T-25** | 61111/62264** | NIEUW | 100 | VARIANTA | 1.000 |
| | 110 | 66 | 11,7 | HD-30/T-25** | 61124/62265** | NIEUW | 100 | VARIANTA | 1.000 |
| | 120 | 72 | 11,7 | HD-30/T-25** | 61132/62266** | NIEUW | 100 | VARIANTA | 1.000 |
| | 130 | 72 | 11,7 | HD-30/T-25** | 61142/62267** | NIEUW | 100 | VARIANTA | 1.000 |
| | 140 | 72 | 11,7 | HD-30/T-25** | 61147/62268** | NIEUW | 100 | VARIANTA | 500 |
| | 150 | 72 | 11,7 | HD-30/T-25** | 61156/62269** | NIEUW | 100 | VARIANTA | 800 |
| | 160 | 72 | 11,7 | HD-30/T-25** | 61163/62270** | NIEUW | 100 | VARIANTA | 800 |
| | 180 | 72 | 11,7 | HD-30/T-25** | 61172/62271** | NIEUW | 100 | VARIANTA | 400 |
| | 200 | 72 | 11,7 | HD-30/T-25** | 61180/62272** | NIEUW | 100 | VARIANTA | 400 |
| | 220 | 72 | 11,7 | HD-30/T-25** | 61187/62273** | NIEUW | 100 | VARIANTA | 400 |
| | 240 | 72 | 11,7 | HD-30/T-25** | 61195/62274** | NIEUW | 100 | VARIANTA | 400 |
| | 260 | 72 | 11,7 | HD-30/T-25** | 61202/62275** | NIEUW | 100 | VARIANTA | 400 |
| 280 | 72 | 11,7 | HD-30/T-25** | 61209/62276** | NIEUW | 100 | VARIANTA | 400 | |
| 300 | 72 | 11,7 | HD-30/T-25** | 61217/62277** | NIEUW | 100 | VARIANTA | 400 | |

* Alle schroeven met HECO-Drive zijn 100% compatibel met conventionele TX-bits.
Het GripFit-effect is alleen gegarandeerd bij gebruik met bijpassende HECO-Drive-bits.

** Alternatieve houtbouwvariant met aandrijving T-25 (zonder GripFit-effect)



Uitvoering: platverzonken kop met freesholtes

Aandrijving: HECO-Drive *

Draadtype: deeldraad

Materiaal: koolstofstaal

Oppervlakte: verzinkt blauw, A3K **CHROME (VI) FREE +**

Kleurcode op het HECO-etiket

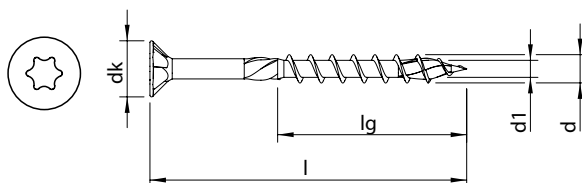

| Afmeting d x l [mm] | Draadlengte lg [mm] | Kopdiameter dk [mm] | Aandrijving | ETA | Artikelnummer | Aantal per verpakking [st.] | Type verpakking | Aantal per omverpakking [st.] | |
|---------------------|---------------------|---------------------|-------------|-------|-----------------------|-----------------------------|-----------------|-------------------------------|-----|
| 8,0 ★ | 80 | 60 | 14,8 | HD-40 | ● | 61242 | 100 | VARIANTA | 400 |
| | 90 | 60 | 14,8 | HD-40 | ● | 61251 | 100 | VARIANTA | 400 |
| | 100 | 60 | 14,8 | HD-40 | ● | 61257 | 100 | VARIANTA | 400 |
| | 120 | 72 | 14,8 | HD-40 | ● | 61268 | 100 | VARIANTA | 400 |
| | 140 | 72 | 14,8 | HD-40 | ● | 61277 | 100 | VARIANTA | 400 |
| | 160 | 100 | 14,8 | HD-40 | ● | 61291 | 100 | VARIANTA | 400 |
| | 180 | 100 | 14,8 | HD-40 | ● | 61303 | 100 | VARIANTA | 200 |
| | 200 | 100 | 14,8 | HD-40 | ● | 61315 | 100 | VARIANTA | 200 |
| | 220 | 100 | 14,8 | HD-40 | ● | 61327 | 50 | VARIANTA | 200 |
| | 240 | 100 | 14,8 | HD-40 | ● | 61338 | 50 | VARIANTA | 200 |
| | 260 | 100 | 14,8 | HD-40 | ● | 61349 | 50 | VARIANTA | 200 |
| | 280 | 100 | 14,8 | HD-40 | ● | 61362 | 50 | VARIANTA | 200 |
| | 300 | 100 | 14,8 | HD-40 | ● | 61375 | 50 | VARIANTA | 200 |
| | 320 | 100 | 14,8 | HD-40 | ● | 61385 | 50 | VARIANTA | 200 |
| | 340 | 100 | 14,8 | HD-40 | ● | 61397 | 50 | VARIANTA | 200 |
| | 360 | 100 | 14,8 | HD-40 | ● | 61409 | 50 | VARIANTA | 100 |
| | 380 | 100 | 14,8 | HD-40 | ● | 61419 | 50 | VARIANTA | 100 |
| | 400 | 100 | 14,8 | HD-40 | ● | 61428 | 50 | VARIANTA | 100 |
| | 420 | 100 | 14,8 | HD-40 | ● | 61435 | 50 | VARIANTA | 100 |
| 460 | 100 | 14,8 | HD-40 | ● | 61440 | 50 | VARIANTA | 100 | |
| 500 | 100 | 14,8 | HD-40 | ● | 61445 | 50 | VARIANTA | 100 | |

* Alle schroeven met HECO-Drive zijn 100% compatibel met conventionele TX-bits.
Het GripFit-effect is alleen gegarandeerd bij gebruik met bijpassende HECO-Drive-bits.

Bijpassende onderlegschijven vindt u op pagina 176, een inschroefhulp voor inschroef hoek 60° en 45° op pagina 177

Uitvoering: platverzonken kop met freesholtes

Aandrijving: HECO-Drive *

Draadtype: deeldraad

Materiaal: koolstofstaal

Oppervlakte: verzinkt blauw, A3K **CHROME (VI) FREE +**

Kleurcode op het HECO-etiket

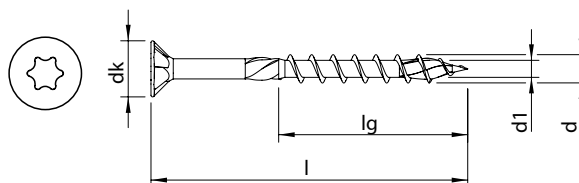

| Afmeting d x l [mm] | Draadlengte lg [mm] | Kopdiameter dk [mm] | Aandrijving | ETA | Artikelnummer | Aantal per verpakking [st.] | Type verpakking | Aantal per omverpakking [st.] | |
|---------------------|---------------------|---------------------|-------------|-------|-----------------------|-----------------------------|-----------------|-------------------------------|-----|
| 10,0 | 80 | 60 | 18,5 | HD-40 | ● | 61473 | 50 | VARIANTA | 200 |
| | 100 | 84 | 18,5 | HD-40 | ● | 61481 | 50 | VARIANTA | 200 |
| | 120 | 84 | 18,5 | HD-40 | ● | 61490 | 50 | VARIANTA | 200 |
| | 140 | 84 | 18,5 | HD-40 | ● | 61499 | 50 | VARIANTA | 200 |
| | 160 | 100 | 18,5 | HD-40 | ● | 61508 | 50 | VARIANTA | 200 |
| | 180 | 100 | 18,5 | HD-40 | ● | 61516 | 50 | VARIANTA | 200 |
| | 200 | 100 | 18,5 | HD-40 | ● | 61524 | 50 | VARIANTA | 200 |
| | 220 | 100 | 18,5 | HD-40 | ● | 61533 | 50 | VARIANTA | 200 |
| | 240 | 100 | 18,5 | HD-40 | ● | 61541 | 50 | VARIANTA | 100 |
| | 260 | 100 | 18,5 | HD-40 | ● | 61549 | 50 | VARIANTA | 100 |
| | 280 | 100 | 18,5 | HD-40 | ● | 61559 | 50 | VARIANTA | 100 |
| | 300 | 100 | 18,5 | HD-40 | ● | 61569 | 50 | VARIANTA | 100 |
| | 320 | 100 | 18,5 | HD-40 | ● | 61577 | 50 | VARIANTA | 100 |
| | 340 | 100 | 18,5 | HD-40 | ● | 61586 | 50 | VARIANTA | 100 |
| | 360 | 100 | 18,5 | HD-40 | ● | 61590 | 50 | VARIANTA | 100 |
| | 380 | 100 | 18,5 | HD-40 | ● | 61597 | 50 | VARIANTA | 100 |
| | 400 | 100 | 18,5 | HD-40 | ● | 61600 | 50 | VARIANTA | 100 |
| 420 | 100 | 18,5 | HD-40 | ● | 61607 | 25 | VARIANTA | 100 | |
| 460 | 100 | 18,5 | HD-40 | ● | 61611 | 25 | VARIANTA | 100 | |
| 500 | 100 | 18,5 | HD-40 | ● | 61614 | 25 | VARIANTA | 50 | |

* Alle schroeven met HECO-Drive zijn 100% compatibel met conventionele TX-bits.
Het GripFit-effect is alleen gegarandeerd bij gebruik met passende HECO-Drive-bits.

Bijpassende onderlegschijven vindt u op pagina 176, een inschroefhulp voor inschroef hoek 60° en 45° op pagina 177



Uitvoering: platverzonken kop met freesholtes

Aandrijving: HECO-Drive *

Draadtype: deeldraad

Materiaal: koolstofstaal

Oppervlakte: verzinkt geel, A3L **CHROME (VI) FREE +**

Kleurcode op het HECO-etiket

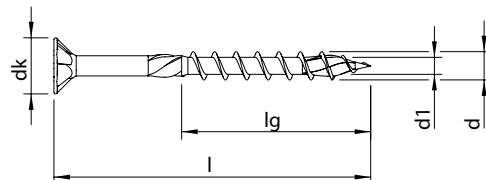

| Afmeting d x l [mm] | Draadlengte lg [mm] | Kopdiameter dk [mm] | Aandrijving | ETA | Artikelnummer | Aantal per verpakking [st.] | Type verpakking | Aantal per omverpakking [st.] | |
|---------------------|---------------------|---------------------|-------------|-------|-----------------------|-----------------------------|-----------------|-------------------------------|--------|
| 3,5 ★ | 25 | 15 | 7,3 | HD-20 | ● | 60238 | 1.000 | VARIANTA | 10.000 |
| | 30 | 18 | 7,3 | HD-20 | ● | 60262 | 1.000 | VARIANTA | 10.000 |
| | 35 | 21 | 7,3 | HD-20 | ● | 60286 | 1.000 | VARIANTA | 10.000 |
| | 40 | 24 | 7,3 | HD-20 | ● | 60310 | 500 | VARIANTA | 5.000 |
| | 45 | 27 | 7,3 | HD-20 | ● | 60327 | 500 | VARIANTA | 5.000 |
| | 50 | 30 | 7,3 | HD-20 | ● | 60344 | 500 | VARIANTA | 5.000 |
| 4,0 ★ | 30 | 18 | 7,9 | HD-20 | ● | 60436 | 1.000 | VARIANTA | 10.000 |
| | 35 | 21 | 7,9 | HD-20 | ● | 60460 | 500 | VARIANTA | 5.000 |
| | 40 | 24 | 7,9 | HD-20 | ● | 60488 | 500 | VARIANTA | 5.000 |
| | 45 | 27 | 7,9 | HD-20 | ● | 60511 | 500 | VARIANTA | 5.000 |
| | 50 | 30 | 7,9 | HD-20 | ● | 60537 | 500 | VARIANTA | 5.000 |
| | 60 | 36 | 7,9 | HD-20 | ● | 60562 | 200 | VARIANTA | 2.000 |
| 4,5 ★ | 70 | 42 | 7,9 | HD-20 | ● | 60576 | 200 | VARIANTA | 2.000 |
| | 30 | 18 | 8,9 | HD-20 | ● | 60641 | 500 | VARIANTA | 5.000 |
| | 35 | 21 | 8,9 | HD-20 | ● | 60662 | 500 | VARIANTA | 5.000 |
| | 40 | 24 | 8,9 | HD-20 | ● | 60686 | 500 | VARIANTA | 5.000 |
| | 45 | 27 | 8,9 | HD-20 | ● | 60709 | 500 | VARIANTA | 5.000 |
| | 50 | 30 | 8,9 | HD-20 | ● | 60733 | 200 | VARIANTA | 2.000 |
| | 60 | 36 | 8,9 | HD-20 | ● | 60761 | 200 | VARIANTA | 2.000 |
| | 70 | 42 | 8,9 | HD-20 | ● | 60778 | 200 | VARIANTA | 2.000 |
| 80 | 48 | 8,9 | HD-20 | ● | 60788 | 200 | VARIANTA | 2.000 | |

* Alle schroeven met HECO-Drive zijn 100% compatibel met conventionele TX-bits.
Het GripFit-effect is alleen gegarandeerd bij gebruik met bijpassende HECO-Drive-bits.

Uitvoering: platverzonken kop met freesholtes

Aandrijving: HECO-Drive *

Draadtype: deeldraad

Materiaal: koolstofstaal

Oppervlakte: verzinkt geel, A3L **CHROME (VI) FREE +**

Kleurcode op het HECO-etiket

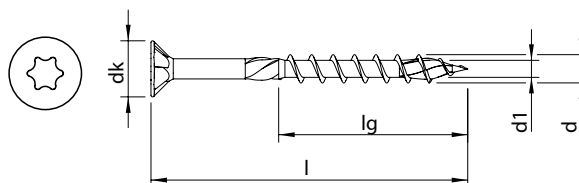

| Afmeting d x l [mm] | Draadlengte lg [mm] | Kopdiameter dk [mm] | Aandrijving | ETA | Artikelnummer | Aantal per verpakking [st.] | Type verpakking | Aantal per omverpakking [st.] |
|---------------------|---------------------|---------------------|-------------|-----------------------|-----------------------|-----------------------------|-----------------|-------------------------------|
| 5,0 | 30 | 18 | 9,6 | HD-20 | 60840 | 500 | VARIANTA | 5.000 |
| | 35 | 21 | 9,6 | HD-20 | 60858 | 500 | VARIANTA | 5.000 |
| | 40 | 24 | 9,6 | HD-20 | 60877 | 500 | VARIANTA | 2.500 |
| | 45 | 27 | 9,6 | HD-20 | 60892 | 200 | VARIANTA | 2.000 |
| | 50 | 30 | 9,6 | HD-20 | 60907 | 200 | VARIANTA | 2.000 |
| | 60 | 36 | 9,6 | HD-20 | 60931 | 200 | VARIANTA | 2.000 |
| | 70 | 42 | 9,6 | HD-20 | 60947 | 200 | VARIANTA | 2.000 |
| | 80 | 48 | 9,6 | HD-20 | 60959 | 200 | VARIANTA | 2.000 |
| | 90 | 54 | 9,6 | HD-20 | 60969 | 200 | VARIANTA | 2.000 |
| | 100 | 60 | 9,6 | HD-20 | 60980 | 100 | VARIANTA | 1.000 |
| | 120 | 60 | 9,6 | HD-20 | 60990 | 100 | VARIANTA | 1.000 |
| 6,0 | 50 | 30 | 11,7 | HD-30 | 61034 | 200 | VARIANTA | 2.000 |
| | 60 | 36 | 11,7 | HD-30 | 61058 | 200 | VARIANTA | 2.000 |
| | 70 | 42 | 11,7 | HD-30 | 61078 | 200 | VARIANTA | 1.000 |
| | 80 | 48 | 11,7 | HD-30 | 61090 | 100 | VARIANTA | 1.000 |
| | 90 | 54 | 11,7 | HD-30 | 61104 | 100 | VARIANTA | 1.000 |
| | 100 | 60 | 11,7 | HD-30 | 61113 | 100 | VARIANTA | 1.000 |
| | 110 | 66 | 11,7 | HD-30 | 61126 | 100 | VARIANTA | 1.000 |
| 120 | 72 | 11,7 | HD-30 | 61134 | 100 | VARIANTA | 1.000 | |

* Alle schroeven met HECO-Drive zijn 100% compatibel met conventionele TX-bits.
Het GripFit-effect is alleen gegarandeerd bij gebruik met bijpassende HECO-Drive-bits.



Uitvoering: platverzonken kop met freesholtes

Aandrijving: HECO-Drive *

Draadtype: deeldraad

Materiaal: roestvaststaal A2 1.4567

Oppervlakte: blank, glijcoating

Kleurcode op het HECO-etiket

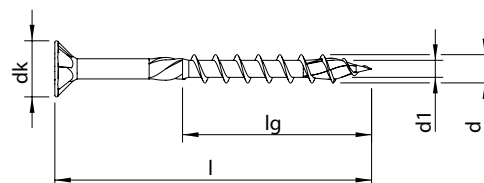

| Afmeting d x l [mm] | Draadlengte lg [mm] | Kopdiameter dk [mm] | Aandrijving | ETA | Artikelnummer | Aantal per verpakking [st.] | Type verpakking | Aantal per omverpakking [st.] | |
|---------------------|---------------------|---------------------|-------------|-------|-----------------------|-----------------------------|-----------------|-------------------------------|-------|
| 3,5 ★ | 30 | 18 | 7,3 | HD-20 | ● | 61637 | 200 | SKV | 4.800 |
| | 35 | 21 | 7,3 | HD-20 | ● | 61642 | 200 | SKV | 4.000 |
| | 40 | 24 | 7,3 | HD-20 | ● | 61647 | 200 | SKV | 4.000 |
| | 45 | 27 | 7,3 | HD-20 | ● | 61650 | 200 | SKV | 4.000 |
| | 50 | 30 | 7,3 | HD-20 | ● | 61653 | 200 | SKV | 4.000 |
| 4,0 ★ | 25 | 15 | 7,9 | HD-20 | ● | 61662 | 200 | SKV | 4.800 |
| | 30 | 18 | 7,9 | HD-20 | ● | 61667 | 200 | SKV | 4.800 |
| | 35 | 21 | 7,9 | HD-20 | ● | 61672 | 200 | SKV | 4.000 |
| | 40 | 24 | 7,9 | HD-20 | ● | 61677 | 200 | SKV | 4.000 |
| | 45 | 27 | 7,9 | HD-20 | ● | 61681 | 200 | SKV | 4.000 |
| | 50 | 30 | 7,9 | HD-20 | ● | 61685 | 200 | SKV | 4.000 |
| | 60 | 36 | 7,9 | HD-20 | ● | 61689 | 200 | VARIANTA | 2.000 |
| 4,5 ★ | 70 | 42 | 7,9 | HD-20 | ● | 61690 | 200 | VARIANTA | 2.000 |
| | 30 | 18 | 8,9 | HD-20 | ● | 61694 | 200 | SKV | 4.000 |
| | 35 | 21 | 8,9 | HD-20 | ● | 61696 | 200 | SKV | 4.000 |
| | 40 | 24 | 8,9 | HD-20 | ● | 61699 | 200 | SKV | 4.000 |
| | 45 | 27 | 8,9 | HD-20 | ● | 61703 | 200 | SKV | 4.000 |
| | 50 | 30 | 8,9 | HD-20 | ● | 61709 | 200 | VARIANTA | 2.000 |
| | 60 | 36 | 8,9 | HD-20 | ● | 61714 | 200 | VARIANTA | 2.000 |
| | 70 | 42 | 8,9 | HD-20 | ● | 61718 | 200 | VARIANTA | 2.000 |
| 5,0 ★ | 80 | 48 | 8,9 | HD-20 | ● | 61722 | 200 | VARIANTA | 2.000 |
| | 30 | 18 | 9,6 | HD-20 | ● | 61731 | 200 | SKV | 4.000 |
| | 35 | 21 | 9,6 | HD-20 | ● | 61736 | 200 | SKV | 4.000 |
| | 40 | 24 | 9,6 | HD-20 | ● | 61746 | 200 | SKV | 4.000 |
| | 45 | 27 | 9,6 | HD-20 | ● | 61752 | 200 | VARIANTA | 2.000 |
| | 50 | 30 | 9,6 | HD-20 | ● | 61762 | 200 | VARIANTA | 2.000 |
| | 60 | 36 | 9,6 | HD-20 | ● | 61775 | 200 | VARIANTA | 2.000 |
| | 70 | 42 | 9,6 | HD-20 | ● | 61786 | 200 | VARIANTA | 2.000 |
| | 80 | 48 | 9,6 | HD-20 | ● | 61796 | 200 | VARIANTA | 2.000 |
| | 90 | 54 | 9,6 | HD-20 | ● | 61797 | 200 | VARIANTA | 2.000 |
| 100 | 60 | 9,6 | HD-20 | ● | 61798 | 100 | VARIANTA | 1.000 | |

* Alle schroeven met HECO-Drive zijn 100% compatibel met conventionele TX-bits.
Het GripFit-effect is alleen gegarandeerd bij gebruik met bijpassende HECO-Drive-bits.

Uitvoering: platverzonken kop met freesholtes

Aandrijving: HECO-Drive*

Draadtype: deeldraad

Materiaal: roestvaststaal A2 1.4567

Oppervlakte: blank, glijcoating

Kleurcode op het HECO-etiket

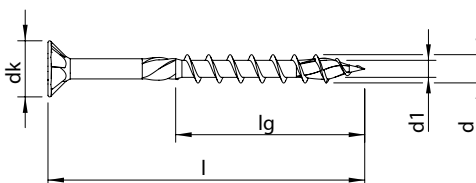

| Afmeting d x l [mm] | Draadlengte lg [mm] | Kopdiameter dk [mm] | Aandrijving | ETA | Artikelnummer | Aantal per verpakking [st.] | Type verpakking | Aantal per omverpakking [st.] | |
|---------------------|---------------------|---------------------|-------------|-------|---------------|-----------------------------|-----------------|-------------------------------|-------|
| 6,0 ★ | 40 | 24 | 11,7 | HD-30 | ● | 61801 | 200 | VARIANTA | 2.000 |
| | 50 | 30 | 11,7 | HD-30 | ● | 61804 | 200 | VARIANTA | 2.000 |
| | 60 | 36 | 11,7 | HD-30 | ● | 61808 | 200 | VARIANTA | 2.000 |
| | 70 | 42 | 11,7 | HD-30 | ● | 61813 | 200 | VARIANTA | 1.000 |
| | 80 | 48 | 11,7 | HD-30 | ● | 61818 | 100 | VARIANTA | 1.000 |
| | 90 | 54 | 11,7 | HD-30 | ● | 61822 | 100 | VARIANTA | 1.000 |
| | 100 | 60 | 11,7 | HD-30 | ● | 61826 | 100 | VARIANTA | 1.000 |
| | 120 | 72 | 11,7 | HD-30 | ● | 61833 | 100 | VARIANTA | 1.000 |
| | 140 | 72 | 11,7 | HD-30 | ● | 61838 | 100 | VARIANTA | 500 |
| | 160 | 72 | 11,7 | HD-30 | ● | 61840 | 100 | VARIANTA | 400 |
| | 180 | 72 | 11,7 | HD-30 | ● | 61842 | 100 | VARIANTA | 400 |
| | 200 | 72 | 11,7 | HD-30 | ● | 61843 | 100 | VARIANTA | 400 |
| 8,0 ★ | 80 | 60 | 14,8 | HD-40 | ● | 61847 | 100 | VARIANTA | 400 |
| | 100 | 60 | 14,8 | HD-40 | ● | 61851 | 100 | VARIANTA | 400 |
| | 120 | 72 | 14,8 | HD-40 | ● | 61857 | 100 | VARIANTA | 400 |
| | 140 | 72 | 14,8 | HD-40 | ● | 61862 | 100 | VARIANTA | 400 |
| | 160 | 100 | 14,8 | HD-40 | ● | 61866 | 100 | VARIANTA | 400 |
| | 180 | 100 | 14,8 | HD-40 | ● | 61870 | 100 | VARIANTA | 200 |
| | 200 | 100 | 14,8 | HD-40 | ● | 61874 | 100 | VARIANTA | 200 |
| | 220 | 100 | 14,8 | HD-40 | ● | 61879 | 50 | VARIANTA | 200 |
| | 240 | 100 | 14,8 | HD-40 | ● | 61885 | 50 | VARIANTA | 200 |
| | 260 | 100 | 14,8 | HD-40 | ● | 61889 | 50 | VARIANTA | 200 |
| | 280 | 100 | 14,8 | HD-40 | ● | 61894 | 50 | VARIANTA | 200 |
| | 300 | 100 | 14,8 | HD-40 | ● | 61900 | 50 | VARIANTA | 200 |
| | 320 | 100 | 14,8 | HD-40 | ● | 61904 | 50 | VARIANTA | 200 |
| | 340 | 100 | 14,8 | HD-40 | ● | 61905 | 50 | VARIANTA | 200 |
| | 360 | 100 | 14,8 | HD-40 | ● | 61908 | 50 | VARIANTA | 100 |
| | 380 | 100 | 14,8 | HD-40 | ● | 61909 | 50 | VARIANTA | 100 |
| | 400 | 100 | 14,8 | HD-40 | ● | 61910 | 50 | VARIANTA | 100 |

* Alle schroeven met HECO-Drive zijn 100% compatibel met conventionele TX-bits.
Het GripFit-effect is alleen gegarandeerd bij gebruik met bijpassende HECO-Drive-bits.



Uitvoering: platverzonken kop met freesholtes

Aandrijving: Pozi-Drive

Draadtype: variabele voldraad

Materiaal: koolstofstaal

Oppervlakte: verzinkt blauw, A3K **CHROME (VI) FREE +**

Kleurcode op het HECO-etiket

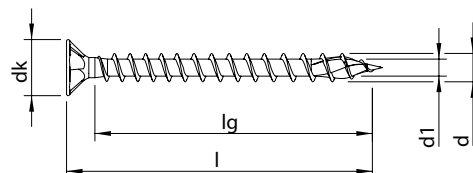

| Afmeting d x l [mm] | Draadlengte lg [mm] | Kopdiameter dk [mm] | Aandrijving | ETA | Artikelnummer | Aantal per verpakking [st.] | Type verpakking | Aantal per omverpakking [st.] |
|---------------------|---------------------|---------------------|-------------|-----------------------|-----------------------|-----------------------------|-----------------|-------------------------------|
| 2,5 + | 10 | 7 | 4,9 | PZD-1 | 60001 | 200 | SKV | 4.800 |
| | 10 | 7 | 4,9 | PZD-1 | 60002 | 1.000 | VARIANTA | 10.000 |
| | 12 | 9 | 4,9 | PZD-1 | 60005 | 200 | SKV | 4.800 |
| | 12 | 9 | 4,9 | PZD-1 | 60006 | 1.000 | VARIANTA | 10.000 |
| | 16 | 13 | 4,9 | PZD-1 | 60015 | 200 | SKV | 4.800 |
| | 16 | 13 | 4,9 | PZD-1 | 60016 | 1.000 | VARIANTA | 10.000 |
| | 20 | 17 | 4,9 | PZD-1 | 60022 | 200 | SKV | 4.800 |
| | 20 | 17 | 4,9 | PZD-1 | 60023 | 1.000 | VARIANTA | 10.000 |
| | 25 | 22 | 4,9 | PZD-1 | 60026 | 200 | SKV | 4.800 |
| 3,0 + | 25 | 22 | 4,9 | PZD-1 | 60027 | 1.000 | VARIANTA | 10.000 |
| | 10 | 6 | 5,9 | PZD-1 | 60030 | 200 | SKV | 4.800 |
| | 10 | 6 | 5,9 | PZD-1 | 60031 | 1.000 | VARIANTA | 10.000 |
| | 12 | 8 | 5,9 | PZD-1 | 60035 | 200 | SKV | 4.800 |
| | 12 | 8 | 5,9 | PZD-1 | 60036 | 1.000 | VARIANTA | 10.000 |
| | 15 | 11 | 5,9 | PZD-1 | 60050 | 200 | SKV | 4.800 |
| | 15 | 11 | 5,9 | PZD-1 | 60051 | 1.000 | VARIANTA | 10.000 |
| | 16 | 12 | 5,9 | PZD-1 | 60057 | 200 | SKV | 4.800 |
| | 16 | 12 | 5,9 | PZD-1 | 60058 | 1.000 | VARIANTA | 10.000 |
| | 20 | 16 | 5,9 | PZD-1 | 60077 | 200 | SKV | 4.800 |
| | 20 | 16 | 5,9 | PZD-1 | 60078 | 1.000 | VARIANTA | 10.000 |
| | 25 | 21 | 5,9 | PZD-1 | 60095 | 200 | SKV | 4.800 |
| | 25 | 21 | 5,9 | PZD-1 | 60096 | 1.000 | VARIANTA | 10.000 |
| | 30 | 26 | 5,9 | PZD-1 | 60112 | 200 | SKV | 4.800 |
| | 30 | 26 | 5,9 | PZD-1 | 60113 | 1.000 | VARIANTA | 10.000 |
| | 35 | 31 | 5,9 | PZD-1 | 60134 | 200 | SKV | 4.800 |
| | 35 | 31 | 5,9 | PZD-1 | 60135 | 1.000 | VARIANTA | 10.000 |
| | 40 | 36 | 5,9 | PZD-1 | 60147 | 200 | SKV | 4.000 |
| | 40 | 36 | 5,9 | PZD-1 | 60148 | 500 | VARIANTA | 5.000 |
| 45 | 41 | 5,9 | PZD-1 | 60160 | 500 | VARIANTA | 5.000 | |

Uitvoering: platverzonken kop met freesholtes

Aandrijving: Pozi-Drive

Draadtype: variabele voldraad

Materiaal: koolstofstaal

Oppervlakte: verzinkt blauw, A3K **CHROME (VI) FREE +**

Kleurcode op het HECO-etiket

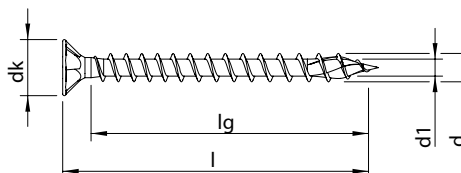
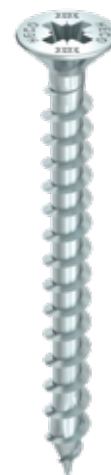

| Afmeting d x l [mm] | Draadlengte lg [mm] | Kopdiameter dk [mm] | Aandrijving | ETA | Artikelnummer | Aantal per verpakking [st.] | Type verpakking | Aantal per omverpakking [st.] |
|---------------------|---------------------|---------------------|-------------|-------------------------|-------------------------|-----------------------------|-----------------|-------------------------------|
| 3,5 | 12 | 7 | 7,3 | PZD-2 | 60171 | 200 | SKV | 4.800 |
| | 12 | 7 | 7,3 | PZD-2 | 60172 | 1.000 | VARIANTA | 10.000 |
| | 15 | 10 | 7,3 | PZD-2 | 60183 | 200 | SKV | 4.800 |
| | 15 | 10 | 7,3 | PZD-2 | 60184 | 1.000 | VARIANTA | 10.000 |
| | 16 | 11 | 7,3 | PZD-2 | 60190 | 200 | SKV | 4.800 |
| | 16 | 11 | 7,3 | PZD-2 | 60191 | 1.000 | VARIANTA | 10.000 |
| | 20 | 15 | 7,3 | PZD-2 | • 60209 | 200 | SKV | 4.800 |
| | 20 | 15 | 7,3 | PZD-2 | • 60210 | 1.000 | VARIANTA | 10.000 |
| | 25 | 20 | 7,3 | PZD-2 | • 60226 | 200 | SKV | 4.800 |
| | 25 | 20 | 7,3 | PZD-2 | • 60227 | 1.000 | VARIANTA | 10.000 |
| | 30 | 25 | 7,3 | PZD-2 | • 60251 | 200 | SKV | 4.800 |
| | 30 | 25 | 7,3 | PZD-2 | • 60252 | 1.000 | VARIANTA | 10.000 |
| | 35 | 30 | 7,3 | PZD-2 | • 60274 | 200 | SKV | 4.000 |
| | 35 | 30 | 7,3 | PZD-2 | • 60275 | 1.000 | VARIANTA | 10.000 |
| | 40 | 35 | 7,3 | PZD-2 | • 60298 | 200 | SKV | 4.000 |
| | 40 | 35 | 7,3 | PZD-2 | • 60299 | 500 | VARIANTA | 5.000 |
| | 45 | 40 | 7,3 | PZD-2 | • 60316 | 200 | SKV | 4.000 |
| | 45 | 40 | 7,3 | PZD-2 | • 60317 | 500 | VARIANTA | 5.000 |
| | 50 | 45 | 7,3 | PZD-2 | • 60332 | 200 | SKV | 4.000 |
| 50 | 45 | 7,3 | PZD-2 | • 60333 | 500 | VARIANTA | 5.000 | |



Uitvoering: platverzonken kop met freesholtes

Aandrijving: Pozi-Drive

Draadtype: variabele voldraad

Materiaal: koolstofstaal

Oppervlakte: verzinkt blauw, A3K **CHROME (VI) FREE +**

Kleurcode op het HECO-etiket

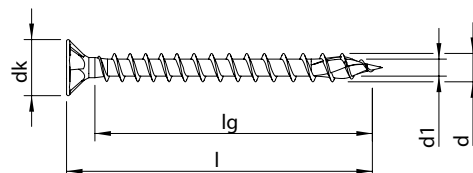

| Afmeting d x l [mm] | Draadlengte lg [mm] | Kopdiameter dk [mm] | Aandrijving | ETA | Artikelnummer | Aantal per verpakking [st.] | Type verpakking | Aantal per omverpakking [st.] |
|---------------------|---------------------|---------------------|-------------|-------------------------|-------------------------|-----------------------------|-----------------|-------------------------------|
| 4,0 | 12 | 7 | 7,9 | PZD-2 | 60350 | 200 | SKV | 4.800 |
| | 12 | 7 | 7,9 | PZD-2 | 60351 | 1.000 | VARIANTA | 10.000 |
| | 15 | 10 | 7,9 | PZD-2 | 60361 | 200 | SKV | 4.800 |
| | 15 | 10 | 7,9 | PZD-2 | 60362 | 1.000 | VARIANTA | 10.000 |
| | 16 | 11 | 7,9 | PZD-2 | 60368 | 200 | SKV | 4.800 |
| | 16 | 11 | 7,9 | PZD-2 | 60369 | 1.000 | VARIANTA | 10.000 |
| | 20 | 15 | 7,9 | PZD-2 | 60384 | 200 | SKV | 4.800 |
| | 20 | 15 | 7,9 | PZD-2 | 60385 | 1.000 | VARIANTA | 10.000 |
| | 25 | 20 | 7,9 | PZD-2 | • 60400 | 200 | SKV | 4.800 |
| | 25 | 20 | 7,9 | PZD-2 | • 60401 | 1.000 | VARIANTA | 10.000 |
| | 30 | 25 | 7,9 | PZD-2 | • 60424 | 200 | SKV | 4.800 |
| | 30 | 25 | 7,9 | PZD-2 | • 60425 | 1.000 | VARIANTA | 10.000 |
| | 35 | 30 | 7,9 | PZD-2 | • 60448 | 200 | SKV | 4.000 |
| | 35 | 30 | 7,9 | PZD-2 | • 60449 | 500 | VARIANTA | 5.000 |
| | 40 | 35 | 7,9 | PZD-2 | • 60469 | 200 | SKV | 4.000 |
| | 40 | 35 | 7,9 | PZD-2 | • 60471 | 500 | VARIANTA | 5.000 |
| | 40 | 35 | 7,9 | PZD-2 | • 60472 | 1.000 | VARIANTA | 10.000 |
| | 45 | 40 | 7,9 | PZD-2 | • 60497 | 200 | SKV | 4.000 |
| | 45 | 40 | 7,9 | PZD-2 | • 60498 | 500 | VARIANTA | 5.000 |
| | 50 | 45 | 7,9 | PZD-2 | • 60520 | 200 | SKV | 4.000 |
| 50 | 45 | 7,9 | PZD-2 | • 60521 | 500 | VARIANTA | 5.000 | |
| 55 | 50 | 7,9 | PZD-2 | • 60545 | 200 | VARIANTA | 2.000 | |
| 60 | 55 | 7,9 | PZD-2 | • 60554 | 200 | VARIANTA | 2.000 | |
| 70 | 65 | 7,9 | PZD-2 | • 60567 | 200 | VARIANTA | 2.000 | |

Uitvoering: platverzonken kop met freesholtes

Aandrijving: Pozi-Drive

Draadtype: variabele voldraad

Materiaal: koolstofstaal

Oppervlakte: verzinkt blauw, A3K **CHROME (VI) FREE +**

Kleurcode op het HECO-etiket

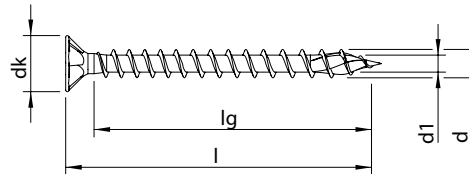

| Afmeting d x l [mm] | Draadlengte lg [mm] | Kopdiameter dk [mm] | Aandrijving | ETA | Artikelnummer | Aantal per verpakking [st.] | Type verpakking | Aantal per omverpakking [st.] |
|---------------------|---------------------|---------------------|-------------|-------------------------|-------------------------|-----------------------------|-----------------|-------------------------------|
| 4,5 | 16 | 11 | 8,9 | PZD-2 | 60581 | 200 | SKV | 4.800 |
| | 16 | 11 | 8,9 | PZD-2 | 60582 | 1.000 | VARIANTA | 10.000 |
| | 20 | 15 | 8,9 | PZD-2 | 60593 | 200 | SKV | 4.800 |
| | 20 | 15 | 8,9 | PZD-2 | 60594 | 1.000 | VARIANTA | 10.000 |
| | 25 | 20 | 8,9 | PZD-2 | • 60611 | 200 | SKV | 4.800 |
| | 25 | 20 | 8,9 | PZD-2 | • 60612 | 500 | VARIANTA | 5.000 |
| | 30 | 25 | 8,9 | PZD-2 | • 60629 | 200 | SKV | 4.000 |
| | 30 | 25 | 8,9 | PZD-2 | • 60630 | 500 | VARIANTA | 5.000 |
| | 35 | 30 | 8,9 | PZD-2 | • 60651 | 200 | SKV | 4.000 |
| | 35 | 30 | 8,9 | PZD-2 | • 60652 | 500 | VARIANTA | 5.000 |
| | 40 | 35 | 8,9 | PZD-2 | • 60674 | 200 | SKV | 4.000 |
| | 40 | 35 | 8,9 | PZD-2 | • 60675 | 500 | VARIANTA | 5.000 |
| | 45 | 40 | 8,9 | PZD-2 | • 60698 | 200 | SKV | 4.000 |
| | 45 | 40 | 8,9 | PZD-2 | • 60699 | 500 | VARIANTA | 5.000 |
| | 50 | 45 | 8,9 | PZD-2 | • 60723 | 200 | VARIANTA | 2.000 |
| | 55 | 50 | 8,9 | PZD-2 | • 60740 | 200 | VARIANTA | 2.000 |
| 60 | 55 | 8,9 | PZD-2 | • 60753 | 200 | VARIANTA | 2.000 | |
| 70 | 65 | 8,9 | PZD-2 | • 60770 | 200 | VARIANTA | 2.000 | |
| 80 | 75 | 8,9 | PZD-2 | • 60782 | 200 | VARIANTA | 2.000 | |



Uitvoering: platverzonken kop met freesholtes

Aandrijving: Pozi-Drive

Draadtype: variabele voldraad

Materiaal: koolstofstaal

Oppervlakte: verzinkt blauw, A3K **CHROME (VI) FREE +**

Kleurcode op het HECO-etiket

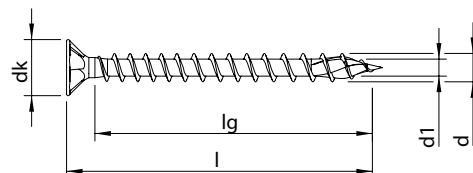

| Afmeting d x l [mm] | Draadlengte lg [mm] | Kopdiameter dk [mm] | Aandrijving | ETA | Artikelnummer | Aantal per verpakking [st.] | Type verpakking | Aantal per omverpakking [st.] |
|---------------------|---------------------|---------------------|-------------|-------------------------|-------------------------|-----------------------------|-----------------|-------------------------------|
| 5,0 + | 20 | 14 | 9,6 | PZD-2 | 60802 | 200 | SKV | 4.800 |
| | 20 | 14 | 9,6 | PZD-2 | 60803 | 500 | VARIANTA | 5.000 |
| | 25 | 19 | 9,6 | PZD-2 | 60814 | 200 | SKV | 4.000 |
| | 25 | 19 | 9,6 | PZD-2 | 60815 | 500 | VARIANTA | 5.000 |
| | 30 | 24 | 9,6 | PZD-2 | • 60828 | 200 | SKV | 4.000 |
| | 30 | 24 | 9,6 | PZD-2 | • 60829 | 500 | VARIANTA | 5.000 |
| | 35 | 29 | 9,6 | PZD-2 | • 60846 | 200 | SKV | 4.000 |
| | 35 | 29 | 9,6 | PZD-2 | • 60847 | 500 | VARIANTA | 5.000 |
| | 40 | 34 | 9,6 | PZD-2 | • 60865 | 200 | SKV | 4.000 |
| | 40 | 34 | 9,6 | PZD-2 | • 60866 | 500 | VARIANTA | 5.000 |
| | 45 | 39 | 9,6 | PZD-2 | • 60885 | 200 | VARIANTA | 2.000 |
| | 50 | 44 | 9,6 | PZD-2 | • 60898 | 200 | VARIANTA | 2.000 |
| | 55 | 49 | 9,6 | PZD-2 | • 60912 | 200 | VARIANTA | 2.000 |
| | 60 | 54 | 9,6 | PZD-2 | • 60922 | 200 | VARIANTA | 2.000 |
| | 70 | 64 | 9,6 | PZD-2 | • 60938 | 200 | VARIANTA | 2.000 |
| 80 | 74 | 9,6 | PZD-2 | • 60952 | 200 | VARIANTA | 2.000 | |
| 90 | 84 | 9,6 | PZD-2 | • 60963 | 200 | VARIANTA | 2.000 | |
| 100 | 94 | 9,6 | PZD-2 | • 60971 | 100 | VARIANTA | 1.000 | |
| 120 | 114 | 9,6 | PZD-2 | • 60983 | 100 | VARIANTA | 1.000 | |
| 6,0 + | 30 | 23 | 11,7 | PZD-3 | 60994 | 200 | VARIANTA | 2.000 |
| | 35 | 28 | 11,7 | PZD-3 | • 61000 | 200 | VARIANTA | 2.000 |
| | 40 | 33 | 11,7 | PZD-3 | • 61004 | 200 | VARIANTA | 2.000 |
| | 45 | 38 | 11,7 | PZD-3 | • 61018 | 200 | VARIANTA | 2.000 |
| | 50 | 43 | 11,7 | PZD-3 | • 61026 | 200 | VARIANTA | 2.000 |
| | 60 | 53 | 11,7 | PZD-3 | • 61049 | 200 | VARIANTA | 2.000 |
| | 70 | 63 | 11,7 | PZD-3 | • 61070 | 200 | VARIANTA | 2.000 |
| | 80 | 73 | 11,7 | PZD-3 | • 61083 | 100 | VARIANTA | 1.000 |
| | 90 | 83 | 11,7 | PZD-3 | • 61097 | 100 | VARIANTA | 1.000 |
| | 100 | 93 | 11,7 | PZD-3 | • 61106 | 100 | VARIANTA | 1.000 |
| | 110 | 103 | 11,7 | PZD-3 | • 61120 | 100 | VARIANTA | 1.000 |
| | 120 | 113 | 11,7 | PZD-3 | • 61127 | 100 | VARIANTA | 1.000 |

Uitvoering: platverzonken kop met freesholtes

Aandrijving: Pozi-Drive

Draadtype: variabele voldraad

Materiaal: koolstofstaal

Oppervlakte: verzinkt geel, A3L **CHROME (VI) FREE +**

Kleurcode op het HECO-etiket

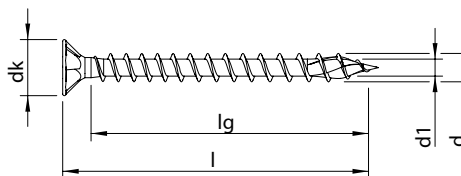

| Afmeting d x l [mm] | Draadlengte lg [mm] | Kopdiameter dk [mm] | Aandrijving | ETA | Artikelnummer | Aantal per verpakking [st.] | Type verpakking | Aantal per omverpakking [st.] |
|---------------------|---------------------|---------------------|-------------|-------|-----------------------|-----------------------------|-----------------|-------------------------------|
| 2,5 + | 16 | 13 | 4,9 | PZD-1 | 60017 | 1.000 | VARIANTA | 10.000 |
| | 20 | 17 | 4,9 | PZD-1 | 60025 | 1.000 | VARIANTA | 10.000 |
| | 25 | 22 | 4,9 | PZD-1 | 60029 | 1.000 | VARIANTA | 10.000 |
| 3,0 + | 16 | 12 | 5,9 | PZD-1 | 60060 | 1.000 | VARIANTA | 10.000 |
| | 20 | 16 | 5,9 | PZD-1 | 60080 | 1.000 | VARIANTA | 10.000 |
| | 25 | 21 | 5,9 | PZD-1 | 60098 | 1.000 | VARIANTA | 10.000 |
| | 30 | 26 | 5,9 | PZD-1 | 60115 | 1.000 | VARIANTA | 10.000 |
| | 35 | 31 | 5,9 | PZD-1 | 60137 | 1.000 | VARIANTA | 10.000 |
| | 40 | 36 | 5,9 | PZD-1 | 60150 | 500 | VARIANTA | 5.000 |
| 3,5 + | 16 | 11 | 7,3 | PZD-2 | 60193 | 1.000 | VARIANTA | 10.000 |
| | 20 | 15 | 7,3 | PZD-2 | 60212 | 1.000 | VARIANTA | 10.000 |
| | 25 | 20 | 7,3 | PZD-2 | 60229 | 1.000 | VARIANTA | 10.000 |
| | 30 | 25 | 7,3 | PZD-2 | 60254 | 1.000 | VARIANTA | 10.000 |
| | 35 | 30 | 7,3 | PZD-2 | 60277 | 1.000 | VARIANTA | 10.000 |
| | 40 | 35 | 7,3 | PZD-2 | 60301 | 500 | VARIANTA | 5.000 |
| | 45 | 40 | 7,3 | PZD-2 | 60319 | 500 | VARIANTA | 5.000 |
| | 50 | 45 | 7,3 | PZD-2 | 60335 | 500 | VARIANTA | 5.000 |
| 4,0 + | 16 | 11 | 7,9 | PZD-2 | 60371 | 1.000 | VARIANTA | 10.000 |
| | 20 | 15 | 7,9 | PZD-2 | 60388 | 1.000 | VARIANTA | 10.000 |
| | 25 | 20 | 7,9 | PZD-2 | 60404 | 1.000 | VARIANTA | 10.000 |
| | 30 | 25 | 7,9 | PZD-2 | 60427 | 1.000 | VARIANTA | 10.000 |
| | 35 | 30 | 7,9 | PZD-2 | 60451 | 500 | VARIANTA | 5.000 |
| | 40 | 35 | 7,9 | PZD-2 | 60474 | 500 | VARIANTA | 5.000 |
| | 45 | 40 | 7,9 | PZD-2 | 60500 | 500 | VARIANTA | 5.000 |
| | 50 | 45 | 7,9 | PZD-2 | 60524 | 500 | VARIANTA | 5.000 |
| | 60 | 55 | 7,9 | PZD-2 | 60555 | 200 | VARIANTA | 2.000 |
| | 70 | 65 | 7,9 | PZD-2 | 60569 | 200 | VARIANTA | 2.000 |



Uitvoering: platverzonken kop met freesholtes

Aandrijving: Pozi-Drive

Draadtype: variabele voldraad

Materiaal: koolstofstaal

Oppervlakte: verzinkt geel, A3L **CHROME (VI) FREE +**

Kleurcode op het HECO-etiket

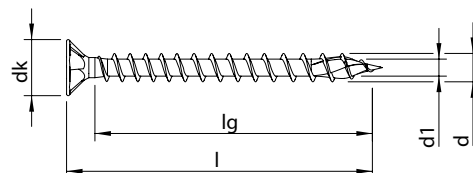

| Afmeting d x l [mm] | Draadlengte lg [mm] | Kopdiameter dk [mm] | Aandrijving | ETA | Artikelnummer | Aantal per verpakking [st.] | Type verpakking | Aantal per omverpakking [st.] |
|---------------------|---------------------|---------------------|-------------|-------|-------------------------|-----------------------------|-----------------|-------------------------------|
| 4,5 + | 16 | 11 | 8,9 | PZD-2 | 60584 | 1.000 | VARIANTA | 10.000 |
| | 20 | 15 | 8,9 | PZD-2 | 60597 | 1.000 | VARIANTA | 10.000 |
| | 25 | 20 | 8,9 | PZD-2 | • 60615 | 500 | VARIANTA | 5.000 |
| | 30 | 25 | 8,9 | PZD-2 | • 60632 | 500 | VARIANTA | 5.000 |
| | 35 | 30 | 8,9 | PZD-2 | • 60654 | 500 | VARIANTA | 5.000 |
| | 40 | 35 | 8,9 | PZD-2 | • 60677 | 500 | VARIANTA | 5.000 |
| | 45 | 40 | 8,9 | PZD-2 | • 60701 | 500 | VARIANTA | 5.000 |
| | 50 | 45 | 8,9 | PZD-2 | • 60724 | 200 | VARIANTA | 2.000 |
| | 60 | 55 | 8,9 | PZD-2 | • 60754 | 200 | VARIANTA | 2.000 |
| | 70 | 65 | 8,9 | PZD-2 | • 60771 | 200 | VARIANTA | 2.000 |
| 5,0 + | 20 | 14 | 9,6 | PZD-2 | 60805 | 500 | VARIANTA | 5.000 |
| | 25 | 19 | 9,6 | PZD-2 | 60817 | 500 | VARIANTA | 5.000 |
| | 30 | 24 | 9,6 | PZD-2 | • 60831 | 500 | VARIANTA | 5.000 |
| | 35 | 29 | 9,6 | PZD-2 | • 60850 | 500 | VARIANTA | 5.000 |
| | 40 | 34 | 9,6 | PZD-2 | • 60868 | 500 | VARIANTA | 5.000 |
| | 45 | 39 | 9,6 | PZD-2 | • 60886 | 200 | VARIANTA | 2.000 |
| | 50 | 44 | 9,6 | PZD-2 | • 60899 | 200 | VARIANTA | 2.000 |
| | 60 | 54 | 9,6 | PZD-2 | • 60923 | 200 | VARIANTA | 2.000 |
| 6,0 + | 30 | 23 | 11,7 | PZD-3 | 60995 | 200 | VARIANTA | 2.000 |
| | 35 | 28 | 11,7 | PZD-3 | • 61001 | 200 | VARIANTA | 2.000 |
| | 40 | 33 | 11,7 | PZD-3 | • 61005 | 200 | VARIANTA | 2.000 |
| | 45 | 38 | 11,7 | PZD-3 | • 61019 | 200 | VARIANTA | 2.000 |
| | 50 | 43 | 11,7 | PZD-3 | • 61027 | 200 | VARIANTA | 2.000 |
| | 60 | 53 | 11,7 | PZD-3 | • 61050 | 200 | VARIANTA | 2.000 |
| | 70 | 63 | 11,7 | PZD-3 | • 61071 | 200 | VARIANTA | 2.000 |

Uitvoering: platverzonken kop met freesholtes

Aandrijving: Pozi-Drive

Draadtype: variabele voldraad

Materiaal: roestvaststaal A2 1.4567

Oppervlakte: blank, glijcoating

Kleurcode op het HECO-etiket

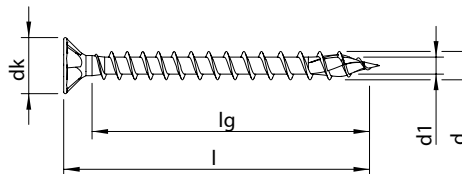

| Afmeting d x l [mm] | Draadlengte lg [mm] | Kopdiameter dk [mm] | Aandrijving | ETA | Artikelnummer | Aantal per verpakking [st.] | Type verpakking | Aantal per omverpakking [st.] |
|---------------------|---------------------|---------------------|-------------|-------|-------------------------|-----------------------------|-----------------|-------------------------------|
| 3,0 + | 20 | 16 | 5,9 | PZD-1 | 61617 | 200 | SKV | 4.800 |
| | 25 | 21 | 5,9 | PZD-1 | 61622 | 200 | SKV | 4.800 |
| | 30 | 26 | 5,9 | PZD-1 | 61624 | 200 | SKV | 4.800 |
| | 35 | 31 | 5,9 | PZD-1 | 61628 | 200 | SKV | 4.800 |
| 3,5 + | 16 | 12 | 7,3 | PZD-2 | 61630 | 200 | SKV | 4.800 |
| | 20 | 16 | 7,3 | PZD-2 | • 61631 | 200 | SKV | 4.800 |
| | 25 | 21 | 7,3 | PZD-2 | • 61634 | 200 | SKV | 4.800 |
| | 30 | 26 | 7,3 | PZD-2 | • 61636 | 200 | SKV | 4.800 |
| | 35 | 31 | 7,3 | PZD-2 | • 61640 | 200 | SKV | 4.000 |
| | 40 | 36 | 7,3 | PZD-2 | • 61646 | 200 | SKV | 4.000 |
| 4,0 + | 20 | 15 | 7,9 | PZD-2 | 61656 | 200 | SKV | 4.800 |
| | 25 | 20 | 7,9 | PZD-2 | • 61661 | 200 | SKV | 4.800 |
| | 30 | 25 | 7,9 | PZD-2 | • 61665 | 200 | SKV | 4.800 |
| | 35 | 30 | 7,9 | PZD-2 | • 61671 | 200 | SKV | 4.000 |
| | 40 | 35 | 7,9 | PZD-2 | • 61676 | 200 | SKV | 4.000 |
| | 45 | 40 | 7,9 | PZD-2 | • 61680 | 200 | SKV | 4.000 |
| | 50 | 45 | 7,9 | PZD-2 | • 61684 | 200 | SKV | 4.000 |
| | 60 | 55 | 7,9 | PZD-2 | • 61688 | 200 | VARIANTA | 2.000 |
| 4,5 + | 25 | 20 | 8,9 | PZD-2 | • 61691 | 200 | SKV | 4.800 |
| | 30 | 25 | 8,9 | PZD-2 | • 61693 | 200 | SKV | 4.000 |
| | 35 | 30 | 8,9 | PZD-2 | • 61695 | 200 | SKV | 4.000 |
| | 40 | 35 | 8,9 | PZD-2 | • 61697 | 200 | SKV | 4.000 |
| | 45 | 40 | 8,9 | PZD-2 | • 61702 | 200 | SKV | 4.000 |
| | 50 | 45 | 8,9 | PZD-2 | • 61708 | 200 | VARIANTA | 2.000 |
| | 60 | 55 | 8,9 | PZD-2 | • 61713 | 200 | VARIANTA | 2.000 |



Uitvoering: platverzonken kop met freesholtes

Aandrijving: Pozi-Drive

Draadtype: variabele voldraad

Materiaal: roestvaststaal A2 1.4567

Oppervlakte: blank, glijcoating

Kleurcode op het
HECO-etiket

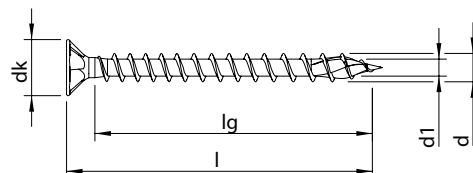

| Afmeting d x l [mm] | Draadlengte lg [mm] | Kopdiameter dk [mm] | Aandrijving | ETA | Artikelnummer | Aantal per verpakking [st.] | Type verpakking | Aantal per om- verpakking [st.] |
|------------------------|------------------------|------------------------|-------------|-------|---------------------------|--------------------------------|--------------------|------------------------------------|
| 5,0 + | 25 | 19 | 9,6 | PZD-2 | 61727 | 200 | SKV | 4.000 |
| | 30 | 24 | 9,6 | PZD-2 | • 61730 | 200 | SKV | 4.000 |
| | 35 | 29 | 9,6 | PZD-2 | • 61735 | 200 | SKV | 4.000 |
| | 40 | 34 | 9,6 | PZD-2 | • 61745 | 200 | SKV | 4.000 |
| | 45 | 39 | 9,6 | PZD-2 | • 61751 | 200 | VARIANTA | 2.000 |
| | 50 | 44 | 9,6 | PZD-2 | • 61761 | 200 | VARIANTA | 2.000 |
| | 60 | 54 | 9,6 | PZD-2 | • 61774 | 200 | VARIANTA | 2.000 |
| | 70 | 64 | 9,6 | PZD-2 | • 61785 | 200 | VARIANTA | 2.000 |
| 6,0 + | 80 | 74 | 9,6 | PZD-2 | • 61795 | 200 | VARIANTA | 2.000 |
| | 60 | 53 | 11,7 | PZD-3 | • 61807 | 200 | VARIANTA | 2.000 |
| | 80 | 73 | 11,7 | PZD-3 | • 61817 | 100 | VARIANTA | 1.000 |
| | 100 | 60 | 11,7 | PZD-3 | • 61825 * | 100 | VARIANTA | 1.000 |
| | 120 | 72 | 11,7 | PZD-3 | • 61832 * | 100 | VARIANTA | 1.000 |

* afwijkende uitvoering met deeldraad

Uitvoering: platverzonken kop met freesholtes

Aandrijving: Pozi-Drive

Draadtype: deeldraad

Materiaal: koolstofstaal

Oppervlakte: verzinkt blauw, A3K **CHROME (VI) FREE +**

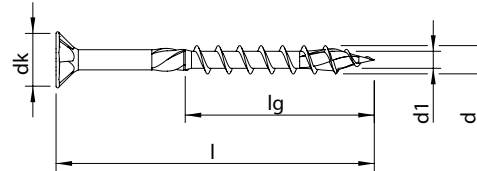

Kleurcode op het HECO-etiket

| Afmeting d x l [mm] | Draadlengte lg [mm] | Kopdiameter dk [mm] | Aandrijving | ETA | Artikelnummer | Aantal per verpakking [st.] | Type verpakking | Aantal per omverpakking [st.] |
|---------------------|---------------------|---------------------|-------------|-------|-----------------------|-----------------------------|-----------------|-------------------------------|
| 3,0 + | 30 | 18 | 5,9 | PZD-1 | 60121 | 1.000 | VARIANTA | 10.000 |
| | 35 | 21 | 5,9 | PZD-1 | 60142 | 1.000 | VARIANTA | 10.000 |
| | 40 | 24 | 5,9 | PZD-1 | 60155 | 500 | VARIANTA | 5.000 |
| | 45 | 27 | 5,9 | PZD-1 | 60167 | 500 | VARIANTA | 5.000 |
| 3,5 + | 25 | 15 | 7,3 | PZD-2 | 60234 | 1.000 | VARIANTA | 10.000 |
| | 30 | 18 | 7,3 | PZD-2 | 60259 | 1.000 | VARIANTA | 10.000 |
| | 35 | 21 | 7,3 | PZD-2 | 60282 | 1.000 | VARIANTA | 10.000 |
| | 40 | 24 | 7,3 | PZD-2 | 60306 | 500 | VARIANTA | 5.000 |
| | 45 | 27 | 7,3 | PZD-2 | 60324 | 500 | VARIANTA | 5.000 |
| 4,0 + | 50 | 30 | 7,3 | PZD-2 | 60340 | 500 | VARIANTA | 5.000 |
| | 30 | 18 | 7,9 | PZD-2 | 60432 | 1.000 | VARIANTA | 10.000 |
| | 35 | 21 | 7,9 | PZD-2 | 60456 | 500 | VARIANTA | 5.000 |
| | 40 | 24 | 7,9 | PZD-2 | 60481 | 500 | VARIANTA | 5.000 |
| | 45 | 27 | 7,9 | PZD-2 | 60506 | 500 | VARIANTA | 5.000 |
| | 50 | 30 | 7,9 | PZD-2 | 60530 | 500 | VARIANTA | 5.000 |
| | 60 | 36 | 7,9 | PZD-2 | 60558 | 200 | VARIANTA | 2.000 |
| | 70 | 42 | 7,9 | PZD-2 | 60572 | 200 | VARIANTA | 2.000 |



Uitvoering: platverzonken kop met freesholtes

Aandrijving: Pozi-Drive

Draadtype: deeldraad

Materiaal: koolstofstaal

Oppervlakte: verzinkt blauw, A3K **CHROME (VI) FREE +**

Kleurcode op het HECO-etiket

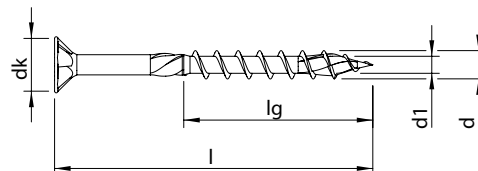

| Afmeting d x l [mm] | Draadlengte lg [mm] | Kopdiameter dk [mm] | Aandrijving | ETA | Artikelnummer | Aantal per verpakking [st.] | Type verpakking | Aantal per omverpakking [st.] | |
|---------------------|---------------------|---------------------|-------------|-------|-----------------------|-----------------------------|-----------------|-------------------------------|-------|
| 4,5 + | 30 | 18 | 8,9 | PZD-2 | • | 60638 | 500 | VARIANTA | 5.000 |
| | 35 | 21 | 8,9 | PZD-2 | • | 60659 | 500 | VARIANTA | 5.000 |
| | 40 | 24 | 8,9 | PZD-2 | • | 60682 | 500 | VARIANTA | 5.000 |
| | 45 | 27 | 8,9 | PZD-2 | • | 60706 | 500 | VARIANTA | 5.000 |
| | 50 | 30 | 8,9 | PZD-2 | • | 60729 | 200 | VARIANTA | 2.000 |
| | 60 | 36 | 8,9 | PZD-2 | • | 60757 | 200 | VARIANTA | 2.000 |
| | 70 | 42 | 8,9 | PZD-2 | • | 60774 | 200 | VARIANTA | 2.000 |
| | 80 | 48 | 8,9 | PZD-2 | • | 60784 | 200 | VARIANTA | 2.000 |
| 5,0 + | 30 | 18 | 9,6 | PZD-2 | • | 60837 | 500 | VARIANTA | 5.000 |
| | 35 | 21 | 9,6 | PZD-2 | • | 60855 | 500 | VARIANTA | 5.000 |
| | 40 | 24 | 9,6 | PZD-2 | • | 60873 | 500 | VARIANTA | 5.000 |
| | 45 | 27 | 9,6 | PZD-2 | • | 60889 | 200 | VARIANTA | 2.000 |
| | 50 | 30 | 9,6 | PZD-2 | • | 60903 | 200 | VARIANTA | 2.000 |
| | 60 | 36 | 9,6 | PZD-2 | • | 60927 | 200 | VARIANTA | 2.000 |
| | 70 | 42 | 9,6 | PZD-2 | • | 60943 | 200 | VARIANTA | 2.000 |
| | 80 | 48 | 9,6 | PZD-2 | • | 60955 | 200 | VARIANTA | 2.000 |
| | 90 | 54 | 9,6 | PZD-2 | • | 60965 | 200 | VARIANTA | 2.000 |
| | 100 | 60 | 9,6 | PZD-2 | • | 60974 | 100 | VARIANTA | 1.000 |
| 120 | 60 | 9,6 | PZD-2 | • | 60986 | 100 | VARIANTA | 1.000 | |

Uitvoering: platverzonken kop met freesholtes

Aandrijving: Pozi-Drive

Draadtype: deeldraad

Materiaal: koolstofstaal

Oppervlakte: verzinkt blauw, A3K **CHROME (VI) FREE +**

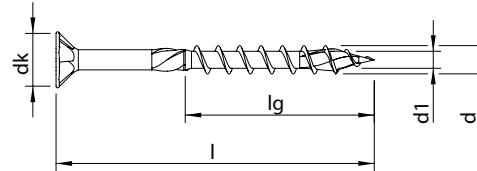

| Afmeting d x l [mm] | Draadlengte lg [mm] | Kopdiameter dk [mm] | Aandrijving | ETA | Artikelnummer | Aantal per verpakking [st.] | Type verpakking | Aantal per omverpakking [st.] | |
|---------------------|---------------------|---------------------|-------------|-------|-----------------------|-----------------------------|-----------------|-------------------------------|-------|
| 6,0 | 40 | 24 | 11,7 | PZD-3 | ● | 61008 | 200 | VARIANTA | 2.000 |
| | 45 | 27 | 11,7 | PZD-3 | ● | 61022 | 200 | VARIANTA | 2.000 |
| | 50 | 30 | 11,7 | PZD-3 | ● | 61031 | 200 | VARIANTA | 2.000 |
| | 60 | 36 | 11,7 | PZD-3 | ● | 61054 | 200 | VARIANTA | 2.000 |
| | 70 | 42 | 11,7 | PZD-3 | ● | 61074 | 200 | VARIANTA | 2.000 |
| | 80 | 48 | 11,7 | PZD-3 | ● | 61086 | 100 | VARIANTA | 1.000 |
| | 90 | 54 | 11,7 | PZD-3 | ● | 61100 | 100 | VARIANTA | 1.000 |
| | 100 | 60 | 11,7 | PZD-3 | ● | 61109 | 100 | VARIANTA | 1.000 |
| | 110 | 66 | 11,7 | PZD-3 | ● | 61122 | 100 | VARIANTA | 1.000 |
| | 120 | 72 | 11,7 | PZD-3 | ● | 61130 | 100 | VARIANTA | 1.000 |
| | 130 | 72 | 11,7 | PZD-3 | ● | 61140 | 100 | VARIANTA | 1.000 |
| | 140 | 72 | 11,7 | PZD-3 | ● | 61145 | 100 | VARIANTA | 1.000 |
| | 150 | 72 | 11,7 | PZD-3 | ● | 61154 | 100 | VARIANTA | 800 |
| | 160 | 72 | 11,7 | PZD-3 | ● | 61161 | 100 | VARIANTA | 800 |
| | 180 | 72 | 11,7 | PZD-3 | ● | 61170 | 100 | VARIANTA | 400 |
| 200 | 72 | 11,7 | PZD-3 | ● | 61178 | 100 | VARIANTA | 400 | |



Uitvoering: platverzonken kop met freesholtes

Aandrijving: Pozi-Drive

Draadtype: deeldraad

Materiaal: koolstofstaal

Oppervlakte: verzinkt geel, A3L **CHROME (VI) FREE +**

Kleurcode op het HECO-etiket

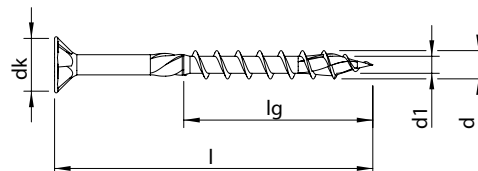

| Afmeting d x l [mm] | Draadlengte lg [mm] | Kopdiameter dk [mm] | Aandrijving | ETA | Artikelnummer | Aantal per verpakking [st.] | Type verpakking | Aantal per omverpakking [st.] | |
|---------------------|---------------------|---------------------|-------------|-------|-----------------------|-----------------------------|-----------------|-------------------------------|--------|
| 3,5 + | 25 | 15 | 7,3 | PZD-2 | • | 60235 | 1.000 | VARIANTA | 10.000 |
| | 30 | 18 | 7,3 | PZD-2 | • | 60260 | 1.000 | VARIANTA | 10.000 |
| | 35 | 21 | 7,3 | PZD-2 | • | 60283 | 1.000 | VARIANTA | 10.000 |
| | 40 | 24 | 7,3 | PZD-2 | • | 60307 | 500 | VARIANTA | 5.000 |
| | 45 | 27 | 7,3 | PZD-2 | • | 60325 | 500 | VARIANTA | 5.000 |
| | 50 | 30 | 7,3 | PZD-2 | • | 60341 | 500 | VARIANTA | 5.000 |
| 4,0 + | 30 | 18 | 7,9 | PZD-2 | • | 60433 | 1.000 | VARIANTA | 10.000 |
| | 35 | 21 | 7,9 | PZD-2 | • | 60457 | 500 | VARIANTA | 5.000 |
| | 40 | 24 | 7,9 | PZD-2 | • | 60483 | 500 | VARIANTA | 5.000 |
| | 45 | 27 | 7,9 | PZD-2 | • | 60507 | 500 | VARIANTA | 5.000 |
| | 50 | 30 | 7,9 | PZD-2 | • | 60532 | 500 | VARIANTA | 5.000 |
| | 60 | 36 | 7,9 | PZD-2 | • | 60559 | 200 | VARIANTA | 2.000 |
| 4,5 + | 70 | 42 | 7,9 | PZD-2 | • | 60573 | 200 | VARIANTA | 2.000 |
| | 30 | 18 | 8,9 | PZD-2 | • | 60639 | 500 | VARIANTA | 5.000 |
| | 35 | 21 | 8,9 | PZD-2 | • | 60660 | 500 | VARIANTA | 5.000 |
| | 40 | 24 | 8,9 | PZD-2 | • | 60683 | 500 | VARIANTA | 5.000 |
| | 45 | 27 | 8,9 | PZD-2 | • | 60707 | 500 | VARIANTA | 5.000 |
| | 50 | 30 | 8,9 | PZD-2 | • | 60730 | 200 | VARIANTA | 2.000 |
| | 60 | 36 | 8,9 | PZD-2 | • | 60758 | 200 | VARIANTA | 2.000 |
| | 70 | 42 | 8,9 | PZD-2 | • | 60775 | 200 | VARIANTA | 2.000 |
| 80 | 48 | 8,9 | PZD-2 | • | 60785 | 200 | VARIANTA | 2.000 | |

Uitvoering: platverzonken kop met freesholtes

Aandrijving: Pozi-Drive

Draadtype: deeldraad

Materiaal: koolstofstaal

Oppervlakte: verzinkt geel, A3L **CHROME (VI) FREE +**

Kleurcode op het HECO-etiket

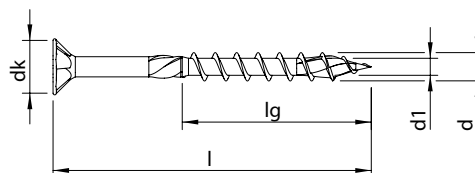

| Afmeting d x l [mm] | Draadlengte lg [mm] | Kopdiameter dk [mm] | Aandrijving | ETA | Artikelnummer | Aantal per verpakking [st.] | Type verpakking | Aantal per omverpakking [st.] | |
|---------------------|---------------------|---------------------|-------------|-------|---------------|-----------------------------|-----------------|-------------------------------|-------|
| 5,0 + | 35 | 21 | 9,6 | PZD-2 | • | 60856 | 500 | VARIANTA | 5.000 |
| | 40 | 24 | 9,6 | PZD-2 | • | 60874 | 500 | VARIANTA | 2.500 |
| | 45 | 27 | 9,6 | PZD-2 | • | 60890 | 200 | VARIANTA | 2.000 |
| | 50 | 30 | 9,6 | PZD-2 | • | 60904 | 200 | VARIANTA | 2.000 |
| | 60 | 36 | 9,6 | PZD-2 | • | 60928 | 200 | VARIANTA | 2.000 |
| | 70 | 42 | 9,6 | PZD-2 | • | 60944 | 200 | VARIANTA | 2.000 |
| | 80 | 48 | 9,6 | PZD-2 | • | 60956 | 200 | VARIANTA | 2.000 |
| | 90 | 54 | 9,6 | PZD-2 | • | 60966 | 200 | VARIANTA | 2.000 |
| | 100 | 60 | 9,6 | PZD-2 | • | 60977 | 100 | VARIANTA | 1.000 |
| | 120 | 60 | 9,6 | PZD-2 | • | 60987 | 100 | VARIANTA | 1.000 |
| 6,0 + | 45 | 27 | 11,7 | PZD-3 | • | 61023 | 200 | VARIANTA | 2.000 |
| | 50 | 30 | 11,7 | PZD-3 | • | 61032 | 200 | VARIANTA | 2.000 |
| | 60 | 36 | 11,7 | PZD-3 | • | 61055 | 200 | VARIANTA | 2.000 |
| | 70 | 42 | 11,7 | PZD-3 | • | 61075 | 200 | VARIANTA | 2.000 |
| | 80 | 48 | 11,7 | PZD-3 | • | 61087 | 100 | VARIANTA | 1.000 |
| | 90 | 54 | 11,7 | PZD-3 | • | 61101 | 100 | VARIANTA | 1.000 |
| | 100 | 60 | 11,7 | PZD-3 | • | 61110 | 100 | VARIANTA | 1.000 |
| | 120 | 72 | 11,7 | PZD-3 | • | 61131 | 100 | VARIANTA | 1.000 |



Uitvoering: kleine platverzonken kop

Aandrijving: Pozi-Drive

Draadtype: variabele voldraad

Materiaal: koolstofstaal

Oppervlakte: verzinkt blauw, A3K **CHROME (VI) FREE +**

Kleurcode op het HECO-etiket

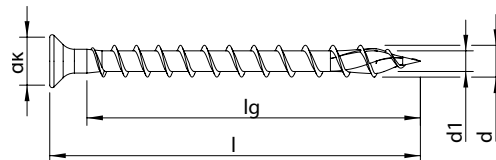

| Afmeting d x l [mm] | Draadlengte lg [mm] | Kopdiameter dk [mm] | Aandrijving | ETA | Artikelnummer | Aantal per verpakking [st.] | Type verpakking | Aantal per omverpakking [st.] |
|---------------------|---------------------|---------------------|-------------|-------|-----------------------|-----------------------------|-----------------|-------------------------------|
| 3,0 | 12 | 9 | 5,0 | PZD-1 | 60046 | 200 | SKV | 4.800 |
| + | 16 | 13 | 5,0 | PZD-1 | 60070 | 200 | SKV | 4.800 |
| | 20 | 17 | 5,0 | PZD-1 | 60091 | 200 | SKV | 4.800 |
| | 25 | 22 | 5,0 | PZD-1 | 60109 | 200 | SKV | 4.800 |

Uitvoering: platverzonken kop met koppatboring 2,4 mm *

Aandrijving: Pozi-Drive

Draadtype: variabele voldraad

Materiaal: koolstofstaal

Oppervlakte: verzinkt blauw, A3K **CHROME (VI) FREE +**

Kleurcode op het HECO-etiket

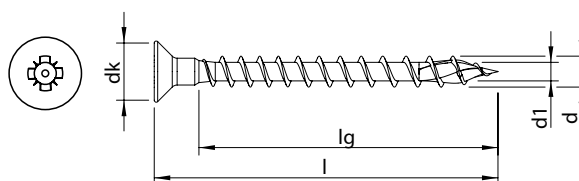

| Afmeting d x l [mm] | Draadlengte lg [mm] | Kopdiameter dk [mm] | Aandrijving | ETA | Artikelnummer | Aantal per verpakking [st.] | Type verpakking | Aantal per omverpakking [st.] | |
|---------------------|---------------------|---------------------|-------------|-------|---------------|-----------------------------|-----------------|-------------------------------|-------|
| 4,0 + | 25 | 17 | 7,9 | PZD-2 | • | 60399 | 200 | SKV | 4.800 |
| | 30 | 22 | 7,9 | PZD-2 | • | 60422 | 200 | SKV | 4.800 |
| | 35 | 27 | 7,9 | PZD-2 | • | 60446 | 200 | SKV | 4.000 |
| | 40 | 32 | 7,9 | PZD-2 | • | 60467 | 200 | SKV | 4.000 |
| | 45 | 37 | 7,9 | PZD-2 | • | 60496 | 200 | SKV | 4.000 |
| | 50 | 42 | 7,9 | PZD-2 | • | 60518 | 200 | SKV | 4.000 |
| | 60 | 52 | 7,9 | PZD-2 | • | 60553 | 200 | VARIANTA | 2.000 |
| 4,5 + | 20 | 11 | 8,9 | PZD-2 | | 60592 | 200 | SKV | 4.800 |
| | 25 | 16 | 8,9 | PZD-2 | • | 60609 | 200 | SKV | 4.800 |
| | 30 | 21 | 8,9 | PZD-2 | • | 60627 | 200 | SKV | 4.000 |
| | 35 | 26 | 8,9 | PZD-2 | • | 60649 | 200 | SKV | 4.000 |
| | 40 | 31 | 8,9 | PZD-2 | • | 60672 | 200 | SKV | 4.000 |
| | 45 | 36 | 8,9 | PZD-2 | • | 60696 | 200 | SKV | 4.000 |
| | 50 | 41 | 8,9 | PZD-2 | • | 60718 | 200 | VARIANTA | 2.000 |
| | 60 | 51 | 8,9 | PZD-2 | • | 60749 | 200 | VARIANTA | 2.000 |
| 5,0 + | 60 | 50 | 9,8 | PZD-2 | • | 60921 | 200 | VARIANTA | 2.000 |
| | 70 | 60 | 9,8 | PZD-2 | • | 60937 | 200 | VARIANTA | 2.000 |
| | 80 | 70 | 9,8 | PZD-2 | • | 60951 | 200 | VARIANTA | 2.000 |

* Bijpassende kapjes vindt u op pagina 179



Uitvoering: rondkop

Aandrijving: T-Drive

Draadtype: variabele voldraad

Materiaal: koolstofstaal

Oppervlakte: verzinkt blauw, A3K **CHROME (VI) FREE +**

Kleurcode op het HECO-etiket

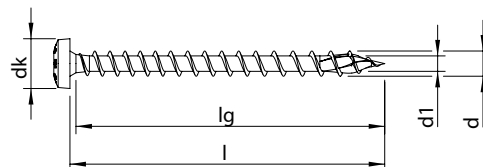

| Afmeting d x l [mm] | Draadlengte lg [mm] | Kopdiameter dk [mm] | Aandrijving | ETA | Artikelnummer | Aantal per verpakking [st.] | Type verpakking | Aantal per omverpakking [st.] |
|---------------------|---------------------|---------------------|-------------|-------|--------------------|-----------------------------|-----------------|-------------------------------|
| 3,5 ★ | 12 | 10 | 6,9 | T-20 | 60180 | 1.000 | VARIANTA | 10.000 |
| | 16 | 14 | 6,9 | T-20 | 60203 | 1.000 | VARIANTA | 10.000 |
| | 20 | 18 | 6,9 | T-20 | 60223 | 1.000 | VARIANTA | 10.000 |
| | 25 | 23 | 6,9 | T-20 | 62665 NIEUW | 200 | SKV | 4.000 |
| | 25 | 23 | 6,9 | T-20 | 60246 | 1.000 | VARIANTA | 10.000 |
| | 30 | 28 | 6,9 | T-20 | 62666 NIEUW | 200 | SKV | 4.000 |
| | 30 | 28 | 6,9 | T-20 | 60268 | 1.000 | VARIANTA | 10.000 |
| | 35 | 33 | 6,9 | T-20 | 62667 NIEUW | 200 | SKV | 4.000 |
| | 35 | 33 | 6,9 | T-20 | 60292 | 1.000 | VARIANTA | 5.000 |
| 4,0 ★ | 12 | 10 | 7,9 | T-20 | 60359 | 1.000 | VARIANTA | 10.000 |
| | 16 | 14 | 7,9 | T-20 | 60380 | 1.000 | VARIANTA | 10.000 |
| | 20 | 18 | 7,9 | T-20 | 62668 NIEUW | 200 | SKV | 4.800 |
| | 20 | 18 | 7,9 | T-20 | 60397 | 1.000 | VARIANTA | 10.000 |
| | 25 | 23 | 7,9 | T-20 | 62669 NIEUW | 200 | SKV | 4.000 |
| | 25 | 23 | 7,9 | T-20 | 60419 | 1.000 | VARIANTA | 5.000 |
| | 30 | 28 | 7,9 | T-20 | 62670 NIEUW | 200 | SKV | 4.000 |
| | 30 | 28 | 7,9 | T-20 | 60442 | 500 | VARIANTA | 5.000 |
| | 35 | 33 | 7,9 | T-20 | 62671 NIEUW | 200 | SKV | 4.000 |
| | 35 | 33 | 7,9 | T-20 | 60465 | 500 | VARIANTA | 5.000 |
| | 40 | 38 | 7,9 | T-20 | 62672 NIEUW | 200 | SKV | 4.000 |
| | 40 | 38 | 7,9 | T-20 | 60494 | 500 | VARIANTA | 5.000 |
| | 45 | 43 | 7,9 | T-20 | 62673 NIEUW | 200 | SKV | 4.000 |
| | 45 | 43 | 7,9 | T-20 | 60517 | 500 | VARIANTA | 5.000 |
| | 50 | 48 | 7,9 | T-20 | 62674 NIEUW | 200 | SKV | 4.000 |
| 50 | 48 | 7,9 | T-20 | 60543 | 500 | VARIANTA | 5.000 | |

Uitvoering: rondkop

Aandrijving: T-Drive

Draadtype: variabele voldraad

Materiaal: koolstofstaal

Oppervlakte: verzinkt blauw, A3K **CHROME (VI) FREE +**

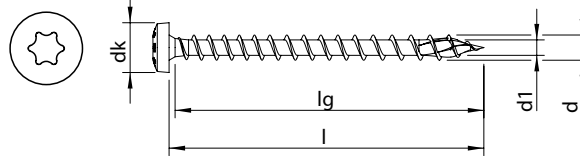

| Afmeting d x l [mm] | Draadlengte lg [mm] | Kopdiameter dk [mm] | Aandrijving | ETA | Artikelnummer | Aantal per verpakking [st.] | Type verpakking | Aantal per omverpakking [st.] |
|---------------------|---------------------|---------------------|-------------|-------|---------------|-----------------------------|-----------------|-------------------------------|
| 4,5 ★ | 16 | 13 | 8,9 | T-20 | 60589 | 500 | VARIANTA | 5.000 |
| | 20 | 17 | 8,9 | T-20 | 62675 NIEUW | 200 | SKV | 4.800 |
| | 20 | 17 | 8,9 | T-20 | 60607 | 500 | VARIANTA | 5.000 |
| | 25 | 22 | 8,9 | T-20 | 62676 NIEUW | 200 | SKV | 4.000 |
| | 25 | 22 | 8,9 | T-20 | 60624 | 500 | VARIANTA | 5.000 |
| | 30 | 27 | 8,9 | T-20 | 62677 NIEUW | 200 | SKV | 4.000 |
| | 30 | 27 | 8,9 | T-20 | 60646 | 500 | VARIANTA | 5.000 |
| | 35 | 32 | 8,9 | T-20 | 62678 NIEUW | 200 | SKV | 4.000 |
| | 35 | 32 | 8,9 | T-20 | 60669 | 500 | VARIANTA | 5.000 |
| | 40 | 37 | 8,9 | T-20 | 62679 NIEUW | 200 | SKV | 4.000 |
| | 40 | 37 | 8,9 | T-20 | 60692 | 500 | VARIANTA | 5.000 |
| | 45 | 42 | 8,9 | T-20 | 62680 NIEUW | 200 | SKV | 4.000 |
| | 45 | 42 | 8,9 | T-20 | 60716 | 500 | VARIANTA | 2.500 |
| | 50 | 47 | 8,9 | T-20 | 60739 | 200 | VARIANTA | 2.000 |
| 5,0 ★ | 16 | 13 | 9,6 | T-20 | 60799 | 500 | VARIANTA | 5.000 |
| | 20 | 17 | 9,6 | T-20 | 62681 NIEUW | 200 | SKV | 4.000 |
| | 20 | 17 | 9,6 | T-20 | 60813 | 500 | VARIANTA | 5.000 |
| | 25 | 22 | 9,6 | T-20 | 62682 NIEUW | 200 | SKV | 4.000 |
| | 25 | 22 | 9,6 | T-20 | 60826 | 500 | VARIANTA | 5.000 |
| | 30 | 27 | 9,6 | T-20 | 62683 NIEUW | 200 | SKV | 4.000 |
| | 30 | 27 | 9,6 | T-20 | 60845 | 500 | VARIANTA | 5.000 |
| | 35 | 32 | 9,6 | T-20 | 62684 NIEUW | 200 | SKV | 4.000 |
| | 35 | 32 | 9,6 | T-20 | 60863 | 500 | VARIANTA | 2.500 |
| | 40 | 37 | 9,6 | T-20 | 60884 | 200 | VARIANTA | 2.000 |
| | 50 | 47 | 9,6 | T-20 | 60911 | 200 | VARIANTA | 2.000 |
| 60 | 57 | 9,6 | T-20 | 60934 | 200 | VARIANTA | 2.000 | |
| 6,0 ★ | 40 | 36 | 11,6 | T-30 | 61011 | 200 | VARIANTA | 2.000 |
| | 50 | 46 | 11,6 | T-30 | 61037 | 200 | VARIANTA | 2.000 |
| | 60 | 56 | 11,6 | T-30 | 61060 | 200 | VARIANTA | 1.000 |
| | 80 | 76 | 11,6 | T-30 | 61093 | 100 | VARIANTA | 1.000 |



Uitvoering: rondkop
Aandrijving: T-Drive
Draadtype: variabele voldraad
Materiaal: roestvaststaal A2 1.4567
Oppervlakte: blank, glijcoating

Kleurcode op het HECO-etiket

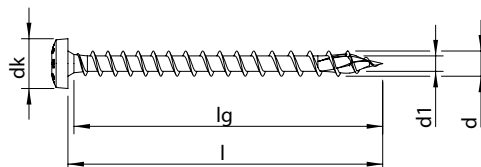

| Afmeting d x l [mm] | Draadlengte lg [mm] | Kopdiameter dk [mm] | Aandrijving | ETA | Artikelnummer | Aantal per verpakking [st.] | Type verpakking | Aantal per omverpakking [st.] |
|---------------------|---------------------|---------------------|-------------|------|-----------------------|-----------------------------|-----------------|-------------------------------|
| 3,0 | 20 | 18 | 5,9 | T-10 | 61978 | 200 | SKV | 4.800 |
| | 30 | 28 | 5,9 | T-10 | 61979 | 200 | SKV | 4.000 |
| 3,5 | 20 | 18 | 6,9 | T-20 | 61980 | 200 | SKV | 4.800 |
| | 30 | 28 | 6,9 | T-20 | 61981 | 200 | SKV | 4.800 |
| 4,0 | 20 | 18 | 7,9 | T-20 | 61982 | 200 | SKV | 4.800 |
| | 25 | 23 | 7,9 | T-20 | 61983 | 200 | SKV | 4.000 |
| | 30 | 28 | 7,9 | T-20 | 61984 | 200 | SKV | 4.000 |
| | 35 | 33 | 7,9 | T-20 | 61985 | 200 | SKV | 4.000 |
| | 40 | 38 | 7,9 | T-20 | 61986 | 200 | SKV | 4.000 |
| | 45 | 43 | 7,9 | T-20 | 61987 | 200 | SKV | 4.000 |
| 5,0 | 50 | 48 | 7,9 | T-20 | 61988 | 200 | SKV | 4.000 |
| | 25 | 22 | 9,6 | T-20 | 61989 | 200 | SKV | 4.000 |
| | 30 | 27 | 9,6 | T-20 | 61990 | 200 | SKV | 4.000 |
| | 40 | 37 | 9,6 | T-20 | 61991 | 200 | SKV | 4.000 |
| | 50 | 47 | 9,6 | T-20 | 61992 | 200 | VARIANTA | 2.000 |

Uitvoering: rondkop

Aandrijving: Pozi-Drive

Draadtype: variabele voldraad

Materiaal: koolstofstaal

Oppervlakte: verzinkt blauw, A3K **CHROME (VI) FREE +**

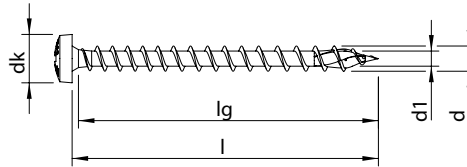

| Afmeting d x l [mm] | Draadlengte lg [mm] | Kopdiameter dk [mm] | Aandrijving | ETA | Artikelnummer | Aantal per verpakking [st.] | Type verpakking | Aantal per omverpakking [st.] | |
|---------------------|---------------------|---------------------|-------------|-------|---------------|-----------------------------|-----------------|-------------------------------|--------|
| 3,0 | 12 | 10 | 5,9 | PZD-1 | 60042 | 200 | SKV | 4.800 | |
| | + | 12 | 10 | 5,9 | PZD-1 | 60043 | 1.000 | VARIANTA | 10.000 |
| | 15 | 13 | 5,9 | PZD-1 | 60053 | 200 | SKV | 4.800 | |
| | 15 | 13 | 5,9 | PZD-1 | 60054 | 1.000 | VARIANTA | 10.000 | |
| | 16 | 14 | 5,9 | PZD-1 | 60066 | 200 | SKV | 4.800 | |
| | 16 | 14 | 5,9 | PZD-1 | 60067 | 1.000 | VARIANTA | 10.000 | |
| | 20 | 18 | 5,9 | PZD-1 | 60086 | 200 | SKV | 4.800 | |
| | 20 | 18 | 5,9 | PZD-1 | 60087 | 1.000 | VARIANTA | 10.000 | |
| | 25 | 23 | 5,9 | PZD-1 | 60105 | 200 | SKV | 4.800 | |
| | 25 | 23 | 5,9 | PZD-1 | 60106 | 1.000 | VARIANTA | 10.000 | |
| | 30 | 28 | 5,9 | PZD-1 | 60126 | 200 | SKV | 4.000 | |
| | 30 | 28 | 5,9 | PZD-1 | 60127 | 1.000 | VARIANTA | 10.000 | |
| | 3,5 | 12 | 10 | 6,9 | PZD-2 | 60178 | 200 | SKV | 4.800 |
| + | | 12 | 10 | 6,9 | PZD-2 | 60179 | 1.000 | VARIANTA | 10.000 |
| 15 | | 13 | 6,9 | PZD-2 | 60188 | 200 | SKV | 4.800 | |
| 15 | | 13 | 6,9 | PZD-2 | 60189 | 1.000 | VARIANTA | 10.000 | |
| 16 | | 14 | 6,9 | PZD-2 | • | 60199 | 200 | SKV | 4.800 |
| 16 | | 14 | 6,9 | PZD-2 | • | 60200 | 1.000 | VARIANTA | 10.000 |
| 20 | | 18 | 6,9 | PZD-2 | • | 60219 | 200 | SKV | 4.800 |
| 20 | | 18 | 6,9 | PZD-2 | • | 60220 | 1.000 | VARIANTA | 10.000 |
| 25 | | 23 | 6,9 | PZD-2 | • | 60242 | 200 | SKV | 4.000 |
| 25 | | 23 | 6,9 | PZD-2 | • | 60243 | 1.000 | VARIANTA | 10.000 |
| 30 | | 28 | 6,9 | PZD-2 | • | 60265 | 200 | SKV | 4.000 |
| 30 | | 28 | 6,9 | PZD-2 | • | 60266 | 1.000 | VARIANTA | 10.000 |
| 35 | | 33 | 6,9 | PZD-2 | • | 60288 | 200 | SKV | 4.000 |
| 35 | | 33 | 6,9 | PZD-2 | • | 60289 | 1.000 | VARIANTA | 5.000 |
| 40 | | 38 | 6,9 | PZD-2 | • | 60313 | 200 | SKV | 4.000 |
| 40 | | 38 | 6,9 | PZD-2 | • | 60314 | 500 | VARIANTA | 5.000 |



Uitvoering: rondkop
Aandrijving: Pozi-Drive
Draadtype: variabele voldraad
Materiaal: koolstofstaal

Oppervlakte: verzinkt blauw, A3K **CHROME (VI) FREE +**

Kleurcode op het
HECO-etiket

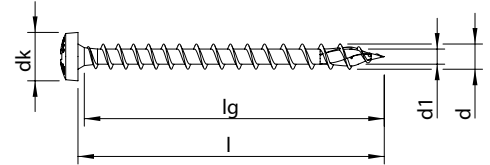

| Afmeting d x l [mm] | Draadlengte lg [mm] | Kopdiameter dk [mm] | Aandrijving | ETA | Artikelnummer | Aantal per verpakking [st.] | Type verpakking | Aantal per om- verpakking [st.] |
|------------------------|------------------------|------------------------|-------------|-------------------------|-------------------------|--------------------------------|--------------------|------------------------------------|
| 4,0 | 12 | 10 | 7,9 | PZD-2 | 60356 | 200 | SKV | 4.800 |
| | 12 | 10 | 7,9 | PZD-2 | 60357 | 1.000 | VARIANTA | 10.000 |
| | 15 | 13 | 7,9 | PZD-2 | 60366 | 200 | SKV | 4.800 |
| | 15 | 13 | 7,9 | PZD-2 | 60367 | 1.000 | VARIANTA | 10.000 |
| | 16 | 14 | 7,9 | PZD-2 | 60377 | 200 | SKV | 4.800 |
| | 16 | 14 | 7,9 | PZD-2 | 60378 | 1.000 | VARIANTA | 10.000 |
| | 20 | 18 | 7,9 | PZD-2 | • 60394 | 200 | SKV | 4.800 |
| | 20 | 18 | 7,9 | PZD-2 | • 60395 | 1.000 | VARIANTA | 10.000 |
| | 25 | 23 | 7,9 | PZD-2 | • 60416 | 200 | SKV | 4.000 |
| | 25 | 23 | 7,9 | PZD-2 | • 60417 | 1.000 | VARIANTA | 5.000 |
| | 30 | 28 | 7,9 | PZD-2 | • 60438 | 200 | SKV | 4.000 |
| | 30 | 28 | 7,9 | PZD-2 | • 60439 | 500 | VARIANTA | 5.000 |
| | 35 | 33 | 7,9 | PZD-2 | • 60462 | 200 | SKV | 4.000 |
| | 35 | 33 | 7,9 | PZD-2 | • 60463 | 500 | VARIANTA | 5.000 |
| | 40 | 38 | 7,9 | PZD-2 | • 60491 | 200 | SKV | 4.000 |
| | 40 | 38 | 7,9 | PZD-2 | • 60492 | 500 | VARIANTA | 5.000 |
| | 45 | 43 | 7,9 | PZD-2 | • 60513 | 200 | SKV | 4.000 |
| | 45 | 43 | 7,9 | PZD-2 | • 60514 | 500 | VARIANTA | 5.000 |
| | 50 | 48 | 7,9 | PZD-2 | • 60540 | 200 | SKV | 4.000 |
| 50 | 48 | 7,9 | PZD-2 | • 60541 | 500 | VARIANTA | 5.000 | |
| 60 | 58 | 7,9 | PZD-2 | • 60563 | 200 | VARIANTA | 2.000 | |

Uitvoering: rondkop

Aandrijving: Pozi-Drive

Draadtype: variabele voldraad

Materiaal: koolstofstaal

Oppervlakte: verzinkt blauw, A3K **CHROME (VI) FREE +**

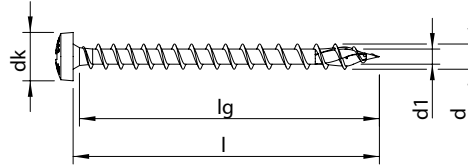

| Afmeting d x l [mm] | Draadlengte lg [mm] | Kopdiameter dk [mm] | Aandrijving | ETA | Artikelnummer | Aantal per verpakking [st.] | Type verpakking | Aantal per omverpakking [st.] |
|---------------------|---------------------|---------------------|-------------|-------|-------------------------|-----------------------------|-----------------|-------------------------------|
| 4,5 | 15 | 12 | 8,9 | PZD-2 | 60579 | 200 | SKV | 4.800 |
| | 15 | 12 | 8,9 | PZD-2 | 60580 | 500 | VARIANTA | 5.000 |
| | 16 | 13 | 8,9 | PZD-2 | 60587 | 200 | SKV | 4.800 |
| | 16 | 13 | 8,9 | PZD-2 | 60588 | 500 | VARIANTA | 5.000 |
| | 20 | 17 | 8,9 | PZD-2 | 60603 | 200 | SKV | 4.800 |
| | 20 | 17 | 8,9 | PZD-2 | 60604 | 500 | VARIANTA | 5.000 |
| | 25 | 22 | 8,9 | PZD-2 | • 60621 | 200 | SKV | 4.000 |
| | 25 | 22 | 8,9 | PZD-2 | • 60622 | 500 | VARIANTA | 5.000 |
| | 30 | 27 | 8,9 | PZD-2 | • 60643 | 200 | SKV | 4.000 |
| | 30 | 27 | 8,9 | PZD-2 | • 60644 | 500 | VARIANTA | 5.000 |
| | 35 | 32 | 8,9 | PZD-2 | • 60664 | 200 | SKV | 4.000 |
| | 35 | 32 | 8,9 | PZD-2 | • 60665 | 500 | VARIANTA | 5.000 |
| | 40 | 37 | 8,9 | PZD-2 | • 60688 | 200 | SKV | 4.000 |
| | 40 | 37 | 8,9 | PZD-2 | • 60689 | 500 | VARIANTA | 5.000 |
| | 45 | 42 | 8,9 | PZD-2 | • 60712 | 200 | SKV | 4.000 |
| | 45 | 42 | 8,9 | PZD-2 | • 60713 | 500 | VARIANTA | 2.500 |
| | 50 | 47 | 8,9 | PZD-2 | • 60736 | 200 | VARIANTA | 2.000 |
| | 60 | 57 | 8,9 | PZD-2 | • 60763 | 200 | VARIANTA | 2.000 |



Uitvoering: rondkop

Aandrijving: Pozi-Drive

Draadtype: variabele voldraad

Materiaal: koolstofstaal

Oppervlakte: verzinkt blauw, A3K **CHROME (VI) FREE +**

Kleurcode op het
HECO-etiket

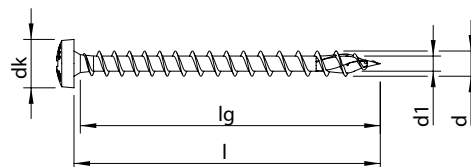

| Afmeting d x l [mm] | Draadlengte lg [mm] | Kopdiameter dk [mm] | Aandrijving | ETA | Artikelnummer | Aantal per verpakking [st.] | Type verpakking | Aantal per om- verpakking [st.] |
|------------------------|------------------------|------------------------|-------------|-------|-------------------------|--------------------------------|--------------------|------------------------------------|
| 5,0 | 16 | 13 | 9,6 | PZD-2 | 60797 | 200 | SKV | 4.000 |
| | 16 | 13 | 9,6 | PZD-2 | 60798 | 500 | VARIANTA | 5.000 |
| | 20 | 17 | 9,6 | PZD-2 | 60809 | 200 | SKV | 4.000 |
| | 20 | 17 | 9,6 | PZD-2 | 60810 | 500 | VARIANTA | 5.000 |
| | 25 | 22 | 9,6 | PZD-2 | • 60823 | 200 | SKV | 4.000 |
| | 25 | 22 | 9,6 | PZD-2 | • 60824 | 500 | VARIANTA | 5.000 |
| | 30 | 27 | 9,6 | PZD-2 | • 60842 | 200 | SKV | 4.000 |
| | 30 | 27 | 9,6 | PZD-2 | • 60843 | 500 | VARIANTA | 5.000 |
| | 35 | 32 | 9,6 | PZD-2 | • 60860 | 200 | SKV | 4.000 |
| | 35 | 32 | 9,6 | PZD-2 | • 60861 | 500 | VARIANTA | 2.500 |
| | 40 | 37 | 9,6 | PZD-2 | • 60880 | 200 | VARIANTA | 2.000 |
| | 50 | 47 | 9,6 | PZD-2 | • 60909 | 200 | VARIANTA | 2.000 |
| | 60 | 57 | 9,6 | PZD-2 | • 60933 | 200 | VARIANTA | 2.000 |
| | 70 | 67 | 9,6 | PZD-2 | • 60949 | 200 | VARIANTA | 2.000 |
| | 80 | 77 | 9,6 | PZD-2 | • 60962 | 200 | VARIANTA | 2.000 |

Uitvoering: rondkop

Aandrijving: Pozi-Drive

Draadtype: variabele voldraad

Materiaal: koolstofstaal

Oppervlakte: verzinkt blauw, A3K **CHROME (VI) FREE +**

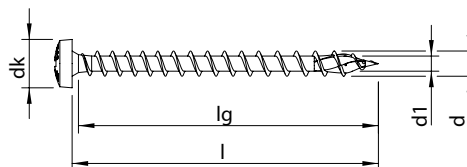

| Afmeting d x l [mm] | Draadlengte lg [mm] | Kopdiameter dk [mm] | Aandrijving | ETA | Artikelnummer | Aantal per verpakking [st.] | Type verpakking | Aantal per omverpakking [st.] |
|---------------------|---------------------|---------------------|-------------|-----|-----------------------|-----------------------------|-----------------|-------------------------------|
| 6,0 | 30 | 26 | PZD-3 | • | 60998 | 200 | VARIANTA | 2.000 |
| + | 35 | 31 | PZD-3 | • | 61003 | 200 | VARIANTA | 2.000 |
| | 40 | 36 | PZD-3 | • | 61010 | 200 | VARIANTA | 2.000 |
| | 50 | 46 | PZD-3 | • | 61036 | 200 | VARIANTA | 2.000 |
| | 60 | 56 | PZD-3 | • | 61059 | 200 | VARIANTA | 2.000 |
| | 70 | 66 | PZD-3 | • | 61079 | 200 | VARIANTA | 1.000 |
| | 80 | 76 | PZD-3 | • | 61092 | 100 | VARIANTA | 1.000 |



| | |
|---------------------|--------------------------|
| Uitvoering: | rondkop |
| Aandrijving: | Pozi-Drive |
| Draadtype: | variabele voldraad |
| Materiaal: | roestvaststaal A2 1.4567 |
| Oppervlakte: | blank, glijcoating |

Kleurcode op het
HECO-etiket

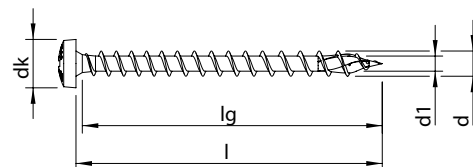

| Afmeting d x l [mm] | Draadlengte lg [mm] | Kopdiameter dk [mm] | Aandrijving | ETA | Artikelnummer | Aantal per verpakking [st.] | Type verpakking | Aantal per om- verpakking [st.] |
|------------------------|------------------------|------------------------|-------------|-------|-----------------------|--------------------------------|--------------------|------------------------------------|
| 3,0 + | 20 | 18 | 5,9 | PZD-1 | 61620 | 200 | SKV | 4.800 |
| | 30 | 28 | 5,9 | PZD-1 | 61627 | 200 | SKV | 4.000 |
| 3,5 + | 20 | 18 | 6,9 | PZD-2 | 61633 | 200 | SKV | 4.800 |
| | 30 | 28 | 6,9 | PZD-2 | 61639 | 200 | SKV | 4.800 |
| 4,0 + | 20 | 18 | 7,9 | PZD-2 | 61659 | 200 | SKV | 4.800 |
| | 25 | 23 | 7,9 | PZD-2 | 61664 | 200 | SKV | 4.000 |
| | 30 | 28 | 7,9 | PZD-2 | 61670 | 200 | SKV | 4.000 |
| | 35 | 33 | 7,9 | PZD-2 | 61675 | 200 | SKV | 4.000 |
| | 40 | 38 | 7,9 | PZD-2 | 61679 | 200 | SKV | 4.000 |
| | 45 | 43 | 7,9 | PZD-2 | 61683 | 200 | SKV | 4.000 |
| | 50 | 48 | 7,9 | PZD-2 | 61687 | 200 | SKV | 4.000 |
| 5,0 + | 25 | 22 | 9,6 | PZD-2 | 61729 | 200 | SKV | 4.000 |
| | 30 | 27 | 9,6 | PZD-2 | 61732 | 200 | SKV | 4.000 |
| | 40 | 37 | 9,6 | PZD-2 | 61747 | 200 | SKV | 4.000 |
| | 50 | 47 | 9,6 | PZD-2 | 61764 | 200 | VARIANTA | 2.000 |



Uitvoering: verzonken lenskop met freesholtes

Aandrijving: HECO-Drive *





Draadtype: variabele voldraad

Materiaal: roestvaststaal A2 1.4567

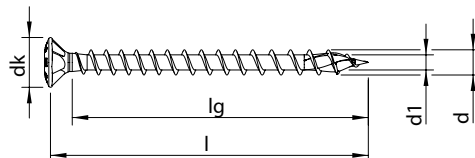
Oppervlakte: blank, glijcoating

Kleurcode op het
HECO-etiket



| Afmeting d x l [mm] | Draadlengte lg [mm] | Kopdiameter dk [mm] | Aandrijving | ETA | Artikelnummer | Aantal per verpakking [st.] | Type verpakking | Aantal per om- verpakking [st.] | |
|---|------------------------|------------------------|-------------|-------|---------------|--------------------------------|--------------------|------------------------------------|-------|
| 3,5  | 20 | 16 | 7,3 | HD-20 | • | 61997 | 200 | SKV | 4.800 |
| | 25 | 21 | 7,3 | HD-20 | • | 61998 | 200 | SKV | 4.800 |
| | 30 | 26 | 7,3 | HD-20 | • | 61999 | 200 | SKV | 4.800 |
| | 35 | 31 | 7,3 | HD-20 | • | 62000 | 200 | SKV | 4.000 |
| | 40 | 36 | 7,3 | HD-20 | • | 62001 | 200 | SKV | 4.000 |
| 4,0  | 20 | 15 | 7,9 | HD-20 | • | 62002 | 200 | SKV | 4.800 |
| | 25 | 20 | 7,9 | HD-20 | • | 62003 | 200 | SKV | 4.800 |
| | 30 | 25 | 7,9 | HD-20 | • | 62004 | 200 | SKV | 4.800 |
| | 35 | 30 | 7,9 | HD-20 | • | 62005 | 200 | SKV | 4.000 |
| | 40 | 35 | 7,9 | HD-20 | • | 62006 | 200 | SKV | 4.000 |
| 4,5  | 40 | 35 | 8,9 | HD-20 | • | 62008 | 200 | SKV | 4.000 |
| | 50 | 45 | 8,9 | HD-20 | • | 62010 | 200 | VARIANTA | 2.000 |
| 5,0  | 50 | 44 | 9,6 | HD-20 | • | 62011 | 200 | VARIANTA | 2.000 |
| | 60 | 54 | 9,6 | HD-20 | • | 62012 | 200 | VARIANTA | 2.000 |

* Alle schroeven met HECO-Drive zijn 100% compatibel met conventionele TX-bits.
Het GripFit-effect is alleen gegarandeerd bij gebruik met bijpassende HECO-Drive-bits.

Uitvoering: verzonken lenskop met freesholtes

Aandrijving: Pozi-Drive

Draadtype: variabele voldraad

Materiaal: roestvaststaal A2 1.4567

Oppervlakte: blank, glijcoating

Kleurcode op het HECO-etiket

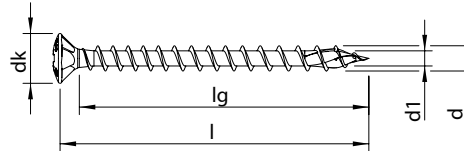

| Afmeting d x l [mm] | Draadlengte lg [mm] | Kopdiameter dk [mm] | Aandrijving | ETA | Artikelnummer | Aantal per verpakking [st.] | Type verpakking | Aantal per omverpakking [st.] | |
|---------------------|---------------------|---------------------|-------------|-------|---------------|-----------------------------|-----------------|-------------------------------|-------|
| 3,5 + | 20 | 16 | 7,3 | PZD-2 | • | 61632 | 200 | SKV | 4.800 |
| | 25 | 21 | 7,3 | PZD-2 | • | 61635 | 200 | SKV | 4.800 |
| | 30 | 26 | 7,3 | PZD-2 | • | 61638 | 200 | SKV | 4.800 |
| | 35 | 31 | 7,3 | PZD-2 | • | 61643 | 200 | SKV | 4.000 |
| | 40 | 36 | 7,3 | PZD-2 | • | 61648 | 200 | SKV | 4.000 |
| 4,0 + | 20 | 15 | 7,9 | PZD-2 | • | 61658 | 200 | SKV | 4.800 |
| | 25 | 20 | 7,9 | PZD-2 | • | 61663 | 200 | SKV | 4.800 |
| | 30 | 25 | 7,9 | PZD-2 | • | 61669 | 200 | SKV | 4.800 |
| | 35 | 30 | 7,9 | PZD-2 | • | 61674 | 200 | SKV | 4.000 |
| | 40 | 35 | 7,9 | PZD-2 | • | 61678 | 200 | SKV | 4.000 |
| 4,5 + | 50 | 45 | 7,9 | PZD-2 | • | 61686 | 200 | SKV | 4.000 |
| | 40 | 35 | 8,9 | PZD-2 | • | 61700 | 200 | SKV | 4.000 |
| 5,0 + | 50 | 45 | 8,9 | PZD-2 | • | 61710 | 200 | VARIANTA | 2.000 |
| | 50 | 44 | 9,6 | PZD-2 | • | 61763 | 200 | VARIANTA | 2.000 |
| 5,0 + | 60 | 54 | 9,6 | PZD-2 | • | 61776 | 200 | VARIANTA | 2.000 |



Uitvoering: achterwandschroef, tellerkop

Aandrijving: T-Drive

Draadtype: variabele voldraad

Materiaal: koolstofstaal

Oppervlakte: verzinkt blauw, A3K **CHROME (VI) FREE +**

Kleurcode op het HECO-etiket

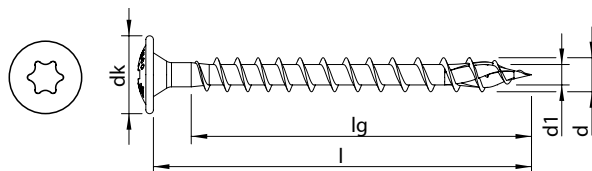

| Afmeting d x l [mm] | Draadlengte lg [mm] | Kopdiameter dk [mm] | Aandrijving | ETA | Artikelnummer | Aantal per verpakking [st.] | Type verpakking | Aantal per omverpakking [st.] |
|---------------------|---------------------|---------------------|-------------|-----------------------|-----------------------|-----------------------------|-----------------|-------------------------------|
| 3,0 | 20 | 18 | 8,0 | T-10 | 61959 | 1.000 | VARIANTA | 10.000 |
| | 25 | 23 | 8,0 | T-10 | 61960 | 1.000 | VARIANTA | 10.000 |
| | 30 | 28 | 8,0 | T-10 | 61961 | 1.000 | VARIANTA | 10.000 |
| | 35 | 33 | 8,0 | T-10 | 61962 | 500 | VARIANTA | 5.000 |
| 3,5 | 20 | 17 | 8,2 | T-20 | 61963 | 1.000 | VARIANTA | 10.000 |
| | 25 | 22 | 8,2 | T-20 | 61964 | 1.000 | VARIANTA | 10.000 |
| | 30 | 27 | 8,2 | T-20 | 61965 | 500 | VARIANTA | 5.000 |
| | 35 | 32 | 8,2 | T-20 | 61966 | 500 | VARIANTA | 5.000 |
| 4,0 | 25 | 22 | 9,2 | T-20 | 61967 | 500 | VARIANTA | 5.000 |
| | 30 | 27 | 9,2 | T-20 | 61968 | 500 | VARIANTA | 5.000 |
| | 35 | 32 | 9,2 | T-20 | 61969 | 500 | VARIANTA | 5.000 |
| | 40 | 37 | 9,2 | T-20 | 61970 | 500 | VARIANTA | 5.000 |
| 4,5 | 25 | 22 | 10,3 | T-20 | 61971 | 1.000 | VARIANTA | 5.000 |
| | 30 | 27 | 10,3 | T-20 | 61972 | 500 | VARIANTA | 5.000 |
| | 35 | 32 | 10,3 | T-20 | 61973 | 500 | VARIANTA | 5.000 |
| | 40 | 37 | 10,3 | T-20 | 61974 | 200 | VARIANTA | 2.000 |
| | 45 | 42 | 10,3 | T-20 | 61975 | 200 | VARIANTA | 2.000 |
| 50 | 47 | 10,3 | T-20 | 61976 | 200 | VARIANTA | 2.000 | |
| 5,0* | 60 | 56 | 11,8 | T-20 | 61977 | 200 | VARIANTA | 2.000 |

* Kleurcodering HD-/T-20-bit =

Uitvoering: achterwandschroef, tellerkop

Aandrijving: Pozi-Drive

Draadtype: variabele voldraad

Materiaal: koolstofstaal

Oppervlakte: verzinkt blauw, A3K **CHROME (VI) FREE +**

Kleurcode op het HECO-etiket

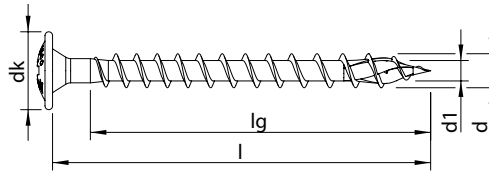

| Afmeting d x l [mm] | Draadlengte lg [mm] | Kopdiameter dk [mm] | Aandrijving | ETA | Artikelnummer | Aantal per verpakking [st.] | Type verpakking | Aantal per omverpakking [st.] |
|---------------------|---------------------|---------------------|-------------|-------|-----------------------|-----------------------------|-----------------|-------------------------------|
| 3,0 + | 20 | 18 | 8,0 | PZD-2 | 60076 | 1.000 | VARIANTA | 10.000 |
| | 25 | 23 | 8,0 | PZD-2 | 60094 | 1.000 | VARIANTA | 10.000 |
| | 30 | 28 | 8,0 | PZD-2 | 60111 | 1.000 | VARIANTA | 10.000 |
| | 35 | 33 | 8,0 | PZD-2 | 60132 | 500 | VARIANTA | 5.000 |
| 3,5 + | 20 | 17 | 8,2 | PZD-2 | 60208 | 1.000 | VARIANTA | 10.000 |
| | 25 | 22 | 8,2 | PZD-2 | 60224 | 1.000 | VARIANTA | 10.000 |
| | 30 | 27 | 8,2 | PZD-2 | 60248 | 500 | VARIANTA | 5.000 |
| | 35 | 32 | 8,2 | PZD-2 | 60269 | 500 | VARIANTA | 5.000 |
| 4,0 + | 25 | 22 | 9,2 | PZD-2 | 60398 | 500 | VARIANTA | 5.000 |
| | 30 | 27 | 9,2 | PZD-2 | 60421 | 500 | VARIANTA | 5.000 |
| | 35 | 32 | 9,2 | PZD-2 | 60445 | 500 | VARIANTA | 5.000 |
| 4,5 + | 40 | 37 | 9,2 | PZD-2 | 60466 | 500 | VARIANTA | 5.000 |
| | 25 | 22 | 10,3 | PZD-2 | 60608 | 1.000 | VARIANTA | 5.000 |
| | 30 | 27 | 10,3 | PZD-2 | 60626 | 500 | VARIANTA | 5.000 |
| | 35 | 32 | 10,3 | PZD-2 | 60648 | 500 | VARIANTA | 5.000 |
| | 40 | 37 | 10,3 | PZD-2 | 60670 | 200 | VARIANTA | 2.000 |
| 5,0* | 45 | 42 | 10,3 | PZD-2 | 60695 | 200 | VARIANTA | 2.000 |
| | 50 | 47 | 10,3 | PZD-2 | 60717 | 200 | VARIANTA | 2.000 |
| 5,0* | 60 | 56 | 11,8 | PZD-2 | 60920 | 200 | VARIANTA | 2.000 |

* Kleurcodering PZD-2-bit =



HECO-TOPIX®-plus Tellerkopschroef

Product informatie

- Hogere lastoverdracht door vergroot klemvlak van de kop
- Hoge schroefdraadspoed voor sneller inschroeven
- Dimensioneringsbewijzen via HECO-HCS of dimensioneringsservice
- Oppervlakte zonder chroom-VI
- Goedgekeurd en bewaakt product (CE-markering)



De houtbouwschroef voor de professional

MagicClose®

Gepatenteerde voldraad trekt houten onderdelen spleetvrij samen zonder voorspannen. (alleen bij voldraadschroeven met Ø 6 mm)

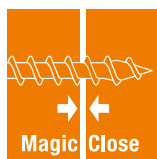

Schachtfreesribben

Maken gemakkelijk inschroeven zonder mechanische spanning mogelijk (alleen bij deeldraad)

PerfectPitch®

Optimale schroefdraadspoed voor elke schroeflengte



HECO-TOPIX-plus-punt

Maakt voorbereiden overbodig en vermindert het risico van splijten van het hout



Uitvoering: tellerkop
Aandrijving: T-Drive
Draadtype: variabele voldraad
Materiaal: koolstofstaal
Oppervlakte: verzinkt blauw, A3K **CHROME (VI) FREE +**

Kleurcode op het HECO-etiket

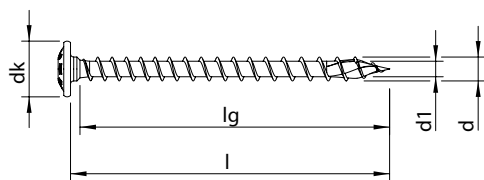
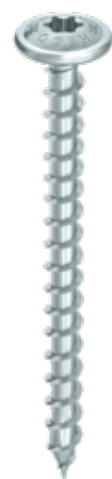

| Afmeting d x l [mm] | Draadlengte lg [mm] | Kopdiameter dk [mm] | Aandrijving | ETA | Artikelnummer | Aantal per verpakking [st.] | Type verpakking | Aantal per omverpakking [st.] |
|---------------------|---------------------|---------------------|-------------|------|-------------------------|-----------------------------|-----------------|-------------------------------|
| 6,0 | 40 | 36 | 14,0 | T-30 | • 61013 | 200 | VARIANTA | 2.000 |
| | 50 | 46 | 14,0 | T-30 | • 61039 | 200 | VARIANTA | 2.000 |
| | 60 | 56 | 14,0 | T-30 | • 61063 | 100 | VARIANTA | 1.000 |
| | 70 | 66 | 14,0 | T-30 | • 61080 | 100 | VARIANTA | 1.000 |
| | 80 | 76 | 14,0 | T-30 | • 61094 | 100 | VARIANTA | 1.000 |

Uitvoering: tellerkop
Aandrijving: T-Drive
Draadtype: voldraad
Materiaal: koolstofstaal
Oppervlakte: verzinkt blauw, A3K **CHROME (VI) FREE +**

Kleurcode op het HECO-etiket



71

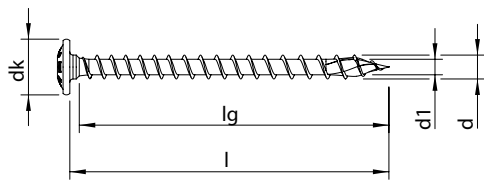
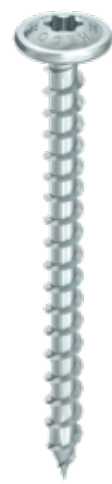

| Afmeting d x l [mm] | Draadlengte lg [mm] | Kopdiameter dk [mm] | Aandrijving | ETA | Artikelnummer | Aantal per verpakking [st.] | Type verpakking | Aantal per omverpakking [st.] |
|---------------------|---------------------|---------------------|-------------|------|-------------------------|-----------------------------|-----------------|-------------------------------|
| 8,0 | 80 | 74 | 18,0 | T-40 | • 61245 | 50 | VARIANTA | 200 |
| | 100 | 94 | 18,0 | T-40 | • 61259 | 50 | VARIANTA | 200 |
| | 120 | 114 | 18,0 | T-40 | • 61270 | 50 | VARIANTA | 200 |
| 10,0 | 80 | 73 | 22,5 | T-40 | • 61475 | 50 | VARIANTA | 200 |
| | 100 | 93 | 22,5 | T-40 | • 61483 | 50 | VARIANTA | 200 |
| | 120 | 100 | 22,5 | T-40 | • 61492 | 50 | VARIANTA | 200 |



Uitvoering: tellerkop

Aandrijving: T-Drive

Draadtype: variabele voldraad

Materiaal: roestvaststaal A2 1.4567

Oppervlakte: blank, glijcoating

Kleurcode op het HECO-etiket

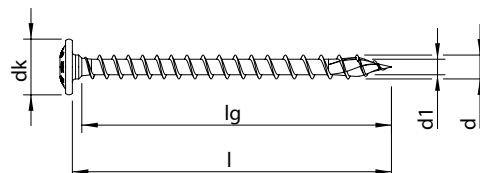

| Afmeting d x l [mm] | Draadlengte lg [mm] | Kopdiameter dk [mm] | Aandrijving | ETA | Artikelnummer | Aantal per verpakking [st.] | Type verpakking | Aantal per omverpakking [st.] | |
|---------------------|---------------------|---------------------|-------------|------|---------------|-----------------------------|-----------------|-------------------------------|-------|
| 6,0 | 40 | 36 | 14,0 | T-30 | ● | 61802 | 200 | VARIANTA | 2.000 |
| | 50 | 46 | 14,0 | T-30 | ● | 61805 | 200 | VARIANTA | 2.000 |
| | 60 | 56 | 14,0 | T-30 | ● | 61810 | 100 | VARIANTA | 1.000 |
| | 70 | 66 | 14,0 | T-30 | ● | 61815 | 100 | VARIANTA | 1.000 |
| | 80 | 76 | 14,0 | T-30 | ● | 61820 | 100 | VARIANTA | 1.000 |



Uitvoering: tellerkop

Aandrijving: T-Drive

Draadtype: voldraad

Materiaal: roestvaststaal A2 1.4567

Oppervlakte: blank, glijcoating

Kleurcode op het HECO-etiket

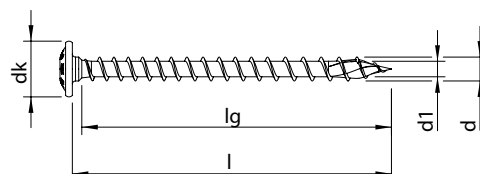

| Afmeting d x l [mm] | Draadlengte lg [mm] | Kopdiameter dk [mm] | Aandrijving | ETA | Artikelnummer | Aantal per verpakking [st.] | Type verpakking | Aantal per omverpakking [st.] | |
|---------------------|---------------------|---------------------|-------------|------|---------------|-----------------------------|-----------------|-------------------------------|-----|
| 8,0 | 40 | 34 | 18,0 | T-40 | ● | 61844 | 50 | VARIANTA | 200 |
| | 50 | 44 | 18,0 | T-40 | ● | 61845 | 50 | VARIANTA | 200 |
| | 60 | 54 | 18,0 | T-40 | ● | 61846 | 50 | VARIANTA | 200 |
| | 80 | 74 | 18,0 | T-40 | ● | 61849 | 50 | VARIANTA | 200 |
| | 100 | 94 | 18,0 | T-40 | ● | 61853 | 50 | VARIANTA | 200 |
| | 120 | 114 | 18,0 | T-40 | ● | 61860 | 50 | VARIANTA | 200 |

Uitvoering: tellerkop

Aandrijving: T-Drive

Draadtype: deeldraad

Materiaal: koolstofstaal

Oppervlakte: verzinkt blauw, A3K **CHROME (VI) FREE +**

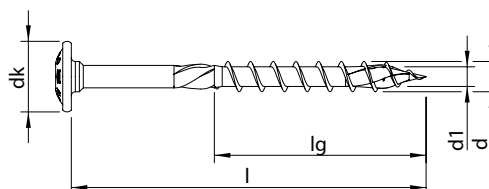

| Afmeting d x l [mm] | Draadlengte lg [mm] | Kopdiameter dk [mm] | Aandrijving | ETA | Artikelnummer | Aantal per verpakking [st.] | Type verpakking | Aantal per omverpakking [st.] |
|---------------------|---------------------|---------------------|-------------|--------------|---------------|-----------------------------|-----------------|-------------------------------|
| 6,0 | 100 | 60 | 14,0 | T-30/T-25* | 61117/62278* | NIEUW 100 | VARIANTA | 1.000 |
| | 120 | 72 | 14,0 | T-30/T-25* | 61137/62279* | NIEUW 100 | VARIANTA | 1.000 |
| | 140 | 72 | 14,0 | T-30/T-25* | 61151/62280* | NIEUW 100 | VARIANTA | 800 |
| | 160 | 72 | 14,0 | T-30/T-25* | 61167/62281* | NIEUW 100 | VARIANTA | 400 |
| | 180 | 72 | 14,0 | T-30/T-25* | 61176/62282* | NIEUW 100 | VARIANTA | 400 |
| | 200 | 72 | 14,0 | T-30/T-25* | 61185/62283* | NIEUW 100 | VARIANTA | 400 |
| | 220 | 72 | 14,0 | T-30/T-25* | 61192/62284* | NIEUW 100 | VARIANTA | 400 |
| | 240 | 72 | 14,0 | T-30/T-25* | 61199/62285* | NIEUW 100 | VARIANTA | 400 |
| | 260 | 72 | 14,0 | T-30/T-25* | 61206/62286* | NIEUW 100 | VARIANTA | 400 |
| | 280 | 72 | 14,0 | T-30/T-25* | 61213/62287* | NIEUW 100 | VARIANTA | 400 |
| 300 | 72 | 14,0 | T-30/T-25* | 61220/62288* | NIEUW 100 | VARIANTA | 200 | |
| 8,0 | 120 | 72 | 18,0 | T-40 | 61272 | 50 | VARIANTA | 200 |
| | 140 | 100 | 18,0 | T-40 | 61280 | 50 | VARIANTA | 200 |
| | 160 | 100 | 18,0 | T-40 | 61294 | 50 | VARIANTA | 200 |
| | 180 | 100 | 18,0 | T-40 | 61306 | 50 | VARIANTA | 200 |
| | 200 | 100 | 18,0 | T-40 | 61319 | 50 | VARIANTA | 200 |
| | 220 | 100 | 18,0 | T-40 | 61330 | 50 | VARIANTA | 200 |
| | 240 | 100 | 18,0 | T-40 | 61341 | 50 | VARIANTA | 200 |
| | 260 | 100 | 18,0 | T-40 | 61353 | 50 | VARIANTA | 200 |
| | 280 | 100 | 18,0 | T-40 | 61367 | 50 | VARIANTA | 200 |
| | 300 | 100 | 18,0 | T-40 | 61379 | 50 | VARIANTA | 200 |
| | 320 | 100 | 18,0 | T-40 | 61391 | 50 | VARIANTA | 200 |
| | 340 | 100 | 18,0 | T-40 | 61403 | 50 | VARIANTA | 100 |
| | 360 | 100 | 18,0 | T-40 | 61413 | 50 | VARIANTA | 100 |
| | 380 | 100 | 18,0 | T-40 | 61423 | 50 | VARIANTA | 100 |
| | 400 | 100 | 18,0 | T-40 | 61432 | 50 | VARIANTA | 100 |
| | 420 | 100 | 18,0 | T-40 | 61438 | 50 | VARIANTA | 100 |
| 460 | 100 | 18,0 | T-40 | 61443 | 50 | VARIANTA | 100 | |
| 500 | 100 | 18,0 | T-40 | 61447 | 50 | VARIANTA | 100 | |

* Alternatieve houtbouwvariant met aandrijving T-25



Uitvoering: tellerkop

Aandrijving: T-Drive

Draadtype: deeldraad

Materiaal: koolstofstaal

Oppervlakte: verzinkt blauw, A3K **CHROME (VI) FREE +**

Kleurcode op het
HECO-etiket

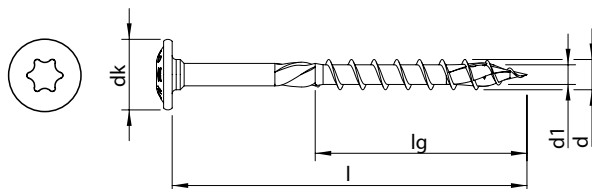

| Afmeting d x l [mm] | Draadlengte lg [mm] | Kopdiameter dk [mm] | Aandrijving | ETA | Artikelnummer | Aantal per verpakking [st.] | Type verpakking | Aantal per om- verpakking [st.] | |
|------------------------|------------------------|------------------------|-------------|------|---------------|--------------------------------|--------------------|------------------------------------|-----|
| 10,0 ★ | 140 | 84 | 22,5 | T-40 | ● | 61501 | 50 | VARIANTA | 200 |
| | 160 | 100 | 22,5 | T-40 | ● | 61512 | 50 | VARIANTA | 200 |
| | 180 | 100 | 22,5 | T-40 | ● | 61518 | 50 | VARIANTA | 200 |
| | 200 | 100 | 22,5 | T-40 | ● | 61527 | 50 | VARIANTA | 200 |
| | 220 | 100 | 22,5 | T-40 | ● | 61535 | 50 | VARIANTA | 200 |
| | 240 | 100 | 22,5 | T-40 | ● | 61543 | 50 | VARIANTA | 100 |
| | 260 | 100 | 22,5 | T-40 | ● | 61552 | 50 | VARIANTA | 100 |
| | 280 | 100 | 22,5 | T-40 | ● | 61562 | 50 | VARIANTA | 100 |
| | 300 | 100 | 22,5 | T-40 | ● | 61572 | 50 | VARIANTA | 100 |
| | 320 | 100 | 22,5 | T-40 | ● | 61580 | 50 | VARIANTA | 100 |
| | 340 | 100 | 22,5 | T-40 | ● | 61588 | 50 | VARIANTA | 100 |
| | 360 | 100 | 22,5 | T-40 | ● | 61592 | 50 | VARIANTA | 100 |
| | 380 | 100 | 22,5 | T-40 | ● | 61598 | 50 | VARIANTA | 100 |
| | 400 | 100 | 22,5 | T-40 | ● | 61603 | 50 | VARIANTA | 100 |

Uitvoering: tellerkop

Aandrijving: T-Drive

Draadtype: deeldraad

Materiaal: roestvaststaal A2 1.4567

Oppervlakte: blank, glijcoating



Kleurcode op het HECO-etiket

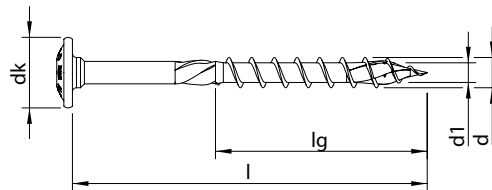

| Afmeting d x l [mm] | Draadlengte lg [mm] | Kopdiameter dk [mm] | Aandrijving | ETA | Artikelnummer | Aantal per verpakking [st.] | Type verpakking | Aantal per omverpakking [st.] | |
|---------------------|---------------------|---------------------|-------------|------|---------------|-----------------------------|-----------------|-------------------------------|-------|
| 6,0 | 100 | 60 | 14,0 | T-30 | ● | 61828 | 100 | VARIANTA | 1.000 |
| | 120 | 72 | 14,0 | T-30 | ● | 61836 | 100 | VARIANTA | 500 |
| 8,0 | 140 | 84 | 18,0 | T-40 | ● | 61863 | 50 | VARIANTA | 200 |
| | 160 | 100 | 18,0 | T-40 | ● | 61868 | 50 | VARIANTA | 200 |
| | 180 | 100 | 18,0 | T-40 | ● | 61872 | 50 | VARIANTA | 200 |
| | 200 | 100 | 18,0 | T-40 | ● | 61876 | 50 | VARIANTA | 200 |
| | 220 | 100 | 18,0 | T-40 | ● | 61880 | 50 | VARIANTA | 200 |
| | 240 | 100 | 18,0 | T-40 | ● | 61887 | 50 | VARIANTA | 200 |
| | 260 | 100 | 18,0 | T-40 | ● | 61891 | 50 | VARIANTA | 200 |
| | 280 | 100 | 18,0 | T-40 | ● | 61896 | 50 | VARIANTA | 200 |
| | 300 | 100 | 18,0 | T-40 | ● | 61902 | 50 | VARIANTA | 200 |



Uitvoering: tellerkop XL

Aandrijving: T-Drive

Draadtype: deeldraad

Materiaal: koolstofstaal

Oppervlakte: verzinkt blauw, A3K **CHROME (VI) FREE +**

Kleurcode op het
HECO-etiket

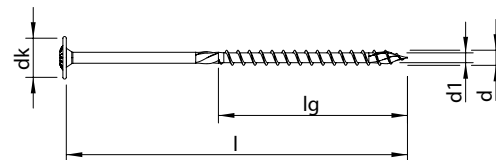

| Afmeting d x l [mm] | Draadlengte lg [mm] | Kopdiameter dk [mm] | Aandrijving | ETA | Artikelnummer | Aantal per verpakking [st.] | Type verpakking | Aantal per om- verpakking [st.] | |
|---|------------------------|------------------------|-------------|------|---------------|--------------------------------|--------------------|------------------------------------|-----|
| 8,0  | 160 | 100 | 22,5 | T-40 | ● | 61293 | 50 | VARIANTA | 200 |
| | 180 | 100 | 22,5 | T-40 | ● | 61305 | 50 | VARIANTA | 200 |
| | 200 | 100 | 22,5 | T-40 | ● | 61317 | 50 | VARIANTA | 200 |
| | 220 | 100 | 22,5 | T-40 | ● | 61329 | 50 | VARIANTA | 200 |
| | 240 | 100 | 22,5 | T-40 | ● | 61340 | 50 | VARIANTA | 200 |
| | 260 | 100 | 22,5 | T-40 | ● | 61351 | 50 | VARIANTA | 200 |
| | 280 | 100 | 22,5 | T-40 | ● | 61365 | 50 | VARIANTA | 200 |
| | 300 | 100 | 22,5 | T-40 | ● | 61378 | 50 | VARIANTA | 200 |
| | 320 | 100 | 22,5 | T-40 | ● | 61389 | 50 | VARIANTA | 100 |
| | 340 | 100 | 22,5 | T-40 | ● | 61402 | 50 | VARIANTA | 100 |
| | 360 | 100 | 22,5 | T-40 | ● | 61412 | 50 | VARIANTA | 100 |
| | 380 | 100 | 22,5 | T-40 | ● | 61422 | 50 | VARIANTA | 100 |
| | 400 | 100 | 22,5 | T-40 | ● | 61431 | 50 | VARIANTA | 100 |



Uitvoering: combizeskantkop

Aandrijving: zeskantkop + T-Drive

Draadtype: voldraad

Materiaal: koolstofstaal

Oppervlakte: verzinkt blauw, A3K **CHROME (VI) FREE +**

Kleurcode op het
HECO-etiket

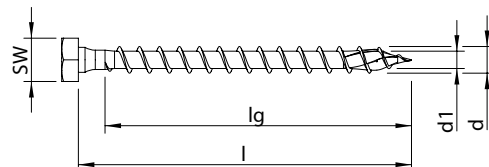

| Afmeting d x l [mm] | Draadlengte lg [mm] | Kopdiameter dk [mm] | Aandrijving | ETA | Artikelnummer | Aantal per verpakking [st.] | Type verpakking | Aantal per om- verpakking [st.] | |
|------------------------|------------------------|------------------------|-------------|------------|---------------|--------------------------------|--------------------|------------------------------------|-----|
| 8,0 ★ | 50 | 42 | 13,0 | SW-13/T-40 | ● | 61232 | 100 | VARIANTA | 400 |
| | 60 | 52 | 13,0 | SW-13/T-40 | ● | 61237 | 100 | VARIANTA | 400 |
| | 70 | 62 | 13,0 | SW-13/T-40 | ● | 61240 | 50 | VARIANTA | 200 |
| | 80 | 72 | 13,0 | SW-13/T-40 | ● | 61248 | 50 | VARIANTA | 200 |
| | 100 | 92 | 13,0 | SW-13/T-40 | ● | 61262 | 50 | VARIANTA | 200 |
| 10,0 ★ | 60 | 50 | 15,0 | SW-15/T-40 | ● | 61470 | 50 | VARIANTA | 200 |
| | 70 | 60 | 15,0 | SW-15/T-40 | ● | 61471 | 50 | VARIANTA | 200 |
| | 80 | 70 | 15,0 | SW-15/T-40 | ● | 61478 | 50 | VARIANTA | 200 |
| | 100 | 90 | 15,0 | SW-15/T-40 | ● | 61486 | 50 | VARIANTA | 200 |

Uitvoering: combizeskantkop

Aandrijving: zeskantkop + T-Drive

Draadtype: deeldraad



Materiaal: koolstofstaal

Oppervlakte: verzinkt blauw, A3K **CHROME (VI) FREE +**

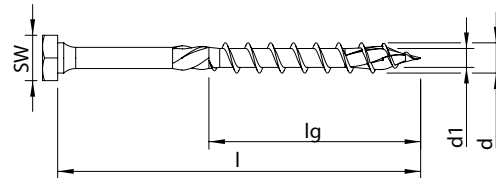

Kleurcode op het HECO-etiket



| Afmeting d x l [mm] | Draadlengte lg [mm] | Kopdiameter dk [mm] | Aandrijving | ETA | Artikelnummer | Aantal per verpakking [st.] | Type verpakking | Aantal per omverpakking [st.] | |
|---|---------------------|---------------------|-------------|------------|---------------|-----------------------------|-----------------|-------------------------------|-----|
| 8,0 | 120 | 72 | 13,0 | SW-13/T-40 | ● | 61273 | 50 | VARIANTA | 200 |
|  | 140 | 84 | 13,0 | SW-13/T-40 | ● | 61284 | 50 | VARIANTA | 200 |
| 10,0 | 120 | 72 | 15,0 | SW-15/T-40 | ● | 61497 | 50 | VARIANTA | 200 |
|  | 140 | 84 | 15,0 | SW-15/T-40 | ● | 61504 | 50 | VARIANTA | 200 |



Uitvoering: cilinderkop

Aandrijving: T-Drive

Draadtype: voldraad

Materiaal: koolstofstaal

Oppervlakte: verzinkt blauw, A3K **CHROME (VI) FREE +**

Kleurcode op het HECO-etiket

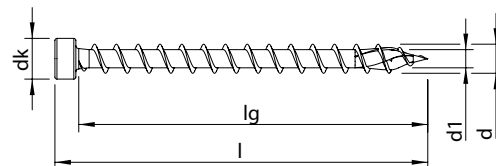

| Afmeting d x l [mm] | Draadlengte lg [mm] | Kopdiameter dk [mm] | Aandrijving | ETA | Artikelnummer | Aantal per verpakking [st.] | Type verpakking | Aantal per omverpakking [st.] | |
|---------------------|---------------------|---------------------|-------------|------|------------------------------------|------------------------------------|-----------------|-------------------------------|-------|
| 6,0 ★ | 120 | 114 | 9,0 | T-30 | ● | 61953 | 100 | VARIANTA | 1.000 |
| | 140 | 134 | 9,0 | T-30 | ● | 61952 | 100 | VARIANTA | 500 |
| | 160 | 154 | 9,0 | T-30 | ● | 61951 | 100 | VARIANTA | 800 |
| | 180 | 174 | 9,0 | T-30 | ● | 61950 | 100 | VARIANTA | 400 |
| | 200 | 194 | 9,0 | T-30 | ● | 61949 | 100 | VARIANTA | 400 |
| 8,0 ★ | 120 | 112 | 12,0 | T-40 | ● | 61928 | 100 | VARIANTA | 400 |
| | 160 | 152 | 12,0 | T-40 | ● | 61929 | 100 | VARIANTA | 400 |
| | 180 | 172 | 12,0 | T-40 | ● | 61930 | 100 | VARIANTA | 200 |
| | 200 | 192 | 12,0 | T-40 | ● | 61931 | 100 | VARIANTA | 200 |
| | 220 | 212 | 12,0 | T-40 | ● | 61932 | 50 | VARIANTA | 200 |
| | 240 | 232 | 12,0 | T-40 | ● | 61933 | 50 | VARIANTA | 200 |
| | 260 | 252 | 12,0 | T-40 | ● | 61934 | 50 | VARIANTA | 200 |
| | 280 | 272 | 12,0 | T-40 | ● | 61935 | 50 | VARIANTA | 200 |
| | 300 | 292 | 12,0 | T-40 | ● | 61936 | 50 | VARIANTA | 200 |
| | 340 | 332 | 12,0 | T-40 | ● | 61937 | 50 | VARIANTA | 200 |
| | 380 | 372 | 12,0 | T-40 | ● | 61938 | 50 | VARIANTA | 100 |
| | 400 | 360 | 10,0 | T-40 | ● | 62078 NIEUW | 50 | VARIANTA | 200 |
| | 450 | 410 | 10,0 | T-40 | ● | 62079 NIEUW | 50 | VARIANTA | 200 |
| | 500 | 460 | 10,0 | T-40 | ● | 62080 NIEUW | 50 | VARIANTA | 200 |
| | 550 | 510 | 10,0 | T-40 | ● | 62081 NIEUW | 50 | VARIANTA | 200 |
| 600 | 560 | 10,0 | T-40 | ● | 62082 NIEUW | 50 | VARIANTA | - | |

Uitvoering: cilinderkop

Aandrijving: T-Drive

Draadtype: voldraad

Materiaal: koolstofstaal

Oppervlakte: verzinkt blauw, A3K **CHROME (VI) FREE +**

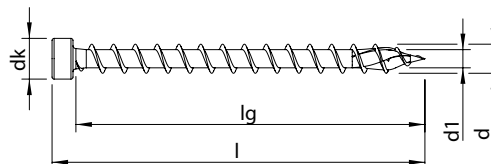

| Afmeting d x l [mm] | Draadlengte lg [mm] | Kopdiameter dk [mm] | Aandrijving | ETA | Artikelnummer | Aantal per verpakking [st.] | Type verpakking | Aantal per omverpakking [st.] | |
|---------------------|---------------------|---------------------|-------------|------|---------------|------------------------------------|-----------------|-------------------------------|-------|
| 10,0 ★ | 120 | 110 | 14,0 | T-40 | ● | 61939 | 50 | VARIANTA | 200 |
| | 160 | 150 | 14,0 | T-40 | ● | 61940 | 50 | VARIANTA | 200 |
| | 200 | 190 | 14,0 | T-40 | ● | 61941 | 50 | VARIANTA | 200 |
| | 220 | 210 | 14,0 | T-40 | ● | 61942 | 50 | VARIANTA | 200 |
| | 240 | 230 | 14,0 | T-40 | ● | 61943 | 50 | VARIANTA | 100 |
| | 260 | 250 | 14,0 | T-40 | ● | 61944 | 50 | VARIANTA | 100 |
| | 280 | 270 | 14,0 | T-40 | ● | 61945 | 50 | VARIANTA | 100 |
| | 300 | 290 | 14,0 | T-40 | ● | 61946 | 50 | VARIANTA | 100 |
| | 340 | 330 | 14,0 | T-40 | ● | 61947 | 50 | VARIANTA | 100 |
| | 380 | 370 | 14,0 | T-40 | ● | 61948 | 50 | VARIANTA | 100 |
| 10,0 ★ | 400 | 345 | 14,0 | T-50 | ● | 62071 NIEUW | 50 | VARIANTA | 200 |
| | 450 | 395 | 14,0 | T-50 | ● | 62072 NIEUW | 50 | VARIANTA | 200 |
| | 500 | 445 | 14,0 | T-50 | ● | 62073 NIEUW | 25 | VARIANTA | 100 |
| | 550 | 495 | 14,0 | T-50 | ● | 62074 NIEUW | 25 | VARIANTA | 100 |
| | 600 | 545 | 14,0 | T-50 | ● | 62075 NIEUW | 25 | VARIANTA | 1.000 |
| | 700 | 645 | 14,0 | T-50 | ● | 62076 NIEUW | 25 | VARIANTA | 1.000 |
| | 800 | 745 | 14,0 | T-50 | ● | 62077 NIEUW | 25 | VARIANTA | 1.000 |



HECO-TOPIX®-plus Vloerplaatschroef

Product informatie

- Aantrekken en fixeren met slechts één schroef
- Gereduceerde splijtwerking bij het inschroeven door boorpunt
- Snel aanzetten en inschroeven, in het bijzonder op harde oppervlakten
- Geen knarsen van het hout dankzij fixatie met de voldraad
- Tijdsbesparing door de inzet van één schroefvariant
- Goedgekeurd en bewaakt product (CE-markering)



De unieke vloerplaatschroef met het samentrekeffect

Platverzonken kop met freesholtes

Uitstekende freeseigenschappen in hout. Geen beschadiging van het oppervlak bij metalen beslag.



MagicClose®

Gepatenteerde voldraad trekt houten onderdelen spleetvrij samen zonder voorspannen

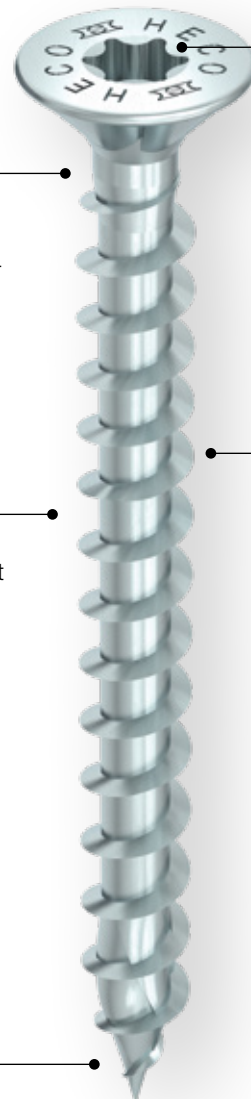

GripFit®

HECO-Drive maakt werken met één hand mogelijk



PerfectPitch®

Optimale schroefdraadspeed voor elke schroeflengte



HECO-TOPIX-plus-punt

Maakt voorboren overbodig en vermindert het risico van splijten van het hout



Uitvoering: vloerplaat Schroef, platverzonken kop met freesholtes

Aandrijving: HECO-Drive *

Draadtype: variabele voldraad

Materiaal: koolstofstaal

Oppervlakte: verzinkt blauw, A3K **CHROME (VI) FREE +**

Kleurcode op het HECO-etiket

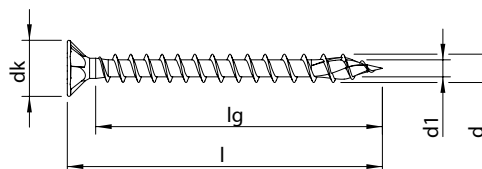
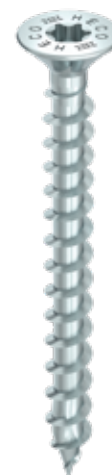

| Afmeting d x l [mm] | Draadlengte lg [mm] | Kopdiameter dk [mm] | Aandrijving | ETA | Artikelnummer | Aantal per verpakking [st.] | Type verpakking | Aantal per omverpakking [st.] | |
|---------------------|---------------------|---------------------|-------------|-------|---------------|-----------------------------|-----------------|-------------------------------|-------|
| 4,5 | 40 | 35 | 8,9 | HD-20 | • | 62107 | 500 | VARIANTA | 5.000 |
| | 50 | 45 | 8,9 | HD-20 | • | 60722 | 200 | VARIANTA | 2.000 |
| | 60 | 55 | 8,9 | HD-20 | • | 60752 | 200 | VARIANTA | 2.000 |
| | 70 | 65 | 8,9 | HD-20 | • | 60769 | 200 | VARIANTA | 2.000 |
| | 80 | 75 | 8,9 | HD-20 | • | 60781 | 200 | VARIANTA | 2.000 |

* Alle schroeven met HECO-Drive zijn 100% compatibel met conventionele TX-bits.
Het GripFit-effect is alleen gegarandeerd bij gebruik met bijpassende HECO-Drive-bits.



HECO-TOPIX®-plus Vloerschroef

Product informatie

- Aantrekken en fixeren met slechts één schroef
- Gereduceerde splijtwerking bij het inschroeven door boorpunt
- Geen knarsen van de vloerplanken door vaste fixering met de voldraad
- Makkelijk verzinken van de kop in de veer en verminderde spreidwerking
- Tijdsbesparing door de inzet van één schroefvariant
- Goedgekeurd en bewaakt product (CE-markering)



De unieke vloerschroef met het samentrekeffect

Kleine lenskop met freesribben

Voor gemakkelijk verzinken in de veer

MagicClose®

Gepatenteerde voldraad trekt houten onderdelen spleetvrij samen zonder voorspannen

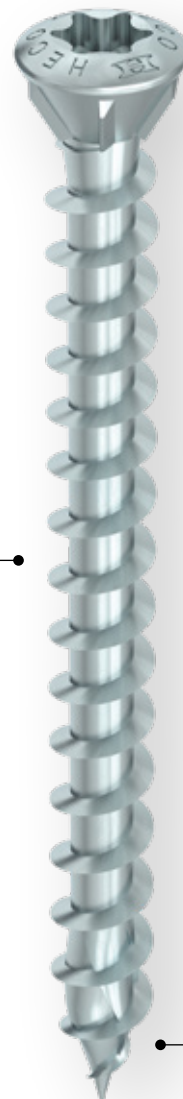

PerfectPitch®

Optimale schroefdraadspoed voor elke schroeflengte



HECO-TOPIX-plus-punt

Maakt voorboren overbodig en vermindert het risico van splijten van het hout

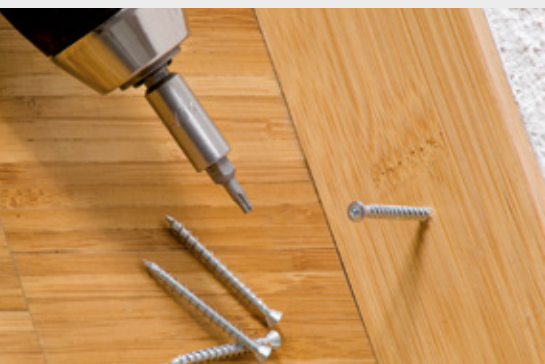

Uitvoering: vloerschroef, verzonken lenskop met freesribben

Aandrijving: T-Drive

Draadtype: variabele voldraad

Materiaal: koolstofstaal

Oppervlakte: verzinkt blauw, A3K **CHROME (VI) FREE +**

Kleurcode op het HECO-etiket

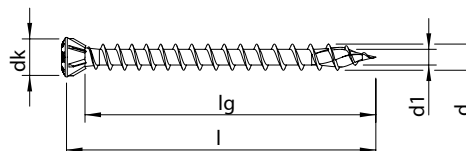

| Afmeting d x l [mm] | Draadlengte lg [mm] | Kopdiameter dk [mm] | Aandrijving | ETA | Artikelnummer | Aantal per verpakking [st.] | Type verpakking | Aantal per omverpakking [st.] | |
|---------------------|---------------------|---------------------|-------------|------|---------------|-----------------------------|-----------------|-------------------------------|-------|
| 3,5 | 40 | 37 | 5,3 | T-10 | ● | 60293 | 200 | SKV | 4.000 |
| | 40 | 37 | 5,3 | T-10 | ● | 60294 | 500 | VARIANTA | 5.000 |
| | 50 | 47 | 5,3 | T-10 | ● | 60328 | 200 | SKV | 4.000 |
| | 50 | 47 | 5,3 | T-10 | ● | 60329 | 500 | VARIANTA | 5.000 |
| | 60 | 57 | 5,3 | T-10 | ● | 60346 | 200 | VARIANTA | 2.000 |
| | 60 | 57 | 5,3 | T-10 | ● | 60348 | 500 | VARIANTA | 5.000 |
| 4,0 | 70 | 66 | 6,1 | T-15 | ● | 60564 | 200 | VARIANTA | 2.000 |
| | 70 | 66 | 6,1 | T-15 | ● | 60565 | 500 | VARIANTA | 2.000 |
| 4,5 | 50 | 46 | 6,8 | T-20 | ● | 60719 | 200 | VARIANTA | 2.000 |
| | 50 | 46 | 6,8 | T-20 | ● | 60721 | 500 | VARIANTA | 5.000 |
| | 60 | 56 | 6,8 | T-20 | ● | 60750 | 200 | VARIANTA | 2.000 |
| | 60 | 56 | 6,8 | T-20 | ● | 60751 | 500 | VARIANTA | 2.000 |
| | 70 | 66 | 6,8 | T-20 | ● | 60766 | 200 | VARIANTA | 2.000 |
| | 70 | 66 | 6,8 | T-20 | ● | 60768 | 500 | VARIANTA | 2.000 |
| | 80 | 76 | 6,8 | T-20 | ● | 60779 | 200 | VARIANTA | 2.000 |
| | 80 | 76 | 6,8 | T-20 | ● | 60780 | 500 | VARIANTA | 2.000 |

85

Uitvoering: vloerschroef, verzonken lenskop met freesribben

Aandrijving: T-Drive

Draadtype: variabele voldraad

Materiaal: roestvaststaal A2 1.4567

Oppervlakte: blank, glijcoating

Kleurcode op het HECO-etiket

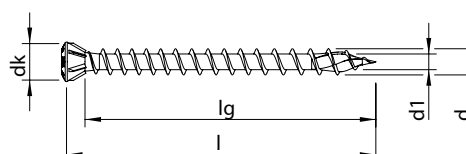

| Afmeting d x l [mm] | Draadlengte lg [mm] | Kopdiameter dk [mm] | Aandrijving | ETA | Artikelnummer | Aantal per verpakking [st.] | Type verpakking | Aantal per omverpakking [st.] | |
|---------------------|---------------------|---------------------|-------------|------|---------------|-----------------------------|-----------------|-------------------------------|-------|
| 3,5 | 40 | 37 | 5,3 | T-10 | ● | 61644 | 200 | SKV | 4.000 |
| | 50 | 47 | 5,3 | T-10 | ● | 61651 | 200 | SKV | 4.000 |
| | 60 | 57 | 5,3 | T-10 | ● | 61654 | 200 | SKV | 4.000 |



HECO-TOPIX®-plus Gevelschroef

Product informatie

- Aantrekken en fixeren van de gevelplank met één schroef
- Duurzame fixering en hogere aantreklasten dankzij HECO-TOPIX-plus voldraad
- Splijtvrij aantrekken van de gevelplank
- Uitvoering in roestvaststaal A2 voor duurzame en gestandaardiseerde montage voor gebruiksklasse 3
- Goedgekeurd en bewaakt product (CE-markering)



De unieke gevelschroef met het samentrekeffect

Kleine lenskop

Voor optische mooie montage en minder vochtophoping

GripFit®

HECO-Drive maakt werken met één hand mogelijk



MagicClose®

Gepatenteerde voldraad trekt houten onderdelen spleetvrij samen zonder voorspannen



PerfectPitch®

Optimale schroefdraadspoed voor elke schroeflengte



HECO-TOPIX-plus-punt

Maakt voorboren overbodig en vermindert het risico van splijten van het hout

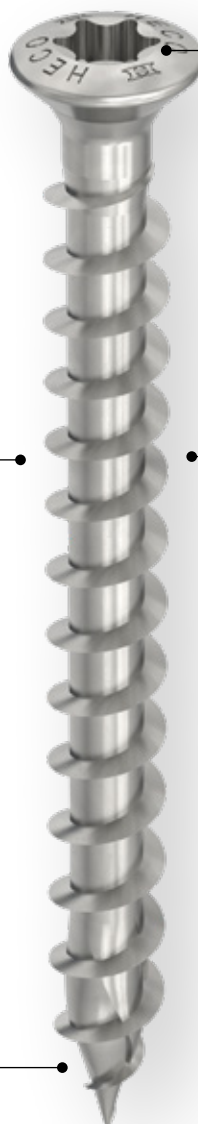

Uitvoering: gevelschroef, verzonken lenskop

Aandrijving: HECO-Drive*



Draadtype: variabele voldraad

Materiaal: roestvaststaal A2 1.4567

Oppervlakte: blank, glijcoating

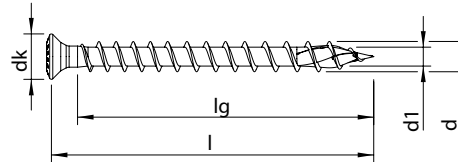
Kleurcode op het HECO-etiket



| Afmeting d x l [mm] | Draadlengte lg [mm] | Kopdiameter dk [mm] | Aandrijving | ETA | Artikelnummer | Aantal per verpakking [st.] | Type verpakking | Aantal per omverpakking [st.] | |
|--|---------------------|---------------------|-------------|-------|---------------|-----------------------------|-----------------|-------------------------------|-------|
| 4,5  | 50 | 45 | 7,2 | HD-20 | • | 61706 | 200 | VARIANTA | 2.000 |
| | 60 | 55 | 7,2 | HD-20 | • | 61711 | 200 | VARIANTA | 2.000 |
| | 70 | 65 | 7,2 | HD-20 | • | 61715 | 200 | VARIANTA | 2.000 |
| | 80 | 75 | 7,2 | HD-20 | • | 61720 | 200 | VARIANTA | 2.000 |
| 5,0  | 40 | 34 | 7,2 | HD-20 | • | 61743 | 200 | VARIANTA | 2.000 |
| | 50 | 44 | 7,2 | HD-20 | • | 61759 | 200 | VARIANTA | 2.000 |
| | 60 | 54 | 7,2 | HD-20 | • | 61772 | 200 | VARIANTA | 2.000 |
| | 70 | 64 | 7,2 | HD-20 | • | 61783 | 200 | VARIANTA | 2.000 |
| | 80 | 74 | 7,2 | HD-20 | • | 61793 | 200 | VARIANTA | 2.000 |

* Alle schroeven met HECO-Drive zijn 100% compatibel met conventionele TX-bits.
Het GripFit-effect is alleen gegarandeerd bij gebruik met bijpassende HECO-Drive-bits.



HECO-TOPIX®-plus Scharnierschroef

Product informatie

- Geen beschadigingen van het beslag
- Remmende werking van de kop verhindert doordraaien van de schroef
- Van glijmiddel voorzien voor minimaal inschroefdraaimoment
- Universele toepassing in vele houtsoorten
- Coating zonder chroom-VI
- Goedgekeurd en bewaakt product (CE-markering)



De scharnierschroef voor de professional

Speciale kop met aangepaste helling

voor een snelle montage zonder het oppervlakte beschadigen
geen doordraaien van de schroef

GripFit®

HECO-Drive maakt werken met één hand mogelijk



PerfectPitch®

Optimale schroefdraadspoed voor elke schroeflengte

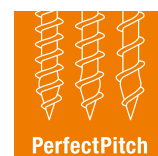

HECO-TOPIX-plus-punt

Maakt voorboren overbodig en vermindert het risico van splijten van het hout

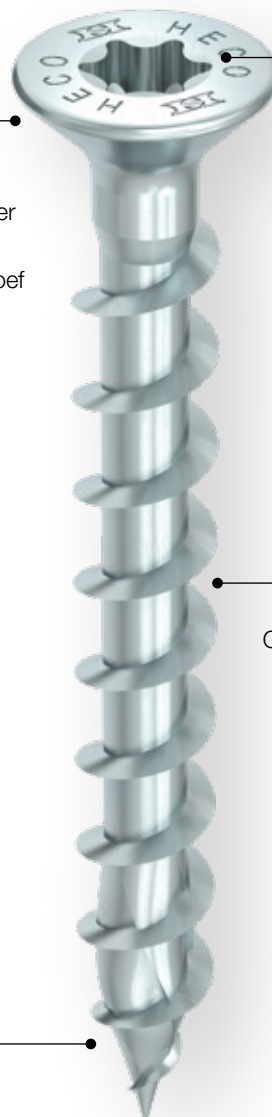

Uitvoering: scharnierschroef, platverzonken kop met freesholtes

Aandrijving: T-Drive

Draadtype: voldraad

Materiaal: koolstofstaal

Oppervlakte: verzinkt blauw, A3K **CHROME (VI) FREE +**

Kleurcode op het HECO-etiket

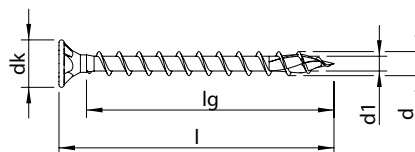

| Afmeting d x l [mm] | Draadlengte lg [mm] | Kopdiameter dk [mm] | Aandrijving | ETA | Artikelnummer | Aantal per verpakking [st.] | Type verpakking | Aantal per omverpakking [st.] |
|---------------------|---------------------|---------------------|-------------|------|--------------------|-----------------------------|-----------------|-------------------------------|
| 3,5 | 12 | 9 | 6,9 | T-15 | 62236 NIEUW | 1.000 | VARIANTA | 10.000 |
| | 16 | 13 | 6,9 | T-15 | 62237 NIEUW | 1.000 | VARIANTA | 10.000 |
| | 20 | 16 | 6,9 | T-15 | 62238 NIEUW | 1.000 | VARIANTA | 10.000 |
| | 25 | 21 | 6,9 | T-15 | 62239 NIEUW | 1.000 | VARIANTA | 10.000 |
| | 30 | 26 | 6,9 | T-15 | 62240 NIEUW | 1.000 | VARIANTA | 10.000 |
| | 35 | 31 | 6,9 | T-15 | 62244 NIEUW | 1.000 | VARIANTA | 10.000 |
| | 40 | 36 | 6,9 | T-15 | 62241 NIEUW | 500 | VARIANTA | 5.000 |
| | 50 | 46 | 6,9 | T-15 | 62242 NIEUW | 500 | VARIANTA | 5.000 |

Uitvoering: scharnierschroef, platverzonken kop met freesholtes

Aandrijving: Pozi-Drive

Draadtype: voldraad

Materiaal: koolstofstaal

Oppervlakte: verzinkt blauw, A3K **CHROME (VI) FREE +**

Kleurcode op het HECO-etiket

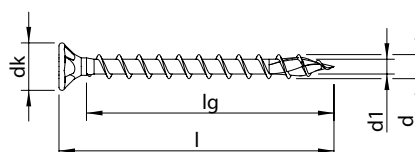

| Afmeting d x l [mm] | Draadlengte lg [mm] | Kopdiameter dk [mm] | Aandrijving | ETA | Artikelnummer | Aantal per verpakking [st.] | Type verpakking | Aantal per omverpakking [st.] |
|---------------------|---------------------|---------------------|-------------|-------|--------------------|-----------------------------|-----------------|-------------------------------|
| 3,5 | 12 | 9 | 6,9 | PZD-2 | 62229 NIEUW | 1.000 | VARIANTA | 10.000 |
| | 16 | 13 | 6,9 | PZD-2 | 62230 NIEUW | 1.000 | VARIANTA | 10.000 |
| | 20 | 16 | 6,9 | PZD-2 | 62231 NIEUW | 1.000 | VARIANTA | 10.000 |
| | 25 | 21 | 6,9 | PZD-2 | 62232 NIEUW | 1.000 | VARIANTA | 10.000 |
| | 30 | 26 | 6,9 | PZD-2 | 62233 NIEUW | 1.000 | VARIANTA | 10.000 |
| | 35 | 31 | 6,9 | PZD-2 | 62243 NIEUW | 1.000 | VARIANTA | 10.000 |
| | 40 | 36 | 6,9 | PZD-2 | 62234 NIEUW | 500 | VARIANTA | 5.000 |
| | 50 | 46 | 6,9 | PZD-2 | 62235 NIEUW | 500 | VARIANTA | 5.000 |



Uitvoering: scharnierschroef, platverzonken kop

Aandrijving: HECO-Drive*

Draadtype: variabele voldraad

Materiaal: koolstofstaal

Oppervlakte: verzinkt blauw, A3K **CHROME (VI) FREE +**

Kleurcode op het HECO-etiket

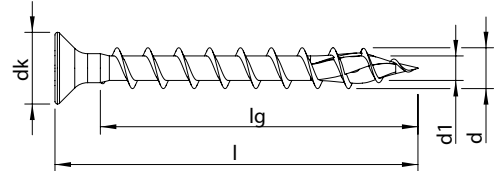

| Afmeting d x l [mm] | Draadlengte lg [mm] | Kopdiameter dk [mm] | Aandrijving | ETA | Artikelnummer | Aantal per verpakking [st.] | Type verpakking | Aantal per omverpakking [st.] | |
|---------------------|---------------------|---------------------|-------------|-------|---------------|-----------------------------|-----------------|-------------------------------|-------|
| 4,5** | 40 | 35 | 7,9 | HD-20 | ● | 60694 | 500 | VARIANTA | 5.000 |

* Alle schroeven met HECO-Drive zijn 100% compatibel met conventionele TX-bits.
Het GripFit-effect is alleen gegarandeerd bij gebruik met bijpassende HECO-Drive-bits.

** Kleurcodering HD-20-bit = ●



Uitvoering: scharnierschroef, platverzonken kop

Aandrijving: HECO-Drive*

Draadtype: variabele voldraad

Materiaal: roestvaststaal A2 1.4567

Oppervlakte: blank, glijcoating

Kleurcode op het HECO-etiket

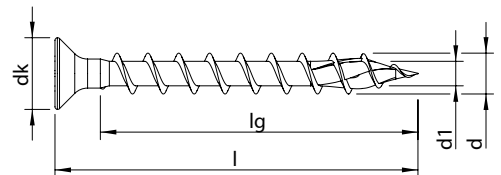

| Afmeting d x l [mm] | Draadlengte lg [mm] | Kopdiameter dk [mm] | Aandrijving | ETA | Artikelnummer | Aantal per verpakking [st.] | Type verpakking | Aantal per omverpakking [st.] | |
|---------------------|---------------------|---------------------|-------------|-------|---------------|-----------------------------|-----------------|-------------------------------|-------|
| 4,5** | 40 | 35 | 7,9 | HD-20 | ● | 61701 | 500 | VARIANTA | 5.000 |

* Alle schroeven met HECO-Drive zijn 100% compatibel met conventionele TX-bits.
Het GripFit-effect is alleen gegarandeerd bij gebruik met bijpassende HECO-Drive-bits.

** Kleurcodering HD-20-bit = ●

Uitvoering: scharnierschroef, platverzonken kop

Aandrijving: Pozi-Drive

Draadtype: variabele voldraad

Materiaal: koolstofstaal

Oppervlakte: verzinkt blauw, A3K **CHROME (VI) FREE +**

Kleurcode op het HECO-etiket

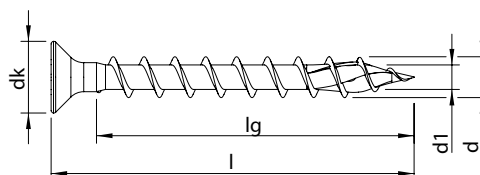

| Afmeting d x l [mm] | Draadlengte lg [mm] | Kopdiameter dk [mm] | Aandrijving | ETA | Artikelnummer | Aantal per verpakking [st.] | Type verpakking | Aantal per omverpakking [st.] |
|---------------------|---------------------|---------------------|-------------|-----|---------------|-----------------------------|-----------------|-------------------------------|
| 4,5* | 40 | 35 | PZD-2 | ● | 62050 | 500 | VARIANTA | 5.000 |

* Kleurcodering PZD-2-bit =

Uitvoering: scharnierschroef, platverzonken kop

Aandrijving: Pozi-Drive

Draadtype: variabele voldraad

Materiaal: roestvaststaal A2 1.4567

Oppervlakte: blank, glijcoating

Kleurcode op het HECO-etiket



91

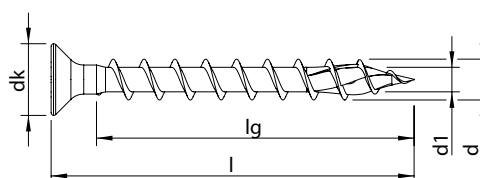

| Afmeting d x l [mm] | Draadlengte lg [mm] | Kopdiameter dk [mm] | Aandrijving | ETA | Artikelnummer | Aantal per verpakking [st.] | Type verpakking | Aantal per omverpakking [st.] |
|---------------------|---------------------|---------------------|-------------|-----|---------------|-----------------------------|-----------------|-------------------------------|
| 4,5* | 40 | 35 | PZD-2 | ● | 62051 | 500 | VARIANTA | 5.000 |

* Kleurcodering PZD-2-bit =



HECO-TOPIX®-plus Glaslatschroef

Product informatie

- Gereduceerde splijtwerking bij het inschroeven door boorpunt
- Te gebruiken in bijna alle materialen van houtbouw
- Het kleine, iets lenskopvormige ontwerp rondt uw montage optisch af
- Coating zonder chroom-VI
- Goedgekeurd en bewaakt product (CE-markering)



De glaslatschroef voor de professional

Kleine lenskop met freesribben

Voor gemakkelijk en zuiver verzinken van de kop

Schachtribben

Verminderen het inschroefdraaimoment

HECO-TOPIX-plus-punt

Maakt voorboren overbodig en vermindert het risico van splijten van het hout

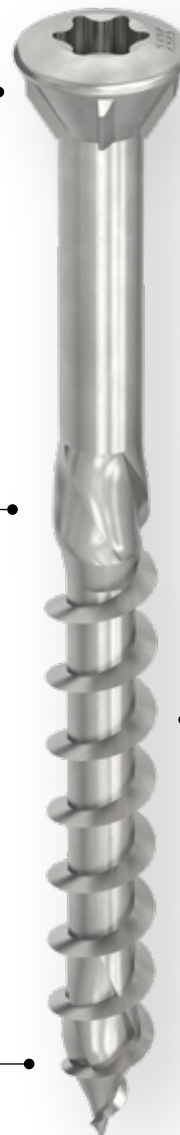

PerfectPitch®

Optimale schroefdraadspoed voor elke schroeflengte



Uitvoering: glaslatschroef, verzonken lenskop met freesribben

Aandrijving: T-Drive

Draadtype: deeldraad

Materiaal: koolstofstaal

Oppervlakte: verzinkt blauw, A3K **CHROME (VI) FREE +**

Kleurcode op het HECO-etiket

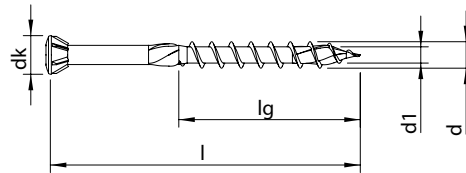

| Afmeting d x l [mm] | Draadlengte lg [mm] | Kopdiameter dk [mm] | Aandrijving | ETA | Artikelnummer | Aantal per verpakking [st.] | Type verpakking | Aantal per omverpakking [st.] | |
|---------------------|---------------------|---------------------|-------------|------|---------------|-----------------------------|-----------------|-------------------------------|--------|
| 3,5 | 30 | 18 | 5,3 | T-10 | ● | 60249 | 1.000 | VARIANTA | 10.000 |
| | 35 | 21 | 5,3 | T-10 | ● | 60272 | 1.000 | VARIANTA | 10.000 |
| | 40 | 27 | 5,3 | T-10 | ● | 60296 | 500 | VARIANTA | 5.000 |
| | 50 | 27 | 5,3 | T-10 | ● | 60331 | 500 | VARIANTA | 5.000 |
| | 60 | 27 | 5,3 | T-10 | ● | 60349 | 200 | VARIANTA | 2.000 |

Uitvoering: glaslatschroef, verzonken lenskop met freesribben

Aandrijving: T-Drive

Draadtype: deeldraad

Materiaal: koolstofstaal

Oppervlakte: verzinkt geel, A3L **CHROME (VI) FREE +**

Kleurcode op het HECO-etiket

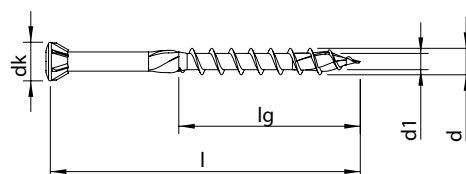

| Abmessung d x l [mm] | Gewindelänge lg [mm] | Kopf-Ø dk [mm] | Antriebsgröße | ETA | Artikelnummer | VE [Stk.] | Verpackungstyp | Umkarton [Stk.] |
|----------------------|----------------------|----------------|---------------|------|---------------|-----------------------|----------------|-----------------|
| 3,5 | 30 | 18 | 5,3 | T-10 | ● | 60250 | VARIANTA | 10.000 |
| | 35 | 21 | 5,3 | T-10 | ● | 60273 | VARIANTA | 10.000 |
| | 40 | 27 | 5,3 | T-10 | ● | 60297 | VARIANTA | 5.000 |



Uitvoering: glaslatschroef, verzonken lenskop met freesribben

Aandrijving: T-Drive

Draadtype: deeldraad

Materiaal: roestvaststaal A2 1.4567

Oppervlakte: blank, glijcoating

Kleurcode op het
HECO-etiket

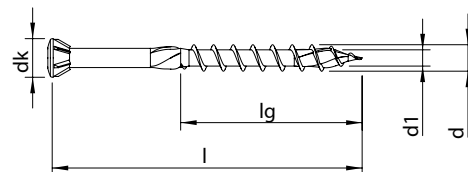

| Afmeting d x l [mm] | Draadlengte lg [mm] | Kopdiameter dk [mm] | Aandrijving | ETA | Artikelnummer | Aantal per verpakking [st.] | Type verpakking | Aantal per om- verpakking [st.] | |
|---|------------------------|------------------------|-------------|------|---------------|--------------------------------|--------------------|------------------------------------|-------|
| 3,5 | 40 | 27 | 5,3 | T-10 | • | 61645 | 200 | SKV | 4.000 |
|  | 50 | 27 | 5,3 | T-10 | • | 61652 | 200 | SKV | 4.000 |
| | 60 | 27 | 5,3 | T-10 | • | 61655 | 200 | SKV | 4.000 |



© monropic - Fotolia.com

HECO-TOPIX®-plus Vlonderschroeven

Product informatie

- Gereduceerde splijtwerking bij het inschroeven door boorpunt
- Speciale coating voor een gering inschroefdraaimoment
- Gebruik ook in hardhout mogelijk (voorboren aanbevolen)
- Klemt niet bij schroefschacht
- Roestvrij staal A2 en A4 voor montagewerkzaamheden buiten
- Goedgekeurd en bewaakt product (CE-markering)



De standaard vlonderschroef met deeldraad

Kleine platverzonken kop met freesribben

Voor eenvoudig en zuiver kopverzinken

Schachtribben

Maken gemakkelijk inschroeven zonder mechanische spanning mogelijk

HECO-TOPIX-plus-punt

Maakt voorboren overbodig en vermindert het risico van splijten van het hout



GripFit®

HECO-Drive maakt werken met één hand mogelijk



GripFit

PerfectPitch®

Optimale schroefdraadspoed voor elke schroeflengte



PerfectPitch



© monropic - Fotolia.com

Uitvoering: vlonderschroef, platverzonken kop met freesribben

Aandrijving: HECO-Drive*

Draadtype: deeldraad

Materiaal: roestvaststaal A2 1.4567

Oppervlakte: blank, glijcoating

Kleurcode op het HECO-etiket

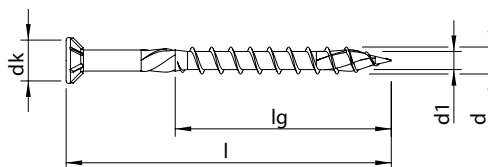

| Afmeting d x l [mm] | Draadlengte lg [mm] | Kopdiameter dk [mm] | Aandrijving | ETA | Artikelnummer | Aantal per verpakking [st.] | Type verpakking | Aantal per omverpakking [st.] |
|---------------------|---------------------|---------------------|-------------|-------|---------------|-----------------------------|------------------|-------------------------------|
| 5,0 | 40 | 24 | 8,5 | HD-20 | 61739 | 200 | VARIANTA | 2.000 |
| | 45 | 27 | 8,5 | HD-20 | 61749 | 200 | VARIANTA | 2.000 |
| | 50 | 30 | 8,5 | HD-20 | 61753 | 200 | VARIANTA | 2.000 |
| | 50 | 30 | 8,5 | HD-20 | 61755 | 500 | Kunststof doos** | 2.000 |
| | 60 | 36 | 8,5 | HD-20 | 61766 | 200 | VARIANTA | 2.000 |
| | 60 | 36 | 8,5 | HD-20 | 61768 | 350 | Kunststof doos** | 1.400 |
| | 70 | 42 | 8,5 | HD-20 | 61777 | 200 | VARIANTA | 2.000 |
| | 70 | 42 | 8,5 | HD-20 | 61779 | 350 | Kunststof doos** | 1.400 |
| | 80 | 42 | 8,5 | HD-20 | 61787 | 200 | VARIANTA | 2.000 |
| | 80 | 42 | 8,5 | HD-20 | 61789 | 350 | Kunststof doos** | 1.400 |

97

Uitvoering: vlonderschroef, platverzonken kop met freesribben

Aandrijving: HECO-Drive*

Draadtype: deeldraad

Materiaal: roestvaststaal A4 1.4578

Oppervlakte: blank, glijcoating

Kleurcode op het HECO-etiket

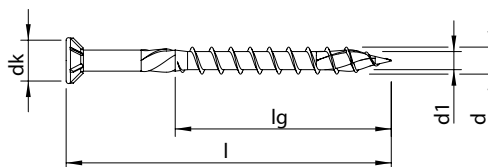

| Afmeting d x l [mm] | Draadlengte lg [mm] | Kopdiameter dk [mm] | Aandrijving | ETA | Artikelnummer | Aantal per verpakking [st.] | Type verpakking | Aantal per omverpakking [st.] |
|---------------------|---------------------|---------------------|-------------|-------|---------------|-----------------------------|-----------------|-------------------------------|
| 5,0 | 50 | 30 | 8,5 | HD-20 | 61916 | 200 | VARIANTA | 2.000 |
| | 60 | 36 | 8,5 | HD-20 | 61919 | 200 | VARIANTA | 2.000 |
| | 70 | 42 | 8,5 | HD-20 | 61922 | 200 | VARIANTA | 2.000 |
| | 80 | 42 | 8,5 | HD-20 | 61925 | 200 | VARIANTA | 2.000 |

* Alle schroeven met HECO-Drive zijn 100% compatibel met conventionele TX-bits. Het GripFit-effect is alleen gegarandeerd bij gebruik met bijpassende HECO-Drive-bits.

** Kunststof doos: minimale bestelhoeveelheid 1 omverpakking. De bijbehorende boren t.b.v. vlonderplank vindt u op pagina 175



HECO-TOPIX®-plus Vlonderschroeven

Product informatie

- Onderkopdraad voor de fixatie van de vlonderdelen ter voorkoming van knarsende geluiden
- Gereduceerde splijtwerking bij het inschroeven door boorpunt
- Gebruik ook in hardhout mogelijk (voorboren aanbevolen)
- Speciale coating voor een gering inschroefdraaimoment en gemakkelijk uitschroeven
- Roestvrij staal A2 en A4 voor montagewerkzaamheden buiten



De professionele vlonderschroef met onderkopdraad

Kleine verzonken lenskop

Voor eenvoudig kopverzinken met een optimaal design

Onderkopdraad

Voor de fixatie van de vlonderdelen

HECO-TOPIX-plus-punt

Maakt voorboren overbodig en vermindert het risico van splijten van het hout



GripFit®

HECO-Drive maakt werken met één hand mogelijk



GripFit

PerfectPitch®

Optimale schroefdraadspoed voor elke schroeflengte



PerfectPitch



Uitvoering: vlonderschroef, verzonken lenskop

Aandrijving: HECO-Drive*

Draadtype: onderkopdraad

Materiaal: roestvaststaal A2 1.4567

Oppervlakte: blank, glijcoating



Kleurcode op het HECO-etiket

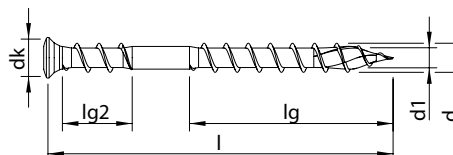

| Afmeting d x l [mm] | Draadlengte lg [mm] | Kopdiameter dk [mm] | Aandrijving | ETA | Artikelnummer | Aantal per verpakking [st.] | Type verpakking | Aantal per omverpakking [st.] |
|---------------------|---------------------|---------------------|-------------|-------|---------------|-----------------------------|------------------|-------------------------------|
| 5,0 | 40 | 16/9 | 7,0 | HD-20 | 61741 | 200 | VARIANTA | 2.000 |
| | 50 | 25/10 | 7,0 | HD-20 | 61756 | 200 | VARIANTA | 2.000 |
| | 50 | 25/10 | 7,0 | HD-20 | 61758 | 500 | Kunststof doos** | 2.000 |
| | 60 | 35/12 | 7,0 | HD-20 | 61769 | 200 | VARIANTA | 2.000 |
| | 60 | 35/12 | 7,0 | HD-20 | 61771 | 350 | Kunststof doos** | 1.400 |
| | 70 | 40/12 | 7,0 | HD-20 | 61780 | 200 | VARIANTA | 2.000 |
| | 70 | 40/12 | 7,0 | HD-20 | 61782 | 350 | Kunststof doos** | 1.400 |
| | 80 | 40/12 | 7,0 | HD-20 | 61790 | 200 | VARIANTA | 2.000 |

Uitvoering: vlonderschroef, verzonken lenskop

Aandrijving: HECO-Drive*

Draadtype: onderkopdraad

Materiaal: roestvaststaal A4 1.4578

Oppervlakte: blank, glijcoating



Kleurcode op het HECO-etiket

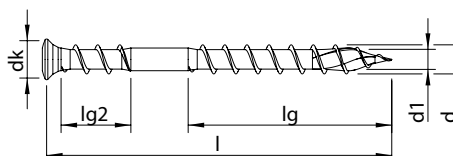

| Afmeting d x l [mm] | Draadlengte lg [mm] | Kopdiameter dk [mm] | Aandrijving | ETA | Artikelnummer | Aantal per verpakking [st.] | Type verpakking | Aantal per omverpakking [st.] |
|---------------------|---------------------|---------------------|-------------|-------|---------------|-----------------------------|-----------------|-------------------------------|
| 5,0 | 50 | 25/10 | 7,0 | HD-20 | 61917 | 200 | VARIANTA | 2.000 |
| | 60 | 35/12 | 7,0 | HD-20 | 61920 | 200 | VARIANTA | 2.000 |
| | 70 | 40/12 | 7,0 | HD-20 | 61923 | 200 | VARIANTA | 2.000 |

* Alle schroeven met HECO-Drive zijn 100% compatibel met conventionele TX-bits. Het GripFit-effect is alleen gegarandeerd bij gebruik met bijpassende HECO-Drive-bits.

** Kunststof doos: minimale bestelhoeveelheid 1 omverpakking. De bijbehorende boren t.b.v. vlonderplank vindt u op pagina 175



© Thomas Aumann - Fotolia.com

HECO-TOPIX®-plus Paalschroef

Product informatie

- Voor het bevestigen van houten palen in paalsteunen, kolomvoeten, grondankers, enz.
- Bevestiging van montage hulpstukken zoals schoren of stalen steunen
- Verbeterde corrosiebescherming door HP-coating
- Tellerkop met onder de kop een verdikte schacht; goede centreringen vlakke aansluiting van de kop op het beslag
- Snelle verwerking zonder voorboren
- Dimensioneringsbewijzen via HECO-HCS of dimensionerings-service
- Goedgekeurd en bewaakt product (CE-markering)



De ideale schroef voor gebruik in houtverbinders buiten

Tellerkop

Hogere lastoverdracht door vergroot klemvlak van de kop

MagicClose®

Gepatenteerde voldraad trekt houten onderdelen spleetvrij samen zonder voorspannen (alleen bij Ø6 mm)



HECO-TOPIX-plus-punt

Maakt voorboren overbodig en vermindert het risico van splijten van het hout

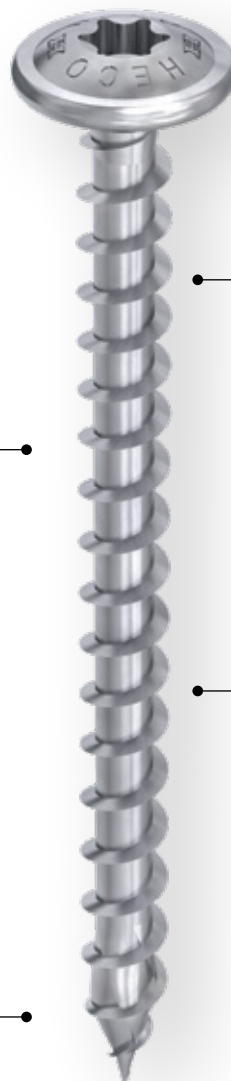

PerfectPitch®

Optimale schroefdraadspoed voor elke schroeflengte



PerfectPitch

HP-coating

Voor verbeterde corrosiebescherming



© Kaasten - Fotolia.com

Uitvoering: paalschroef, tellerkop

Aandrijving: T-Drive

Draadtype: variabele voldraad

Materiaal: koolstofstaal

Oppervlakte: HP-coating **CHROME (VI) FREE +**

Kleurcode op het HECO-etiket

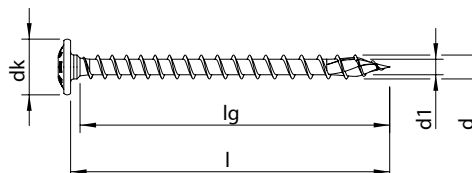

| Afmeting d x l [mm] | Draadlengte lg [mm] | Kopdiameter dk [mm] | Aandrijving | ETA | Artikelnummer | Aantal per verpakking [st.] | Type verpakking | Aantal per omverpakking [st.] | |
|---------------------|---------------------|---------------------|-------------|------|---------------|-----------------------------|-----------------|-------------------------------|-------|
| 6,0 | 40 | 36 | 14,0 | T-30 | • | 61016 | 200 | VARIANTA | 2.000 |
| | 50 | 46 | 14,0 | T-30 | • | 61041 | 200 | VARIANTA | 2.000 |
| | 60 | 56 | 14,0 | T-30 | • | 61067 | 100 | VARIANTA | 1.000 |

HECO-TOPIX-plus tellerkopschroeven in roestvrijstaal A2 vindt u op pagina 72 en 75

Uitvoering: paalschroef, tellerkop

Aandrijving: T-Drive

Draadtype: voldraad

Materiaal: koolstofstaal

Oppervlakte: HP-coating **CHROME (VI) FREE +**

Kleurcode op het HECO-etiket



101

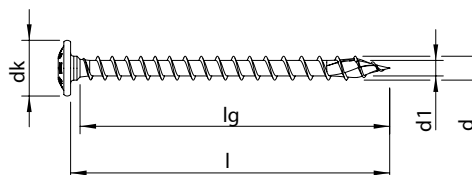

| Afmeting d x l [mm] | Draadlengte lg [mm] | Kopdiameter dk [mm] | Aandrijving | ETA | Artikelnummer | Aantal per verpakking [st.] | Type verpakking | Aantal per omverpakking [st.] | |
|---------------------|---------------------|---------------------|-------------|------|---------------|-----------------------------|-----------------|-------------------------------|-----|
| 8,0 | 40 | 34 | 18,0 | T-40 | • | 61228 | 100 | VARIANTA | 400 |
| | 50 | 44 | 18,0 | T-40 | • | 61230 | 100 | VARIANTA | 400 |
| | 60 | 54 | 18,0 | T-40 | • | 61234 | 100 | VARIANTA | 400 |

HECO-TOPIX-plus tellerkopschroeven in roestvrijstaal A2 vindt u op pagina 72 en 75

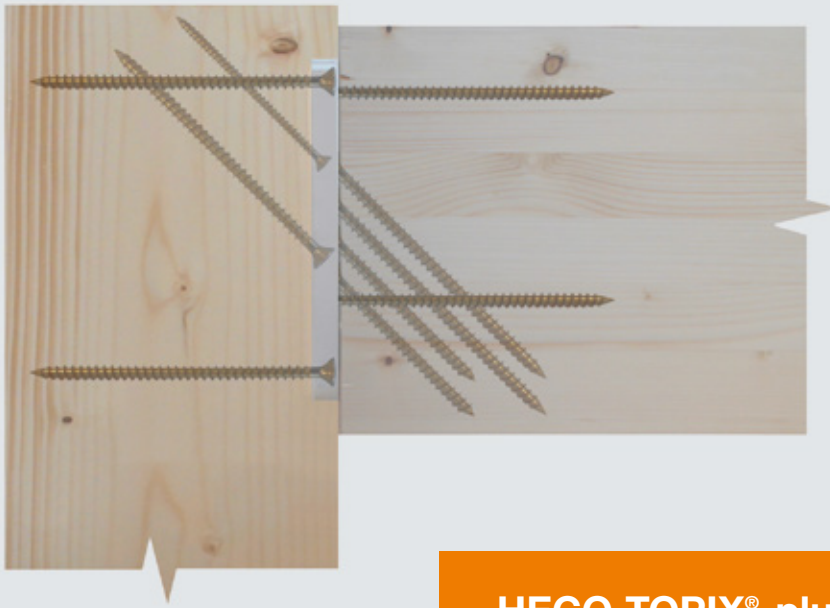

HECO-TOPIX®-plus Verbindingschroeven

Product informatie

Algemeen

- Afgestemde schroefdraadlengten voor optimaal gebruik van houtverbinders
- Verminderde rand- en asafstanden
- Onderdeel van de dimensionerings software van Pitzl
- Ook inzetbaar voor andere voldraadtoepassingen
- Goedgekeurd en bewaakt product (CE-markering)

Tellerkop

- Hogere lastoverdracht door vergroot klemvlak van de kop
- Vlak aandrukken van de verbinder
- Verdikte schacht voor een betere centrering van de houtverbinder

Platverzonken kop

- Geen beschadiging van het oppervlak bij metalen beslag



De ideale schroef voor gebruik in houtverbinders

Tellerkop



Platverzonken kop met freesholtes



GripFit®

HECO-Drive maakt werken met één hand mogelijk



GripFit

PerfectPitch®

Optimale schroefdraadspoed voor elke schroeflengte



PerfectPitch

HECO-TOPIX-plus-punt

Maakt voorboren overbodig en vermindert het risico van splijten van het hout



Uitvoering: verbindingsschroef, tellerkop

Aandrijving: T-Drive

Draadtype: voldraad

Materiaal: koolstofstaal

Oppervlakte: verzinkt blauw, A3K **CHROME (VI) FREE +**

Kleurcode op het HECO-etiket

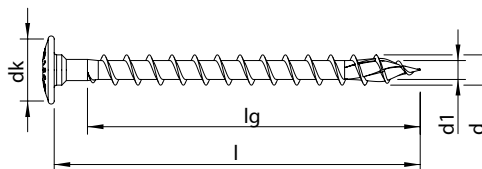
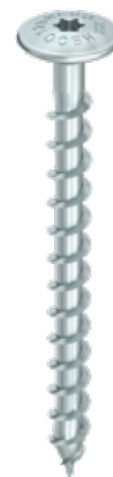

| Afmeting d x l [mm] | Draadlengte lg [mm] | Kopdiameter dk [mm] | Aandrijving | ETA | Artikelnummer | Aantal per verpakking [st.] | Type verpakking | Aantal per omverpakking [st.] | |
|---------------------|---------------------|---------------------|-------------|------|---------------|-----------------------------|-----------------|-------------------------------|-----|
| 10,0 | 120 | 110 | 22,5 | T-40 | ● | 61495 | 50 | VARIANTA | 200 |
| | 160 | 150 | 22,5 | T-40 | ● | 61510 | 50 | VARIANTA | 200 |

Uitvoering: verbindingsschroef, platverzonken kop met freesholtes

Aandrijving: HECO-Drive *

Draadtype: voldraad

Materiaal: koolstofstaal

Oppervlakte: verzinkt blauw, A3K **CHROME (VI) FREE +**

Kleurcode op het HECO-etiket

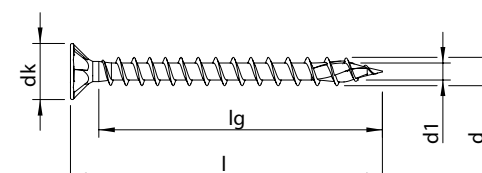

| Afmeting d x l [mm] | Draadlengte lg [mm] | Kopdiameter dk [mm] | Aandrijving | ETA | Artikelnummer | Aantal per verpakking [st.] | Type verpakking | Aantal per omverpakking [st.] | |
|---------------------|---------------------|---------------------|-------------|-------|---------------|-----------------------------|-----------------|-------------------------------|-----|
| 8,0 | 60 | 50 | 14,8 | HD-40 | ● | 61956 | 100 | VARIANTA | 400 |
| | 80 | 70 | 14,8 | HD-40 | ● | 61957 | 100 | VARIANTA | 400 |
| | 100 | 90 | 14,8 | HD-40 | ● | 61958 | 100 | VARIANTA | 400 |
| | 120 | 110 | 14,8 | HD-40 | ● | 61266 | 100 | VARIANTA | 400 |
| | 160 | 150 | 14,8 | HD-40 | ● | 61289 | 100 | VARIANTA | 400 |
| | 180 | 170 | 14,8 | HD-40 | ● | 61301 | 100 | VARIANTA | 400 |
| 10,0 | 120 | 110 | 18,5 | HD-40 | ● | 61488 | 50 | VARIANTA | 200 |
| | 160 | 150 | 18,5 | HD-40 | ● | 61506 | 50 | VARIANTA | 200 |

* Alle schroeven met HECO-Drive zijn 100% compatibel met conventionele TX-bits.
Het GripFit-effect is alleen gegarandeerd bij gebruik met passende HECO-Drive-bits.



HECO-TOPIX®-plus TCS

Product informatie

- Aandrijving: HD-30 (analoog aan HT-plus Ø 6,0). Daarom is er geen bitwisseling nodig.
- Hoge krachtoverbrenging, ook onder de moeilijkste omstandigheden
- HECO-Drive en aandrijving met GripFit-effect perfect op elkaar afgestemd
- Oppervlakte zonder chroom-VI
- Goedgekeurd en bewaakt product (CE-markering)



Voor minder bitwisselingen in houtbouw

Platverzonken kop 60° met freesribben

Voor houtverbindingen

MagicClose®

Gepatenteerde voldraad trekt houten onderdelen spleetvrij samen zonder voorspannen (alleen bij voldraad)

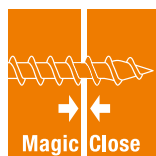

HECO-TOPIX-plus-punt

Maakt voorboren overbodig en vermindert het risico van splijten van het hout

GripFit®

HECO-Drive maakt werken met één hand mogelijk



Schachtfreesribben

Maken gemakkelijk inschroeven zonder mechanische spanning-mogelijk (alleen bij deeldraad)

PerfectPitch®

Optimale schroefdraadspoed voor elke schroeflengte

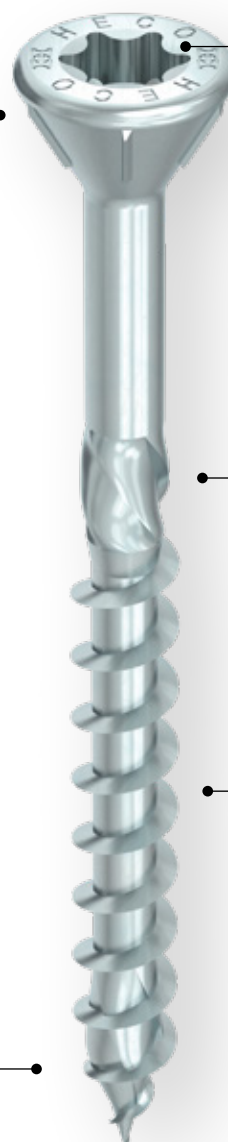

Uitvoering: platverzonken kop 60° met freesribben

Aandrijving: HECO-Drive*

Draadtype: variabele voldraad

Materiaal: koolstofstaal

Oppervlakte: verzinkt blauw, A3K **CHROME (VI) FREE +**

Kleurcode op het HECO-etiket

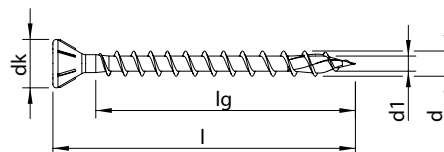

| Afmeting d x l [mm] | Draadlengte lg [mm] | Kopdiameter dk [mm] | Aandrijving | ETA | Artikelnummer | Aantal per verpakking [st.] | Type verpakking | Aantal per omverpakking [st.] | |
|---------------------|---------------------|---------------------|-------------|-------|---------------|-----------------------------|-----------------|-------------------------------|-------|
| 5,0 ★ | 40 | 32 | 9,6 | HD-30 | ● | 62097 NIEUW | 500 | VARIANTA | 5.000 |
| | 50 | 42 | 9,6 | HD-30 | ● | 62098 NIEUW | 200 | VARIANTA | 2.000 |
| | 60 | 52 | 9,6 | HD-30 | ● | 62099 NIEUW | 200 | VARIANTA | 2.000 |
| | 80 | 72 | 9,6 | HD-30 | ● | 62100 NIEUW | 200 | VARIANTA | 2.000 |
| | 100 | 92 | 9,6 | HD-30 | ● | 62101 NIEUW | 100 | VARIANTA | 1.000 |
| | 120 | 112 | 9,6 | HD-30 | ● | 62102 NIEUW | 100 | VARIANTA | 1.000 |

* Alle schroeven met HECO-Drive zijn 100% compatibel met conventionele TX-bits.
Het GripFit-effect is alleen gegarandeerd bij gebruik met bijpassende HECO-Drive-bits.

Uitvoering: platverzonken kop 60° met freesribben

Aandrijving: HECO-Drive*

Draadtype: deeldraad

Materiaal: koolstofstaal

Oppervlakte: verzinkt blauw, A3K **CHROME (VI) FREE +**

Kleurcode op het HECO-etiket

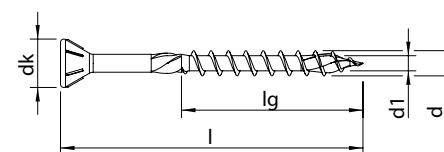

| Afmeting d x l [mm] | Draadlengte lg [mm] | Kopdiameter dk [mm] | Aandrijving | ETA | Artikelnummer | Aantal per verpakking [st.] | Type verpakking | Aantal per omverpakking [st.] | |
|---------------------|---------------------|---------------------|-------------|-------|---------------|-----------------------------|-----------------|-------------------------------|-------|
| 5,0 ★ | 40 | 24 | 9,6 | HD-30 | ● | 62091 NIEUW | 500 | VARIANTA | 5.000 |
| | 50 | 30 | 9,6 | HD-30 | ● | 62092 NIEUW | 200 | VARIANTA | 2.000 |
| | 60 | 36 | 9,6 | HD-30 | ● | 62093 NIEUW | 200 | VARIANTA | 2.000 |
| | 80 | 48 | 9,6 | HD-30 | ● | 62094 NIEUW | 200 | VARIANTA | 2.000 |
| | 100 | 60 | 9,6 | HD-30 | ● | 62095 NIEUW | 100 | VARIANTA | 1.000 |
| | 120 | 60 | 9,6 | HD-30 | ● | 62096 NIEUW | 100 | VARIANTA | 1.000 |

* Alle schroeven met HECO-Drive zijn 100% compatibel met conventionele TX-bits.
Het GripFit-effect is alleen gegarandeerd bij gebruik met bijpassende HECO-Drive-bits.



HECO-TOPIX®-plus Therm

Product informatie

- Drukkrachten worden door de onderkopdraad direct naar de spanten geleid
- Hogere lastopnames door de onderkopdraad
- Te gebruiken voor gangbare isolatiematerialen
- Dimensioneringsbewijzen via HECO-dimensioneringssoftware HCS of dimensioneringsservice
- Goedgekeurd en bewaakt product (CE-markering)



De houtschroef voor dakspanten met drukzachte isolatiematerialen

Platverzonken kop met freesholtes

Voor een eenvoudig verzinken in hout

Onderkopdraad

Leidt drukkrachten direct naar de spanten

HECO-TOPIX-plus-punt

Maakt voorboren overbodig en vermindert het risico van splijten van het hout

GripFit®

HECO-Drive maakt werken met één hand mogelijk



GripFit

PerfectPitch®

Optimale schroefdraadspoed voor elke schroeflengte



PerfectPitch



Uitvoering: HECO-TOPIX-plus Therm, platverzonken kop met freesholtes

Aandrijving: HECO-Drive *

Draadtype: onderkopdraad

Materiaal: koolstofstaal

Oppervlakte: verzinkt blauw, A3K **CHROME (VI) FREE +**

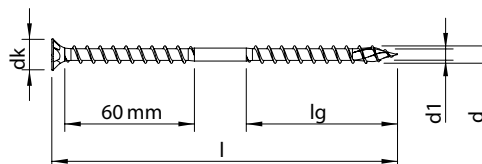

| Afmeting d x l [mm] | Draadlengte lg [mm] | Kopdiameter dk [mm] | Aandrijving | ETA | Artikelnummer | Aantal per verpakking [st.] | Type verpakking | Aantal per omverpakking [st.] | |
|---------------------|---------------------|---------------------|-------------|-------|-----------------------|-----------------------------|-----------------|-------------------------------|-----|
| 8,0 | 160 | 70 | 14,8 | HD-40 | • | 61286 | 50 | VARIANTA | 200 |
| | 200 | 100 | 14,8 | HD-40 | • | 61310 | 50 | VARIANTA | 200 |
| | 240 | 100 | 14,8 | HD-40 | • | 61333 | 50 | VARIANTA | 200 |
| | 280 | 100 | 14,8 | HD-40 | • | 61357 | 50 | VARIANTA | 200 |
| | 300 | 100 | 14,8 | HD-40 | • | 61370 | 50 | VARIANTA | 200 |
| | 330 | 100 | 14,8 | HD-40 | • | 61394 | 50 | VARIANTA | 100 |
| | 360 | 100 | 14,8 | HD-40 | • | 61406 | 50 | VARIANTA | 100 |
| | 400 | 100 | 14,8 | HD-40 | • | 61427 | 50 | VARIANTA | 100 |
| | 450 | 100 | 14,8 | HD-40 | • | 61439 | 50 | VARIANTA | 100 |
| | 500 | 100 | 14,8 | HD-40 | • | 61444 | 50 | VARIANTA | 100 |
| | 550 | 100 | 14,8 | HD-40 | • | 61954 | 50 | VARIANTA | 100 |
| 600 | 100 | 14,8 | HD-40 | • | 61955 | 50 | VARIANTA | - | |
| 10,0 | 380 | 100 | 18,5 | HD-40 | • | 61595 | 50 | VARIANTA | 100 |
| | 420 | 100 | 18,5 | HD-40 | • | 61606 | 25 | VARIANTA | 100 |
| | 460 | 100 | 18,5 | HD-40 | • | 61610 | 25 | VARIANTA | 100 |

* Alle schroeven met HECO-Drive zijn 100% compatibel met conventionele TX-bits.
 Het GripFit-effect is alleen gegarandeerd bij gebruik met bijpassende HECO-Drive-bits.

Inschroefhulp voor inschroef hoek 60° en 45° op pagina 177



HECO-TOPIX®-plus CombiConnect

Product informatie

- Overdracht van hoge trek- en drukkrachten via de CC-schroefdraad
- Trekt tijdens het schroeven de te verbinden onderdelen samen
- Universele toepassingsmogelijkheden voor nieuwbouw en renovatiewerkzaamheden
- Eenvoudig verzinken in hout
- Dimensioneringsbewijzen via HECO-dimensioneringssoftware HCS of dimensioneringsservice
- Goedgekeurd en bewaakt product (CE-markering)



De power-schroef met opnamemogelijkheid van hoge trekbelastingen

Cilinderkop

Voor splijtvrij inschroeven van de schroefkop, ook bij kleine schroefafstanden onzichtbare montage is mogelijk



Klemeffect

Door verschillende soorten schroefdraadspoed

PerfectPitch®

Optimale schroefdraadspoed voor elke schroeflengte



HECO-TOPIX-plus-punt

Maakt voorboren overbodig en vermindert het risico van splijten van het hout

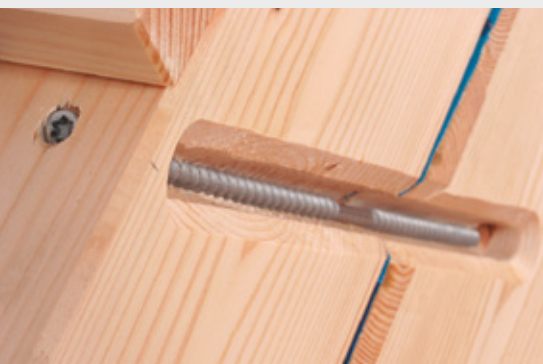



Toepassingsvoorbeelden



Opdikking

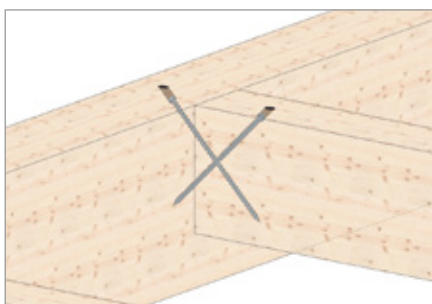

Stompe dwarsverbinding

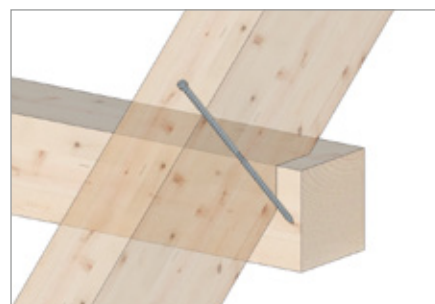

Spant-gordingverbinding



Versteviging van doorsnedeverswakkingen

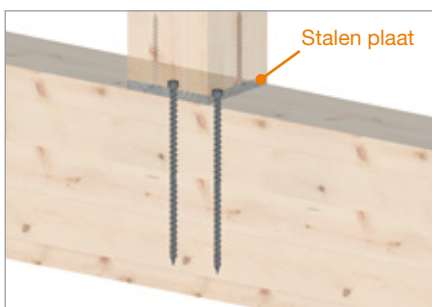

Afleiding van sterke drukkrachte



Gaten



Uitvoering: HECO-TOPIX-plus CombiConnect, cilinderkop

Aandrijving: T-Drive



Draadtype: CC-draad

Materiaal: koolstofstaal

Oppervlakte: verzinkt blauw, A3K **CHROME (VI) FREE +**

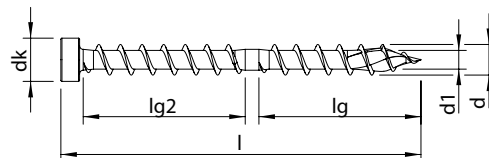
Kleurcode op het HECO-etiket



| Afmeting d x l [mm] | Draadlengte lg [mm] | Kopdiameter dk [mm] | Aandrijving | ETA | Artikelnummer | Aantal per verpakking [st.] | Type verpakking | Aantal per omverpakking [st.] | |
|---------------------|---|---------------------|-------------|------|---------------|-----------------------------|-----------------|-------------------------------|-------|
| 6,5 | 100 | 45/45 | 9,0 | T-30 | • | 61222 | 100 | VARIANTA | 1.000 |
| |  130 | 60/60 | 9,0 | T-30 | • | 61224 | 100 | VARIANTA | 1.000 |
| | 150 | 70/70 | 9,0 | T-30 | • | 61225 | 100 | VARIANTA | 400 |
| | 190 | 90/90 | 9,0 | T-30 | • | 61226 | 100 | VARIANTA | 400 |
| | 215 | 100/100 | 9,0 | T-30 | • | 61227 | 100 | VARIANTA | 400 |
| 8,5 | 100 | 45/45 | 12,0 | T-40 | • | 61448 | 100 | VARIANTA | 400 |
| |  150 | 70/70 | 12,0 | T-40 | • | 61449 | 100 | VARIANTA | 400 |
| | 190 | 90/90 | 12,0 | T-40 | • | 61452 | 100 | VARIANTA | 200 |
| | 215 | 100/100 | 12,0 | T-40 | • | 61455 | 50 | VARIANTA | 200 |
| | 250 | 110/110 | 12,0 | T-40 | • | 61457 | 50 | VARIANTA | 200 |
| | 270 | 122/122 | 12,0 | T-40 | • | 61459 | 50 | VARIANTA | 200 |
| | 300 | 138/138 | 12,0 | T-40 | • | 61461 | 50 | VARIANTA | 200 |
| | 350 | 158/158 | 12,0 | T-40 | • | 61463 | 50 | VARIANTA | 100 |
| | 400 | 182/182 | 12,0 | T-40 | • | 61466 | 50 | VARIANTA | 100 |

Inschreefhulp voor inschroef hoek 60° en 45° op pagina 177



HECO-HCS 4.0 Dimensioneringssoftware

Berekeningen met HECO-TOPIX-plus CombiConnect en vele anderen HECO-schroeven!



Product informatie

Berekeningsinstrumenten

- hoofd/hulpligger aansluitingen
- opdikkingen
- afschuif versterkingen bij doorbreken en
- inkepingen
- balkhoofdvernieuwingen
- steunpuntversterkingen
- laterale draagversterkingen
- wandaansluitingen, etc.

Meer informatie?

De uitvoerige beschrijving voor de berekeningssoftware HCS vindt u op pagina 180 van deze catalogus.

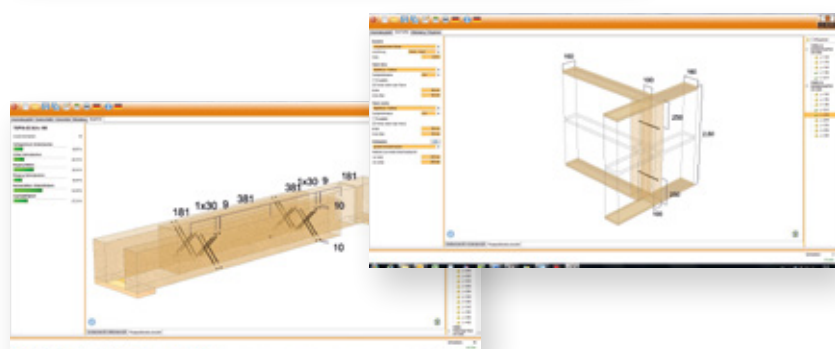



© Knauf-Thomas - MEV-Verlag - Germany

HECO-TOPIX®-plus T Solar

Product informatie

- Inzetbaar voor de montage van haken voor zonnepanelen bij daken met isolatiemateriaal op dakspanten
- Fixatie van tengel via een schroef met onderkopdraad
- Tellerkop voor een optimale fixatie van het beslag op hout
- Roestvaststaal A2 1.4567
- Goedgekeurd en bewaakt product (CE-markering)



De houtschroef voor montage van zonnepanelen bij daken met isolatiemateriaal op dakspanten

Tellerkop

Voor een optimale fixatie van het beslag op hout

Onderkopdraad

Voor het fixatie van de tengellat

HECO-TOPIX-plus-punt

Maakt voorboren overbodig en vermindert het risico van splijten van het hout



PerfectPitch®

Optimale schroefdraadspoed voor elke schroeflengte



Uitvoering: HECO-TOPIX-plus T Solar, tellerkop

Aandrijving: T-Drive

Draadtype: onderkopdraad

Materiaal: roestvaststaal A2 1.4567

Oppervlakte: blank, glijcoating

Kleurcode op het HECO-etiket

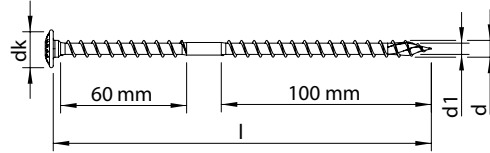

| Afmeting d x l [mm] | Draadlengte lg [mm] | Kopdiameter dk [mm] | Aandrijving | ETA | Artikelnummer | Aantal per verpakking [st.] | Type verpakking | Aantal per omverpakking [st.] | |
|---------------------|---------------------|---------------------|-------------|------|---------------|-----------------------------|-----------------|-------------------------------|-----|
| 8,0 | 240 | 100 | 18,0 | T-40 | • | 61882 | 50 | VARIANTA | 200 |
| | 300 | 100 | 18,0 | T-40 | • | 61897 | 50 | VARIANTA | 200 |
| | 360 | 100 | 18,0 | T-40 | • | 61907 | 50 | VARIANTA | 100 |





HECO-UFIX[®] MDF-schroef

DE OPTIMALE SCHROEF VOOR MDF- EN HDF-PLATEN





HECO-UFIX® MDF-schroef

Product informatie

- Dicht aan de rand schroeven mogelijk
- Vastschroeven aan kopsse kant zonder voorboren
- Vergroot het boorgat door de freesribben op de punt, daardoor wordt de kans op splijtvorming en opbollen vermindert.
- Exact aanzetten zonder weg te glijden op het materiaaloppervlak
- HECO-Drive en aandrijving met GripFit-effect perfect op elkaar afgestemd; de bit wordt vastgeklemd en wankelt niet
- Eén bitmaat voor het complete assortiment

De optimale schroef voor MDF- en HDF-platen

Kleine platverzonken kop met freesholtes

Optimale freeseigenschappen in hout, nauwkeurige bevestiging in het beslag

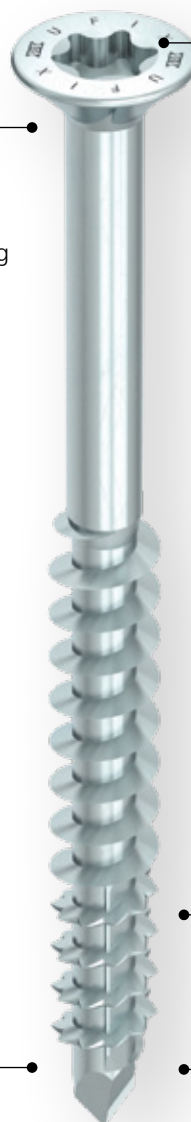

GripFit®

HECO-Drive maakt werken met één hand mogelijk



▶ Video

Vertande schroefdraad

Vermindering van het inschroefmoment

MDF-boorpunt

Makkelijk en snel voorboren

Freesribben aan de punt

Vermindering van het splijtgedrag bij MDF



Uitvoering: MDF-schroef, platverzonken kop met freesholtes

Aandrijving: HECO-Drive*

Draadtype: deeldraad

Materiaal: koolstofstaal

Oppervlakte: verzinkt blauw, A2K **CHROME (VI) FREE +**

Kleurcode op het HECO-etiket

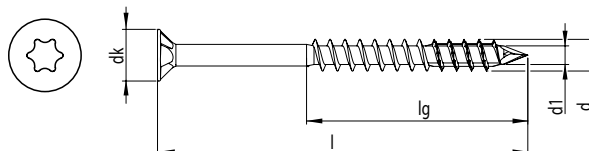

| Afmeting d x l [mm] | Draadlengte lg [mm] | Kopdiameter dk [mm] | Aandrijving | ETA | Artikelnummer | Aantal per verpakking [st.] | Type verpakking | Aantal per omverpakking [st.] |
|---------------------|---------------------|---------------------|-------------|-------|-----------------------|-----------------------------|-----------------|-------------------------------|
| 3,5 ★ | 40 | 28 | 7,0 | HD-20 | 47970 | 200 | SKV | 4000 |
| | 45 | 30 | 7,0 | HD-20 | 47972 | 200 | SKV | 4000 |
| | 50 | 35 | 7,0 | HD-20 | 47974 | 200 | SKV | 4000 |
| 4,0 ★ | 40 | 28 | 7,4 | HD-20 | 47976 | 200 | SKV | 4000 |
| | 45 | 30 | 7,4 | HD-20 | 47978 | 200 | SKV | 4000 |
| | 50 | 35 | 7,4 | HD-20 | 47980 | 200 | SKV | 4000 |
| | 60 | 40 | 7,4 | HD-20 | 47982 | 200 | VARIANTA | 2000 |
| 4,5 ★ | 45 | 30 | 7,9 | HD-20 | 47984 | 200 | SKV | 4000 |
| | 50 | 35 | 7,9 | HD-20 | 47986 | 200 | VARIANTA | 2000 |

* Alle schroeven met HECO-Drive zijn 100% compatibel met conventionele TX-bits.
Het GripFit-effect is alleen gegarandeerd bij gebruik met bijpassende HECO-Drive-bits.

Toepassingsvoorbeelden



Montage van beslag aan kopse kant



Stompe corpusverbindingen



Montage van zwenkwielen





Houtbouw speciaal

SCHROEVEN VOOR DE CONSTRUCTIEVE HOUTBOUW





HECO-WR Speciale voldraadschroef

Product informatie

- Zeer hoog prestatievermogen
- Schroefverbindingen ook parallel tot de vezels mogelijk
- Geen vermindering van het draagvermogen van 90° tot 45° ten opzichte van de vezel
- Verwerking zonder voorboren
- Weinig neiging tot splijten, dus kleine rand- en tussenafstanden
- Tijd- en kostenverlaging
- Breed toepassingspectrum
- Hoge corrosiebescherming (Durocoat)
- CE-markering op basis van ETA-12/0062



Meer power in de constructieve houtbouw

Platverzonken kop



Voldraad

Oppervlakte Durocoat

Ø9 met boorpunt

Ø13 met halve punt

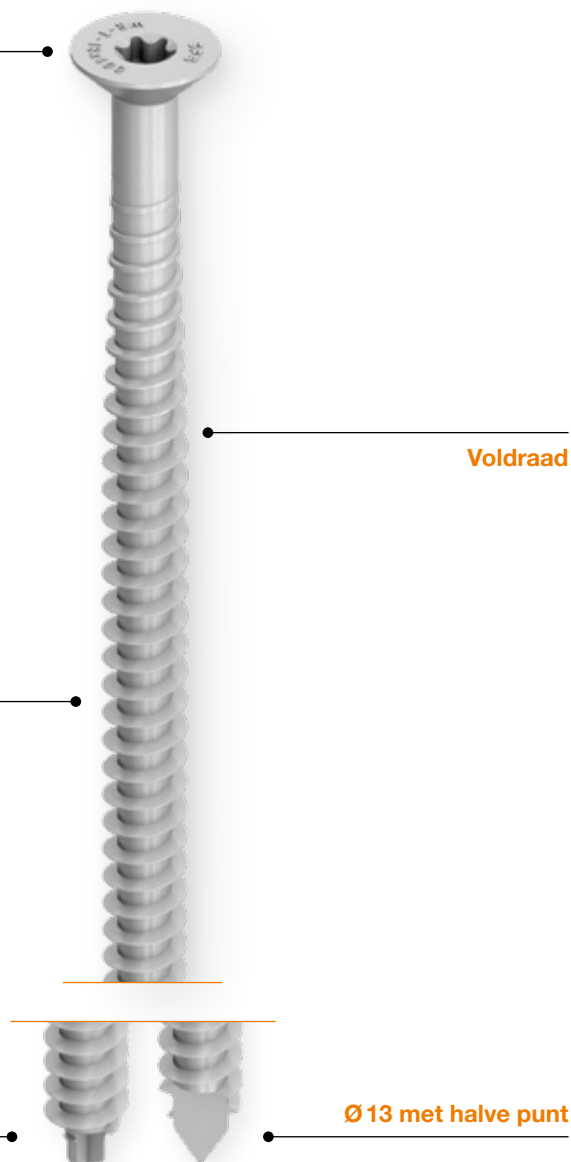

Uitvoering: HECO-WR speciale voldraadschroef, platverzonken kop

Aandrijving: T-Drive

Draadtype: voldraad

Materiaal: koolstofstaal

Oppervlakte: Durocoat **CHROME (VI) FREE +**

Kleurcode op het HECO-etiket

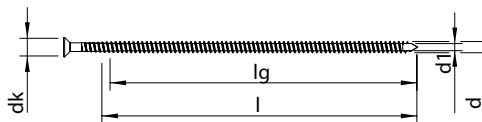

| Afmeting d x l [mm] | Draadlengte lg [mm] | Kopdiameter dk [mm] | Aandrijving | ETA | Artikelnummer | Aantal per verpakking [st.] | Type verpakking | Aantal per omverpakking [st.] |
|---------------------|---------------------|---------------------|-------------|------|---------------|-----------------------------|-----------------|-------------------------------|
| 9,0 | 250 | 230 | 14,0 | T-40 | • 58835 NIEUW | 50 | VARIANTA | 200 |
| | 300 | 280 | 14,0 | T-40 | • 58836 NIEUW | 50 | VARIANTA | 100 |
| | 350 | 330 | 14,0 | T-40 | • 58837 NIEUW | 50 | VARIANTA | 100 |
| | 400 | 380 | 14,0 | T-40 | • 58838 NIEUW | 50 | VARIANTA | 100 |
| | 450 | 430 | 14,0 | T-40 | • 58839 NIEUW | 50 | VARIANTA | 100 |
| | 500 | 480 | 14,0 | T-40 | • 58840 NIEUW | 50 | VARIANTA | 100 |
| 13,0 | 400 | 380 | 22,0 | T-50 | • 53334 | 25 | VARIANTA | 50 |
| | 500 | 480 | 22,0 | T-50 | • 53336 | 25 | VARIANTA | 50 |
| | 600 | 580 | 22,0 | T-50 | • 53337 | 25 | VARIANTA | - |
| | 700 | 680 | 22,0 | T-50 | • 53338 | 25 | VARIANTA | - |
| | 800 | 780 | 22,0 | T-50 | • 53339 | 25 | VARIANTA | - |
| | 900 | 880 | 22,0 | T-50 | • 53340 | 25 | VARIANTA | - |
| | 1000 | 980 | 22,0 | T-50 | • 53341 | 25 | VARIANTA | - |

Het bijbehorende montagegereedschap vindt u op pagina 160

Toepassingsvoorbeelden

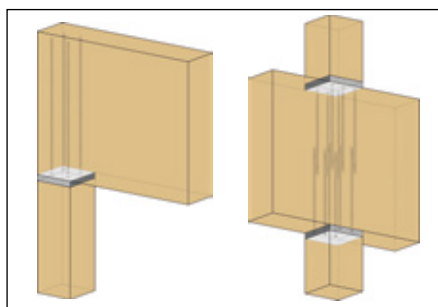

Draagvlakversterking

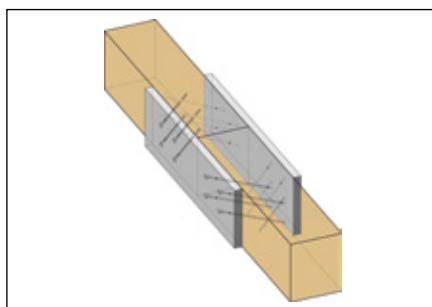

Staalplaten algemeen

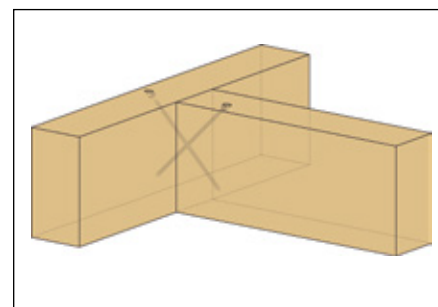

Hoofd-/hulpliggers

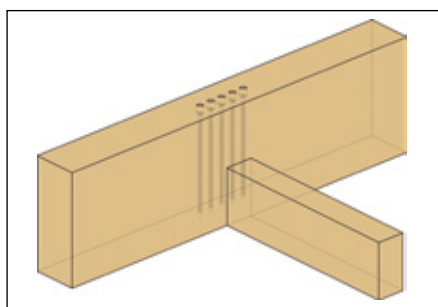

Dwarsversterking

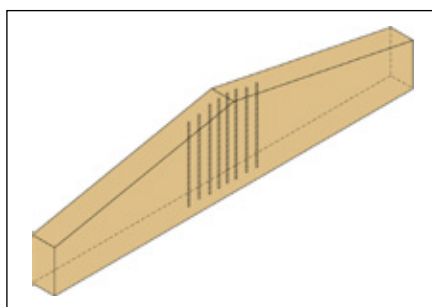

Zadeldaken

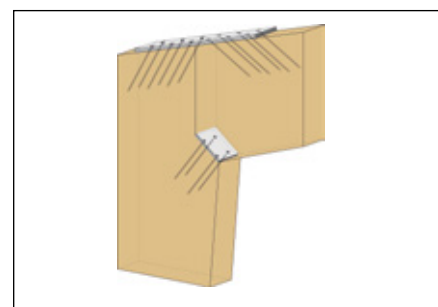

Raamhoeken



HECO-WS Stalen deugel

Product informatie

- Eenvoudig in gebruik zonder voorbereiden van hout en staal
- Zelfborend door de speciale boorpunt
- Geschikt voor talloze toepassingen
- Eenvoudige, betrouwbare berekening volgens EN 1995-1-1
- Hoog vloei-moment $M_{y,k} = 31,93 \text{ Nm}$
- Demonteerbaar
- Fixatie door middel van onderkopdraad
- Hoog brandweerstandsvormogen
- De vormvaste directe schroefverbinding
- Zorgt voor een maximale pasnauwkeurigheid
- Optisch aantrekkelijke verbinding zonder doorbreken van houten oppervlak aan achterkant

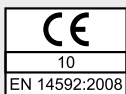

Meer efficiëntie in de houtbouw

Verzonken cilinderkop



Onderkopdraad

Oppervlakte blauw verzinkt

Zelfborend door de speciale boorpunt



Uitvoering: HECO-WS stalen deuvel, verzonken cilinderkop

Aandrijving: T-Drive

Draadtype: onderkopdraad

Materiaal: koolstofstaal

Oppervlakte: verzinkt blauw, A2K **CHROME (VI) FREE +**

Kleurcode op het HECO-etiket

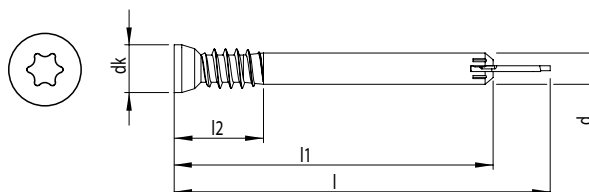
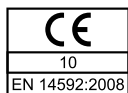

| Afmeting d x l [mm] | Draadlengte lg [mm] | Kopdiameter dk [mm] | Aandrijving | CE | Artikelnummer | Aantal per verpakking [st.] | Type verpakking | Aantal per omverpakking [st.] | |
|---------------------|---------------------|---------------------|-------------|------|---------------|-----------------------------|-----------------|-------------------------------|-----|
| 7,0 | 73 | 14 | 10,7 | T-40 | ● | 53342 | 100 | VARIANTA | 400 |
| | 93 | 14 | 10,7 | T-40 | ● | 53344 | 100 | VARIANTA | 400 |
| | 113 | 14 | 10,7 | T-40 | ● | 53346 | 100 | VARIANTA | 400 |
| | 133 | 14 | 10,7 | T-40 | ● | 53347 | 100 | VARIANTA | 400 |
| | 153 | 14 | 10,7 | T-40 | ● | 53348 | 50 | VARIANTA | 200 |
| | 173 | 14 | 10,7 | T-40 | ● | 53349 | 50 | VARIANTA | 200 |
| | 193 | 14 | 10,7 | T-40 | ● | 53350 | 50 | VARIANTA | 200 |
| | 213 | 14 | 10,7 | T-40 | ● | 53351 | 50 | VARIANTA | 200 |
| | 233 | 14 | 10,7 | T-40 | ● | 53352 | 50 | VARIANTA | 100 |

● = CE volgens EN 14592:2008 Het bijbehorende montagegereedschap vindt u op pagina 161

Toepassingsvoorbeelden

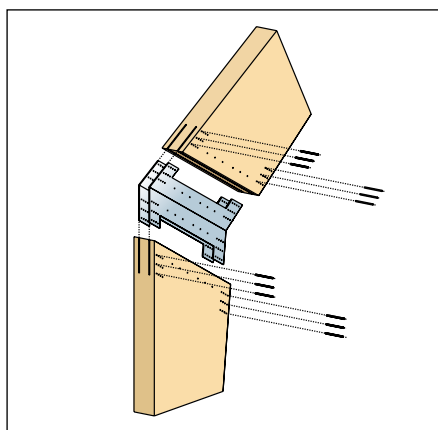

Raamhoek

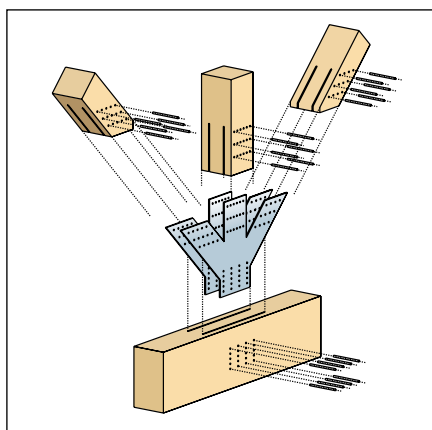

Vakwerk-Knooppunt

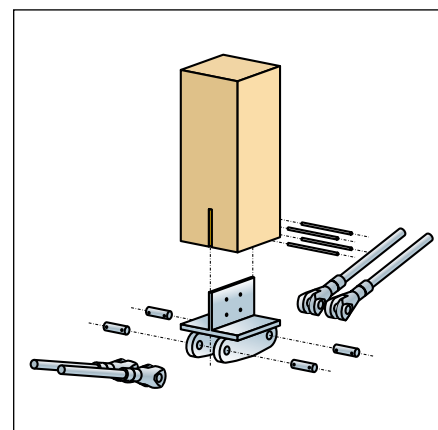

Onderspannen ligger

Andere toepassingen:

- Aansluiting stijl-regel
- Ingespannen paalvoet
- Verbindingen/saneringen
- Knooppunt van steunbalken
- e.a.



HECO-WB Draadstang

Product informatie

- Dwarstrekverstevinging zonder lijm
- Tot wel 50% tijdsbesparing
- Goedgekeurd zonder lijmgebruik
- Ongeacht de temperatuur
- Eenvoudige en veilige berekening
- Hoge trekvastheid 800 N/mm²
- Individueel bijnijden in de lengte mogelijk
- Eenvoudig voorraadbeheer
- Inschroefhuls voor verzinken
- Ook verkrijgbaar als variant met M16-aansluitschroefdraad
- CE-markering op basis van ETA-19/0129



Dwarsverstevingen eenvoudig opgelost

Draadstang zonder kop



Variant met M16-aansluitschroefdraad



Schroefdraadgeometrie
DIN 7998

Oppervlakte blauw verzinkt



Uitvoering: **A** HECO-WB draadstang **B** met M16-aansluitschroefdraad

Aandrijving: montagegereedschap

Draadtype: voldraad

Materiaal: koolstofstaal

Oppervlakte: verzinkt blauw, A2K **CHROME (VI) FREE +**

Kleurcode op het HECO-etiket

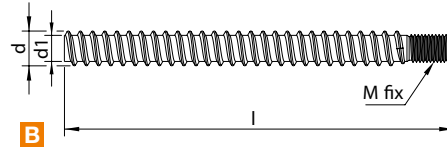
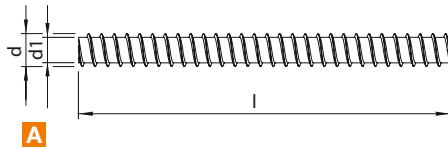

| Afmeting d x l [mm] | Draadlengte lg [mm] | Boorgat-Ø mm] | Aandrijving | ETA | Artikelnummer | Aantal per verpakking [st.] | Type verpakking | Aantal per omverpakking [st.] | |
|---------------------|---------------------|---------------|-------------|-----------|-----------------------------|-----------------------------|-------------------|-------------------------------|---|
| 16,0 | 2.200 | 2.200 | 13,0 | - | A 59138 NIEUW | 1* | Industrieel verp. | - | |
| | ** | ** | 13,0 | - | A 59654 NIEUW | -* | Industrieel verp. | - | |
| 20,0 | 2.200 | 2.200 | 13,0 | - | A 59139 NIEUW | 1* | Industrieel verp. | - | |
| | ** | ** | 16,0 | - | A 59659 NIEUW | -* | Industrieel verp. | - | |
| | 1.000 | 900 | 16,0 | M16 x 100 | - | B 59140 NIEUW | 1* | Industrieel verp. | - |
| | 1.500 | 1.400 | 16,0 | M16 x 100 | - | B 59141 NIEUW | 1* | Industrieel verp. | - |

* Minimale bestelhoeveelheid 5 stuks/snitten ** Individuele lengtesnitten op aanvraag, max. 3.000 mm

Bijpassende accessoires en montagegereedschappen vindt u op pagina's 162 & 163

Toepassingsvoorbeelden

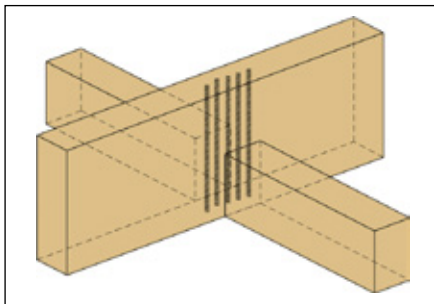

Dwarsaansluitingen

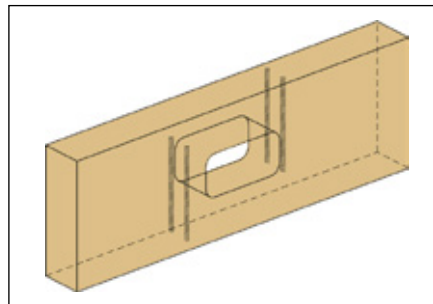

Gaten

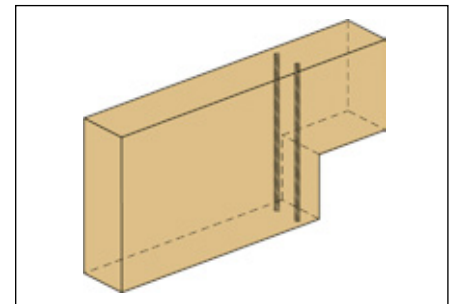

Ontkoppelingen

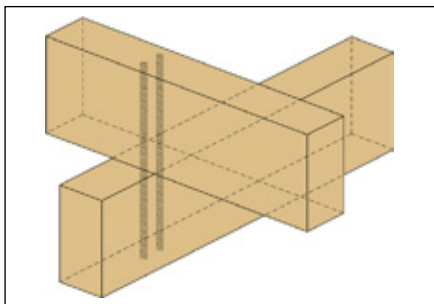

Verbindingen

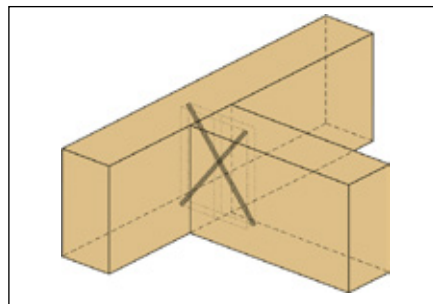

Aansluitingen voor hoofd- en hulpliggers

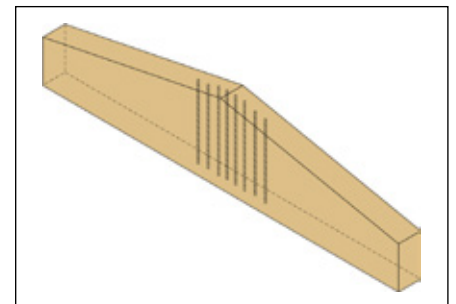

Zadeldakbalken



HECO-VB hout-beton-verbindingsschroef

Product informatie

- Ideaal voor de renovatie van oude gebouwen en nieuwbouw
- Gebruik van bestaande bouwsubstantie
- Minimale ingreep en korte bouwperiode
- Aanzienlijke kostenbesparing vergeleken met conventionele oplossingen
- Groot draagvermogen bij een geringe opbouwhoogte
- Verbetering van de geluidsisolatie
- Verbetering van de brandbeveiliging
- Dimensioneringsbewijzen via HBV-software of dimensionerings-service
- Goedgekeurd en bewaakt product (CE-markering)



De toonaangevende methode bij hout-beton-composietplafonds

Speciale kop

Met TORX-aangrijping E8 voor goede geleiding tijdens de installatie



Kraag

Voor constante en betrouwbare zetdiepte

Schroefdraad

Gering indraaimoment zonder voorbereiden

De HBV-software maakt een efficiënte dimensionering mogelijk



Uitvoering: HECO-VB hout-beton-verbindingsschroef, speciale kop

Aandrijving: buiten-TX E8

Draadtype: deeldraad

Materiaal: koolstofstaal

Oppervlakte: verzinkt blauw, A2K **CHROME (VI) FREE +**

Kleurcode op het HECO-etiket

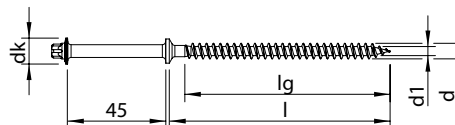

| Afmeting d x l [mm] | Draadlengte lg [mm] | Kopdiameter dk [mm] | Aandrijving | ETA | Artikelnummer | Aantal per verpakking [st.] | Type verpakking | Aantal per omverpakking [st.] |
|---------------------|---------------------|---------------------|-------------|-------|----------------------|-----------------------------|-----------------|-------------------------------|
| 7,5 | 100 | 95 | 12,0 | TX-E8 | • 58841 NIEUW | 100 | VARIANTA | 400 |
| | 165 | 135 | 12,0 | TX-E8 | • 58842 NIEUW | 100 | VARIANTA | 400 |

Het bijbehorende montagegereedschap vindt u op pagina 164

Wij adviseren u graag!
Bel ons gerust:
07422 / 989 – 300

Toepassingsvoorbeelden

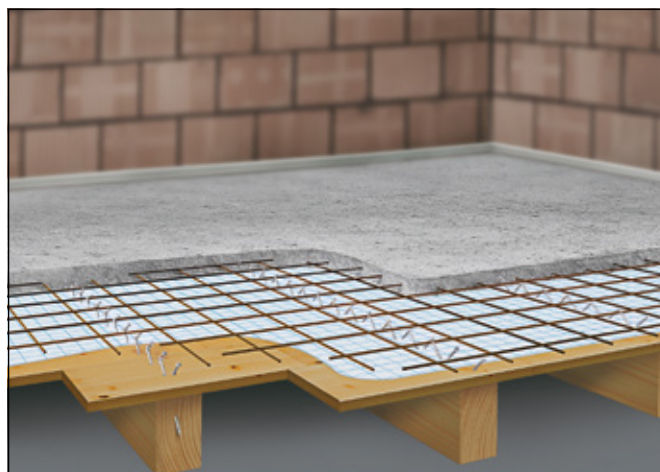
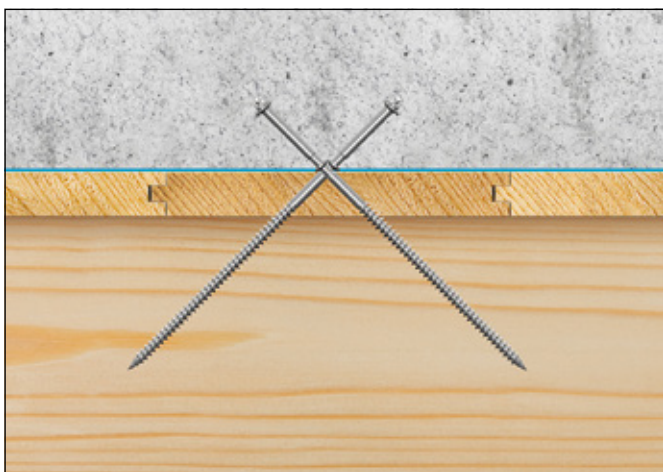

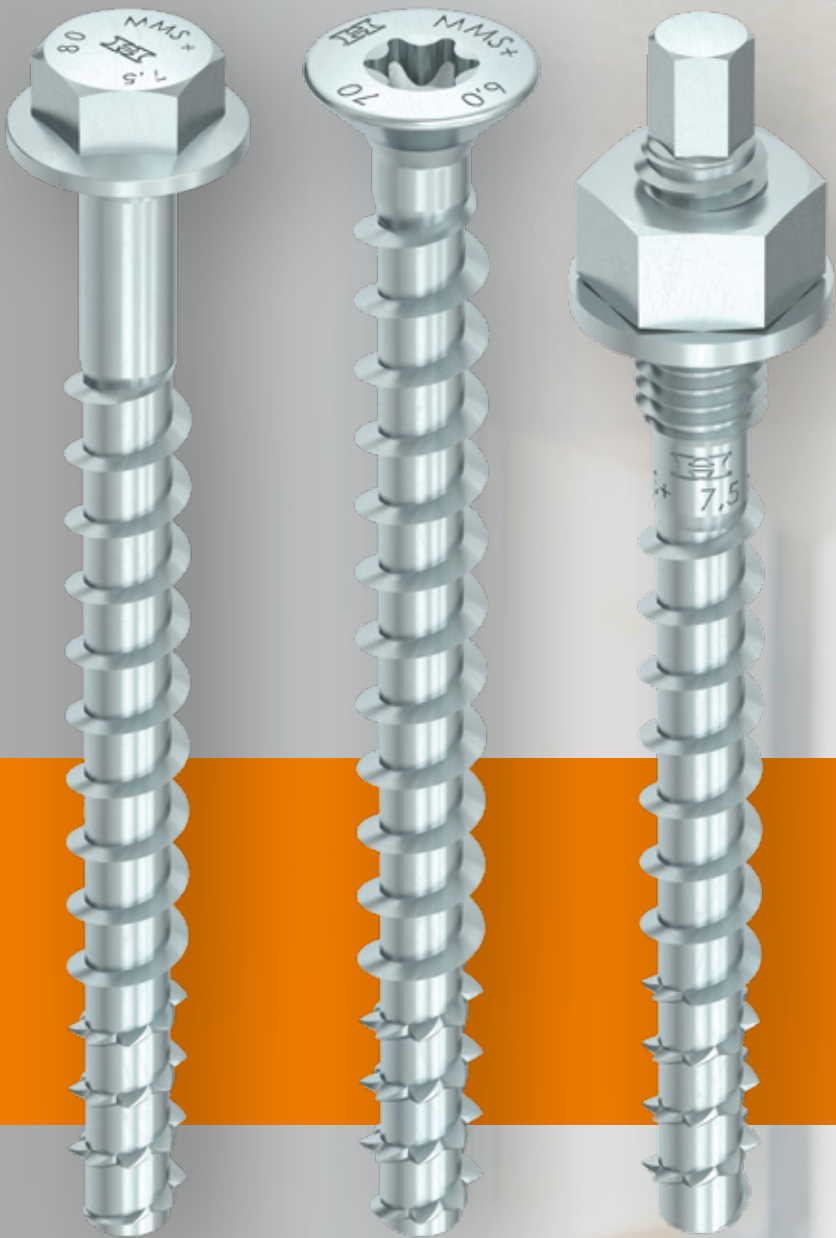



MULTI-MONTI[®]-plus

MEER DAN ALLEEN EEN BETONSCHROEF...
BEVESTIGINGEN IN BETON EN METSELWERK





MULTI-MONTI®-plus Schroefanker

De voordelen in beton

- Montagevriendelijk schroefanker ook bij zwaar versleten boren
- Geoptimaliseerde betondraad met voldraad varianten voor de hoogste eisen
- Tot aan drie montagediepten voor meer flexibiliteit
- Machinaal te monteren en direct belastbaar
- Groter goedgekeurd assortiment voor ETA optie 1 vanaf MMS-plus 6, inclusief seismische lasten vanaf 10 mm

De voordelen in metselwerk

- Met algemene bouwkundige goedkeuring
- Goedgekeurd voor baksteen, massieve kalkzandsteen, holle kalkzandsteen en licht beton
- Toegestaan voor brandbelasting in metselwerk
- Optimale schroefdraad voor veilig en snel bevestigen in metselwerk
- Montage zonder reiniging van het boorgat toegestaan
- Twee zetdieptes voor meer flexibiliteit
- Kan machinaal worden aangebracht, direct belastbaar

Het origineel onder de zelfsnijdende schroefankers voor beton en metselwerk!

Zeskantkop

Met aangepaste schijf en kopstempel MMS+ voor een eenvoudige indentificatie van het anker, ook na montage

MMS-plus schroefdraad

Voor maximale belasting en duurzame constructies



▶ Video



▶ Video

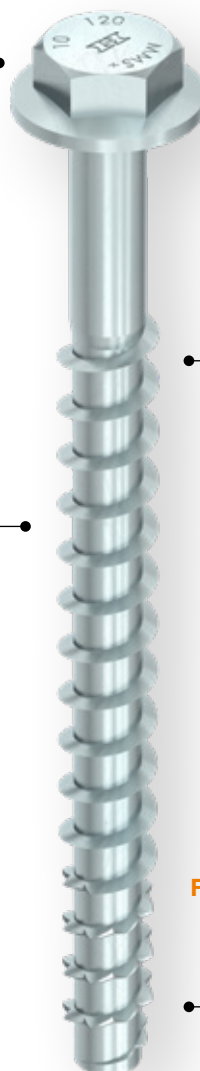

Ideale kern/draad geometrie

Maakt eenvoudig inschroeven en hoge draagkrachten mogelijk

Functionele punt met vertanding

Reduceert slijtage en maakt zo meervoudig gebruik bij tijdelijke bevestigingen mogelijk



Toepassingsvoorbeelden



Montage voor ondersteuning



Buismontage

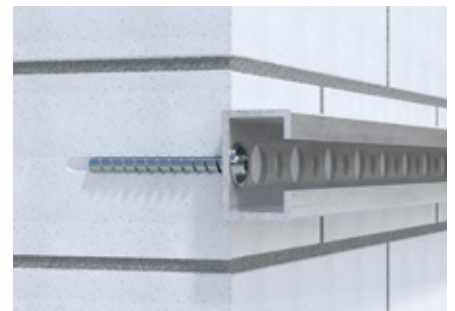

Montage van montagerails



Bevestiging van kabelschachten



Leuningbevestiging



Bevestiging van waterinstallaties



Schoren- en bekistingsmontage

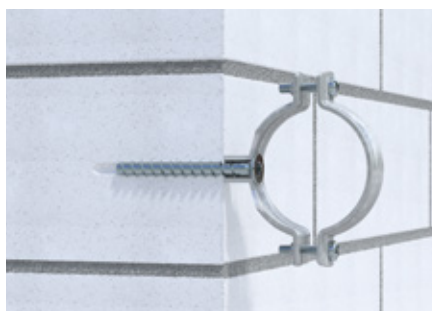

Montage van buisbeugels

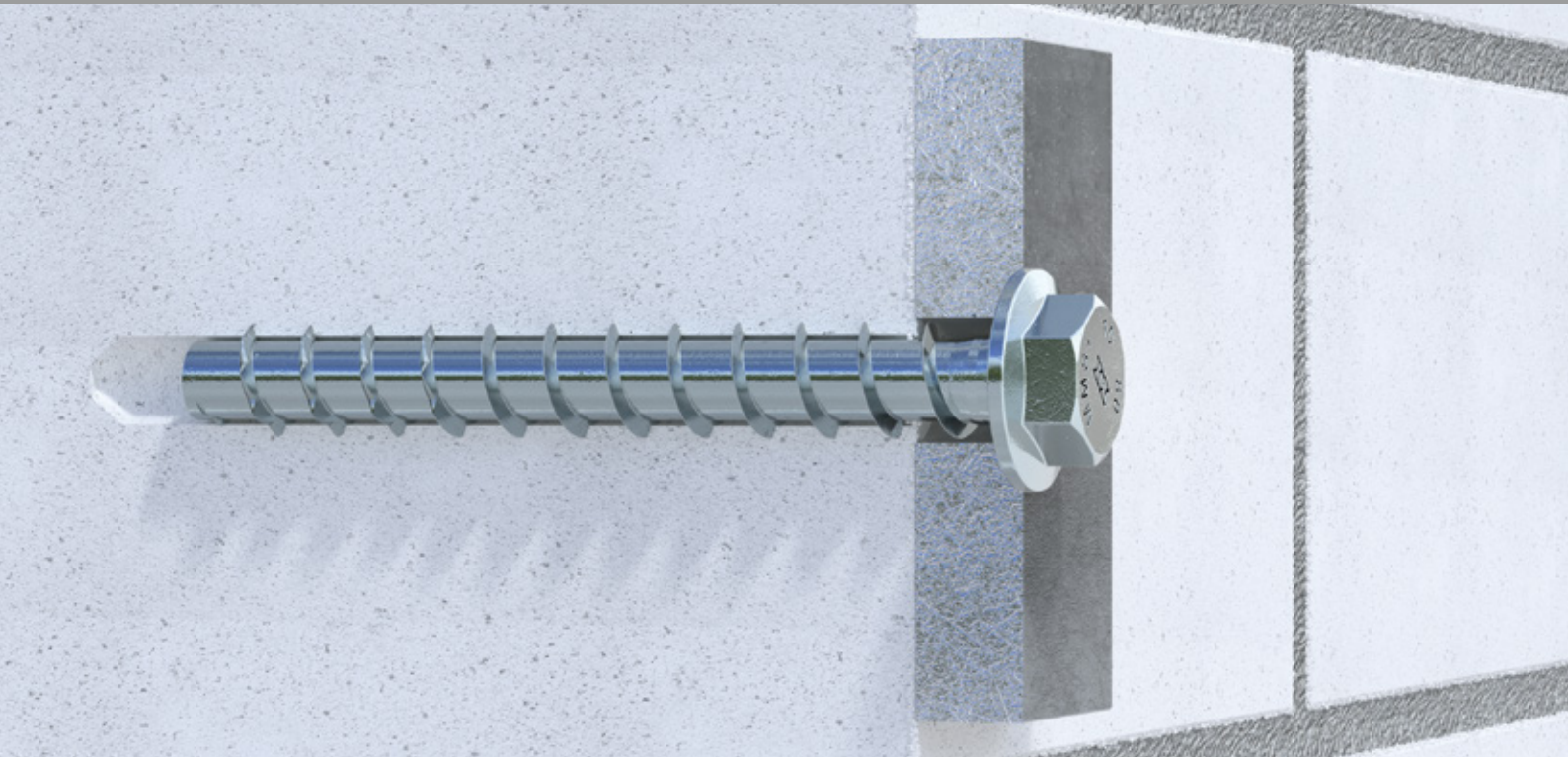

Aanvullende kopuitvoeringen



Platverzonken kop

Voor vlak en correct verzinken



Platte rondkop

Voor de bevestiging van montagerails



Rondkop

Voor het correct aandrukken van een montageonderdeel



Drempelanker

Voor maximaal 245 mm hoge drempels



Stokanker

Met metrisch buitendraad



Voorsteekanker

Met metrisch buitendraad



Binnendraadanker

Met metrisch binnenschroefdraad

132

Goedkeuringen



ETA-05/0010 – Verankering in gescheurd en ongescheurd beton (MULTI-MONTI)



ETA-15/0784 – Verankering in gescheurd en ongescheurd beton (MULTI-MONTI-plus)



ETA-15/0785 – Gebruik in beton voor redundante niet dragende systemen



Z-21.8-2061 – Hergebruik bij tijdelijke bevestigingen in vers beton



Z-21.8-2103 – Verankering in metselwerk, inclusief brandbelasting



Seismische categorie C1 & C2 – geschikt voor regio's met seismische risico's



Brandwerendheidsklasse R120 – in ETA's 15/0784, 15/0785, 05/0010 & Z-21.8-2103



Sprinklerinstallaties – aan eisen van de VdS-richtlijn CEA 4001 wordt voldaan



Z-21.1-1879 – verankering van houten onderdelen in gescheurd en ongescheurd beton



© Kasall GmbH

Voor bevestigingen in beton

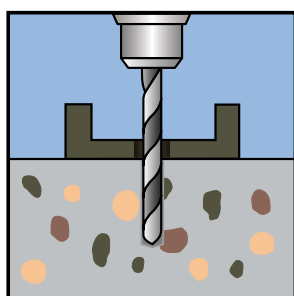

1. Boren

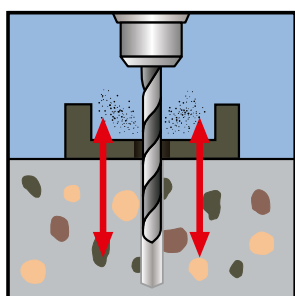

2. Boorgat schoonmaken

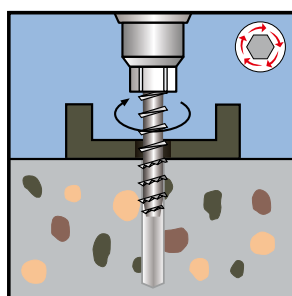

3. Inschroeven

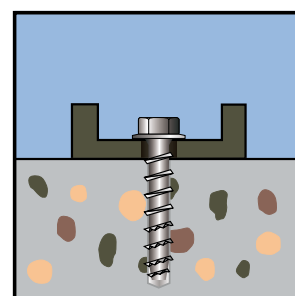

4. Klaar

Voor bevestigingen in metselwerk

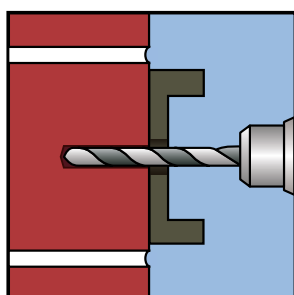

1. Boorgat maken (klopboor)

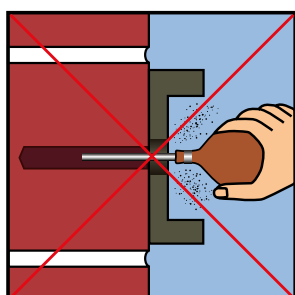

2. Boormeel hoeft niet te worden verwijderd!

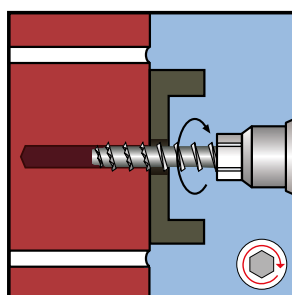

3. Inschroeven (schroefboormachine)

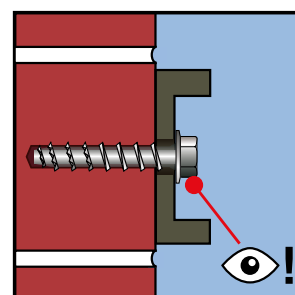

4. Erop letten dat kop goed aansluit → Klaar.



Uitvoering: MMS-plus SS, zeskantkop met aangepaste ring

Aandrijving: zeskantkop

Materiaal: koolstofstaal

Oppervlakte: verzinkt blauw, A2K **CHROME (VI) FREE** +

Kleurcode op het HECO-etiket

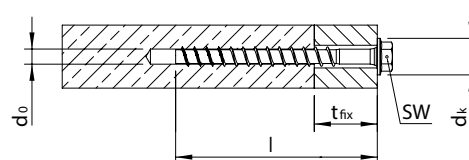

| Afmeting d x l [mm] | Boordiameter d ₀ [mm] | Klemdikte t _{fix} [mm] | Kopdiameter d _k [mm] | Aandrijving | ETA | Artikelnummer | Aantal per verpakking [st.] | Type verpakking | Aantal per omverpakking [st.] | |
|---------------------|----------------------------------|---------------------------------|---------------------------------|-------------|-------|-----------------------|-----------------------------|-----------------|-------------------------------|-------|
| 6,0 | 40 | 5,0 | 5/(15) | 11,0 | SW-8 | ● | 48381 | 100 | VARIANTA | 1.000 |
| | 50 | 5,0 | 5/15/(25) | 11,0 | SW-8 | ● | 48383 | 100 | VARIANTA | 1.000 |
| | 60 | 5,0 | 15/25/(35) | 11,0 | SW-8 | ● | 48385 | 100 | VARIANTA | 1.000 |
| | 70 | 5,0 | 25/35/(45) | 11,0 | SW-8 | ● | 48387 | 100 | VARIANTA | 1.000 |
| | 80 | 5,0 | 35/45/(55) | 11,0 | SW-8 | ● | 49816 | 50 | VARIANTA | 500 |
| 7,5 | 35 | 6,0 | 1/(10) | 14,0 | SW-10 | ● | 49846 | 100 | VARIANTA | 1.000 |
| | 40 | 6,0 | 5/(15) | 14,0 | SW-10 | ● | 48389 | 100 | VARIANTA | 1.000 |
| | 50 | 6,0 | 15/(25) | 14,0 | SW-10 | ● | 48391 | 50 | VARIANTA | 500 |
| | 60 | 6,0 | 5/25/(35) | 14,0 | SW-10 | ● | 48393 | 50 | VARIANTA | 500 |
| | 70 | 6,0 | 15/35/(45) | 14,0 | SW-10 | ● | 48395 | 50 | VARIANTA | 500 |
| | 80 | 6,0 | 25/45/(55) | 14,0 | SW-10 | ● | 48397 | 50 | VARIANTA | 500 |
| | 100 | 6,0 | 45/65/(75) | 14,0 | SW-10 | ● | 49817 | 50 | VARIANTA | 500 |
| | 120 | 6,0 | 65/85/(95) | 14,0 | SW-10 | ● | 49819 | 50 | VARIANTA | 400 |
| 10,0 | 140 | 6,0 | 85/105/(115) | 14,0 | SW-10 | ● | 49821 | 50 | VARIANTA | 400 |
| | 60 | 8,0 | 10 | 19,0 | SW-13 | ● | 48399 | 25 | VARIANTA | 250 |
| | 70 | 8,0 | 5/20 | 19,0 | SW-13 | ● | 48401 | 25 | VARIANTA | 250 |
| | 80 | 8,0 | 15/30 | 19,0 | SW-13 | ● | 48403 | 25 | VARIANTA | 250 |
| | 90 | 8,0 | 25/40 | 19,0 | SW-13 | ● | 48405 | 25 | VARIANTA | 250 |
| | 100 | 8,0 | 35/50 | 19,0 | SW-13 | ● | 48453 | 25 | VARIANTA | 250 |
| | 120 | 8,0 | 55/70 | 19,0 | SW-13 | ● | 48455 | 25 | VARIANTA | 200 |
| | 140 | 8,0 | 75/90 | 19,0 | SW-13 | ● | 48457 | 25 | VARIANTA | 200 |
| 12,0 | 160 | 8,0 | 95/110 | 19,0 | SW-13 | ● | 48459 | 25 | VARIANTA | 200 |
| | 60 | 10,0 | 5 | 22,0 | SW-15 | ● | 54277 | 25 | VARIANTA | 250 |
| | 80 | 10,0 | 5 | 22,0 | SW-15 | ● | 48407 | 25 | VARIANTA | 100 |
| | 90 | 10,0 | 1/15 | 22,0 | SW-15 | ● | 48409 | 25 | VARIANTA | 100 |
| | 100 | 10,0 | 10/25 | 22,0 | SW-15 | ● | 48411 | 25 | VARIANTA | 100 |
| | 120 | 10,0 | 30/45 | 22,0 | SW-15 | ● | 48413 | 25 | VARIANTA | 100 |
| | 140 | 10,0 | 50/65 | 22,0 | SW-15 | ● | 48415 | 25 | VARIANTA | 100 |
| 160 | 10,0 | 70/85 | 22,0 | SW-15 | ● | 48461 | 25 | VARIANTA | 100 | |

* (...) = t_{fix}-waarden tussen haakjes gelden alleen bij het gebruik van de schroeven in redundante, niet-dragende systemen (zie ETA-15/0785)

¹ Geldt alleen voor varianten met diameter 10–12 mm ² Geldt alleen voor varianten met diameter 6–10 mm

Uitvoering: MMS-SS, zeskantkop met aangepaste ring

Aandrijving: zeskantkop

Materiaal: koolstofstaal

Oppervlakte: verzinkt blauw, A2K **CHROME (VI) FREE +**

Kleurcode op het HECO-etiket

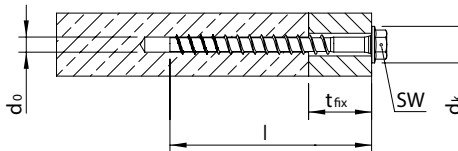

| Afmeting d x l [mm] | Boordiameter d ₀ [mm] | Klemdikte t _{fix} [mm] | Kopdiameter d _k [mm] | Aandrijving | ETA | Artikelnummer | Aantal per verpakking [st.] | Type verpakking | Aantal per omverpakking [st.] | |
|---------------------|----------------------------------|---------------------------------|---------------------------------|-------------|-------|---------------|-----------------------------|-----------------|-------------------------------|-----|
| 14,0 | 110 | 12,0 | 15 | 26,0 | SW-17 | ● | 54271 | 25 | VARIANTA | 100 |
| | 130 | 12,0 | 35 | 26,0 | SW-17 | ● | 54272 | 25 | VARIANTA | 100 |
| | 150 | 12,0 | 55 | 26,0 | SW-17 | ● | 54273 | 25 | VARIANTA | 100 |

Uitvoering: MMS-plus SS, zeskantkop met aangepaste ring

Aandrijving: zeskantkop

Materiaal: koolstofstaal

Oppervlakte: HP-coating **CHROME (VI) FREE +**

Kleurcode op het HECO-etiket

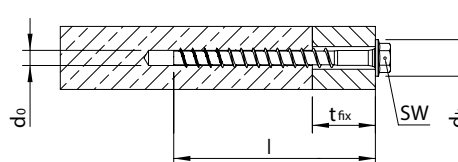

| Afmeting d x l [mm] | Boordiameter d ₀ [mm] | Klemdikte t _{fix} [mm] | Kopdiameter d _k [mm] | Aandrijving | ETA | Artikelnummer | Aantal per verpakking [st.] | Type verpakking | Aantal per omverpakking [st.] | |
|---------------------|----------------------------------|---------------------------------|---------------------------------|-------------|-------|---------------|-----------------------------|-----------------|-------------------------------|-------|
| 6,0 | 50 | 5,0 | 5/15/(25) | 11,0 | SW-8 | ● | 48429 | 100 | VARIANTA | 1.000 |
| | 60 | 5,0 | 15/25/(35) | 11,0 | SW-8 | ● | 48431 | 100 | VARIANTA | 1.000 |
| 7,5 | 50 | 6,0 | 15/(25) | 14,0 | SW-10 | ● | 48433 | 50 | VARIANTA | 500 |
| | 60 | 6,0 | 5/25/(35) | 14,0 | SW-10 | ● | 48435 | 50 | VARIANTA | 500 |
| | 70 | 6,0 | 15/35/(45) | 14,0 | SW-10 | ● | 48437 | 50 | VARIANTA | 500 |
| 10,0 | 60 | 8,0 | 10 | 19,0 | SW-13 | ● | 48439 | 25 | VARIANTA | 250 |
| | 70 | 8,0 | 5/20 | 19,0 | SW-13 | ● | 48441 | 25 | VARIANTA | 250 |
| | 80 | 8,0 | 15/30 | 19,0 | SW-13 | ● | 48443 | 25 | VARIANTA | 250 |
| | 90 | 8,0 | 25/40 | 19,0 | SW-13 | ● | 48445 | 25 | VARIANTA | 250 |
| 12,0 | 90 | 10,0 | 1/15 | 22,0 | SW-15 | ● | 48447 | 25 | VARIANTA | 100 |
| | 100 | 10,0 | 10/25 | 22,0 | SW-15 | ● | 48449 | 25 | VARIANTA | 100 |
| | 120 | 10,0 | 30/45 | 22,0 | SW-15 | ● | 48451 | 25 | VARIANTA | 100 |

* (...) = t_{fix}-waarden tussen haakjes gelden alleen bij het gebruik van de schroeven in redundante, niet-dragende systemen (zie ETA-15/0785)

¹ Geldt alleen voor varianten met diameter 10–12 mm ² Geldt alleen voor varianten met diameter 6–10 mm



Uitvoering: MMS-plus S zwaarlastanker, zeskantkop

Aandrijving: zeskantkop

Materiaal: koolstofstaal

Oppervlakte: verzinkt blauw, A2K **CHROME (VI) FREE +**

Kleurcode op het HECO-etiket

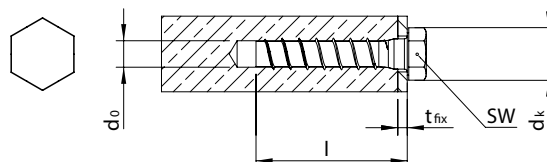

| Afmeting d x l [mm] | Boordiameter d ₀ [mm] | Klemdikte t _{fix} [mm] | Kopdiameter d _k [mm] | Aandrijving | ETA | Artikelnummer | Aantal per verpakking [st.] | Type verpakking | Aantal per omverpakking [st.] |
|---------------------|----------------------------------|---------------------------------|---------------------------------|-------------|-------|---------------|-----------------------------|-----------------|-------------------------------|
| 16,0 | 80 | 14,0 | 5 | 24,0 | SW-24 | 54274 | 25 | VARIANTA | 100 |



Uitvoering: MMS-plus SS zwaarlastanker, zeskantkop met aangepaste ring

Aandrijving: zeskantkop

Materiaal: koolstofstaal

Oppervlakte: verzinkt blauw, A2K **CHROME (VI) FREE +**

Kleurcode op het HECO-etiket

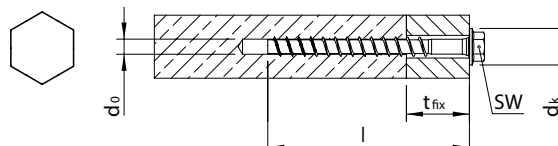

| Afmeting d x l [mm] | Boordiameter d ₀ [mm] | Klemdikte t _{fix} [mm] | Kopdiameter d _k [mm] | Aandrijving | ETA | Artikelnummer | Aantal per verpakking [st.] | Type verpakking | Aantal per omverpakking [st.] |
|---------------------|----------------------------------|---------------------------------|---------------------------------|-------------|-------|---------------|-----------------------------|-----------------|-------------------------------|
| 16,0 | 120 | 14,0 | 5/20 | 30,0 | SW-21 | • 49848 | 10 | VARIANTA | 40 |
| | 130 | 14,0 | 15/30 | 30,0 | SW-21 | • 48417 | 10 | VARIANTA | 40 |
| | 140 | 14,0 | 25/40 | 30,0 | SW-21 | • 48419 | 10 | VARIANTA | 40 |
| | 160 | 14,0 | 45/60 | 30,0 | SW-21 | • 48421 | 10 | VARIANTA | 40 |
| 20,0 | 100 | 18,0 | 10 | 38,0 | SW-24 | • 54275 | 10 | VARIANTA | 40 |
| | 130 | 18,0 | 15 | 38,0 | SW-24 | • 54276 | 10 | VARIANTA | 40 |
| | 160 | 18,0 | 20 | 38,0 | SW-24 | • 48423 | 6 | VARIANTA | 24 |
| | 180 | 18,0 | 40 | 38,0 | SW-24 | • 48425 | 6 | VARIANTA | 24 |
| | 200 | 18,0 | 60 | 38,0 | SW-24 | • 48427 | 6 | VARIANTA | 24 |

Uitvoering: MMS-plus S drempelanker, zeskantkop met sluitring DIN 440

Aandrijving: zeskantkop

Materiaal: koolstofstaal

Oppervlakte: verzinkt blauw, A2K **CHROME (VI) FREE +**

Kleurcode op het HECO-etiket

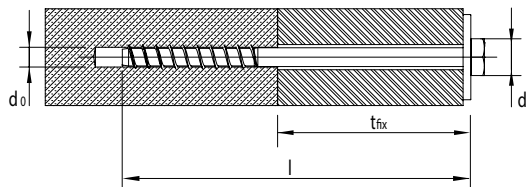

| Afmeting d x l [mm] | Boordiameter d ₀ [mm] | Klemdikte t _{fix} [mm] | Ringdiameter [mm] | Aandrijving | ETA | Artikelnummer | Aantal per verpakking [st.] | Type verpakking | Aantal per omverpakking [st.] |
|---------------------|----------------------------------|---------------------------------|-------------------|-------------|-------|-------------------------|-----------------------------|-----------------|-------------------------------|
| 12,0 | 180 | 10,0 | 90/105 | 43,5 | SW-19 | ● 48463 | 25 | VARIANTA | 50 |
| | 200 | 10,0 | 110/125 | 43,5 | SW-19 | ● 48465 | 25 | VARIANTA | 50 |
| | 240 | 10,0 | 150/165 | 43,5 | SW-19 | ● 48467 | 25 | VARIANTA | 50 |
| | 280 | 10,0 | 190/205 | 43,5 | SW-19 | ● 48469 | 25 | VARIANTA | 50 |
| | 320 | 10,0 | 230/245 | 43,5 | SW-19 | ● 48471 | 25 | VARIANTA | 50 |



Uitvoering: MMS-plus V, voorsteekanker met metrisch buitendraad

Aandrijving: zeskantkop

Materiaal: koolstofstaal

Oppervlakte: verzinkt blauw, A2K **CHROME (VI) FREE +**

Kleurcode op het HECO-etiket

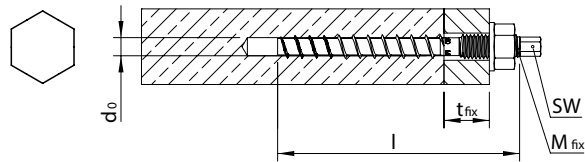

| Afmeting d x l [mm] | Boordiameter d ₀ [mm] | Klemdikte t _{fix} [mm] | Metrisch buitendraad M _{fix} | Aandrijving | ETA | Artikelnummer | Aantal per verpakking [st.] | Type verpakking | Aantal per omverpakking [st.] | |
|---------------------|----------------------------------|---------------------------------|---------------------------------------|-------------|--------|---------------|-----------------------------|-----------------|-------------------------------|-----|
| 7,5 | 80 | 6,0 | 15/35/(45) | M8x20 | SW-5,5 | ● | 48668 | 50 | VARIANTA | 500 |
| | 100 | 6,0 | 35/55/(65) | M8x40 | SW-5,5 | ● | 48670 | 50 | VARIANTA | 500 |
| 10,0 | 90 | 8,0 | 15/30 | M10x20 | SW-7 | ● | 48672 | 25 | VARIANTA | 250 |
| | 110 | 8,0 | 35/50 | M10x40 | SW-7 | ● | 48674 | 25 | VARIANTA | 250 |
| | 130 | 8,0 | 55/70 | M10x60 | SW-7 | ● | 48676 | 25 | VARIANTA | 200 |
| 12,0 | 110 | 10,0 | 20 | M12x30 | SW-8 | ● | 48678 | 25 | VARIANTA | 100 |
| | 120 | 10,0 | 15/30 | M12x25 | SW-8 | ● | 48680 | 25 | VARIANTA | 100 |
| | 140 | 10,0 | 35/50 | M12x45 | SW-8 | ● | 48682 | 25 | VARIANTA | 100 |

* (...) = t_{fix}-waarden tussen haakjes gelden alleen bij het gebruik van de schroeven in redundante, niet-dragende systemen (zie ETA-15/0785)

¹ Geldt alleen voor varianten met diameter 10–12 mm ² Geldt alleen voor varianten met diameter 6–10 mm



Uitvoering: MMS-plus V, zwaarlast-voorsteekanker met metrisch buitendraad

Aandrijving: zeskantkop

Materiaal: koolstofstaal

Oppervlakte: verzinkt blauw, A2K **CHROME (VI) FREE +**

Kleurcode op het HECO-etiket

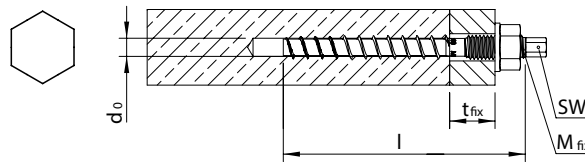
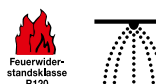

| Afmeting d x l [mm] | Boordiameter d ₀ [mm] | Klemdikte t _{fix} [mm] | Metrisch buitendraad M _{fix} | Aandrijving | ETA | Artikelnummer | Aantal per verpakking [st.] | Type verpakking | Aantal per omverpakking [st.] | |
|---------------------|----------------------------------|---------------------------------|---------------------------------------|-------------|-------|---------------|-----------------------------|-----------------|-------------------------------|----|
| 16,0 | 150 | 14,0 | 20/35 | M16x90 | SW-12 | ● | 48684 | 10 | VARIANTA | 40 |
| | 200 | 14,0 | 70/85 | M16x75 | SW-12 | ● | 48686 | 10 | VARIANTA | 40 |
| 20,0 | 190 | 18,0 | 30 | M20x40 | SW-15 | ● | 48688 | 6 | VARIANTA | 24 |
| | 220 | 18,0 | 60 | M20x70 | SW-15 | ● | 48690 | 6 | VARIANTA | 24 |

Uitvoering: MMS-plus F, platverzonken kop

Aandrijving: T-Drive

Materiaal: koolstofstaal

Oppervlakte: verzinkt blauw, A2K **CHROME (VI) FREE** +

Kleurcode op het HECO-etiket

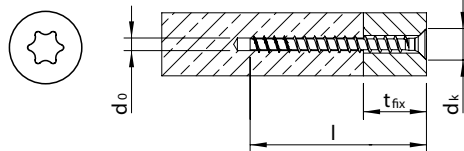

| Afmeting d x l [mm] | Boordiameter d ₀ [mm] | Klemdikte t _{fix} [mm] | Kopdiameter d _k [mm] | Aandrijving | ETA | Artikelnummer | Aantal per verpakking [st.] | Type verpakking | Aantal per omverpakking [st.] | |
|---------------------|----------------------------------|---------------------------------|---------------------------------|-------------|------|---------------|-----------------------------|-----------------|-------------------------------|-------|
| 5,0 ★ | 30 | 4,0 | 1 | 8,7 | T-25 | | 54264 | 200 | VARIANTA | 2.000 |
| | 40 | 4,0 | 5 | 8,7 | T-25 | | 54265 | 200 | VARIANTA | 2.000 |
| | 50 | 4,0 | 15 | 8,7 | T-25 | | 54266 | 200 | VARIANTA | 2.000 |
| | 60 | 4,0 | 25 | 8,7 | T-25 | | 54267 | 200 | VARIANTA | 2.000 |
| 6,0 ★ | 40 | 5,0 | 5/(15) | 11,5 | T-30 | ● | 49860 | 100 | VARIANTA | 1.000 |
| | 50 | 5,0 | 5/15/(25) | 11,5 | T-30 | ● | 48495 | 100 | VARIANTA | 1.000 |
| | 60 | 5,0 | 15/25/(35) | 11,5 | T-30 | ● | 48497 | 100 | VARIANTA | 1.000 |
| | 70 | 5,0 | 25/35/(45) | 11,5 | T-30 | ● | 48499 | 100 | VARIANTA | 1.000 |
| | 80 | 5,0 | 35/45/(55) | 11,5 | T-30 | ● | 48501 | 50 | VARIANTA | 500 |
| | 100 | 5,0 | 55/65/(75) | 11,5 | T-30 | ● | 48503 | 50 | VARIANTA | 500 |
| | 120 | 5,0 | 75/85/(95) | 11,5 | T-30 | ● | 48505 | 50 | VARIANTA | 500 |
| | 140 | 5,0 | 95/105/(115) | 11,5 | T-30 | ● | 48507 | 50 | VARIANTA | 500 |
| 7,5 ★ | 45 | 6,0 | 10/(20) | 15,5 | T-40 | ● | 49862 | 100 | VARIANTA | 1.000 |
| | 50 | 6,0 | 15/(25) | 15,5 | T-40 | ● | 48509 | 100 | VARIANTA | 1.000 |
| | 60 | 6,0 | 5/25/(35) | 15,5 | T-40 | ● | 48511 | 50 | VARIANTA | 500 |
| | 70 | 6,0 | 15/35/(45) | 15,5 | T-40 | ● | 48513 | 50 | VARIANTA | 500 |
| | 80 | 6,0 | 25/45/(55) | 15,5 | T-40 | ● | 48515 | 50 | VARIANTA | 500 |
| | 100 | 6,0 | 45/65/(75) | 15,5 | T-40 | ● | 48517 | 50 | VARIANTA | 500 |
| | 120 | 6,0 | 65/85/(95) | 15,5 | T-40 | ● | 48519 | 50 | VARIANTA | 400 |
| | 140 | 6,0 | 85/105/(115) | 15,5 | T-40 | ● | 48521 | 50 | VARIANTA | 400 |
| | 160 | 6,0 | 105/125/(135) | 15,5 | T-40 | ● | 48523 | 50 | VARIANTA | 400 |
| 10,0 ★ | 60 | 8,0 | 10 | 19,5 | T-45 | ● | 48525 | 25 | VARIANTA | 250 |
| | 70 | 8,0 | 5/20 | 19,5 | T-45 | ● | 48527 | 25 | VARIANTA | 250 |
| | 80 | 8,0 | 15/30 | 19,5 | T-45 | ● | 48529 | 25 | VARIANTA | 250 |
| 12,0 ★ | 90 | 10,0 | 15 | 24,0 | T-50 | ● | 48531 | 25 | VARIANTA | 100 |
| | 100 | 10,0 | 10/25 | 24,0 | T-50 | ● | 48533 | 25 | VARIANTA | 100 |
| | 120 | 10,0 | 30/45 | 24,0 | T-50 | ● | 48535 | 25 | VARIANTA | 100 |

* (...) = t_{fix}-waarden tussen haakjes gelden alleen bij het gebruik van de schroeven in redundante, niet-dragende systemen (zie ETA-15/0785)

¹ Geldt alleen voor varianten met diameter 10–12 mm ² Geldt alleen voor varianten met diameter 6–10 mm



Uitvoering: MMS-plus MS, montagerailschroef met platte rondkop

Aandrijving: T-Drive

Materiaal: koolstofstaal

Oppervlakte: verzinkt blauw, A2K **CHROME (VI) FREE** +

Kleurcode op het HECO-etiket

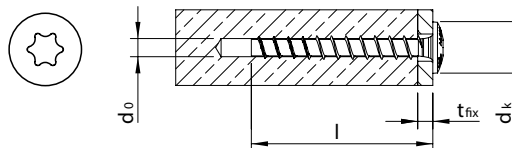

| Afmeting d x l [mm] | Boordiameter d ₀ [mm] | Klemdikte t _{fix} [mm] | Kopdiameter d _k [mm] | Aandrijving | ETA | Artikelnummer | Aantal per verpakking [st.] | Type verpakking | Aantal per omverpakking [st.] | |
|---------------------|----------------------------------|---------------------------------|---------------------------------|-------------|------|---------------|-----------------------------|-----------------|-------------------------------|-------|
| 7,5 ★ | 35 | 6,0 | 1/(10) | 17,0 | T-30 | ● | 49827 | 100 | VARIANTA | 1.000 |
| | 40 | 6,0 | 5/(15) | 17,0 | T-30 | ● | 49854 | 100 | VARIANTA | 1.000 |
| | 45 | 6,0 | 10/(20) | 17,0 | T-30 | ● | 49829 | 100 | VARIANTA | 1.000 |
| | 50 | 6,0 | 15/(25) | 17,0 | T-30 | ● | 49856 | 100 | VARIANTA | 1.000 |
| | 60 | 6,0 | 5/25/(35) | 17,0 | T-30 | ● | 52374 | 50 | VARIANTA | 500 |

* (...) = t_{fix}-waarden tussen haakjes gelden alleen bij het gebruik van de schroeven in redundante, niet-dragende systemen (zie ETA-15/0785)

Uitvoering: MMS-plus ST, stokanker met metr. buitendraad

Aandrijving: zeskantkop

Materiaal: koolstofstaal

Oppervlakte: verzinkt blauw, A2K **CHROME (VI) FREE +**

Kleurcode op het HECO-etiket

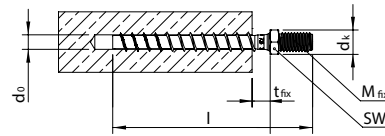

| Afmeting d x l [mm] | Boordiameter d ₀ [mm] | Klemdikte t _{fix} [mm] | Kopdiameter d _k [mm] | Aandrijving | ETA | Artikelnummer | Aantal per verpakking [st.] | Type verpakking | Aantal per omverpakking [st.] | |
|---------------------|----------------------------------|---------------------------------|---------------------------------|-------------|-------|---------------|-----------------------------|-----------------|-------------------------------|-------|
| 6,0 | 55 | 5,0 | 1/10/(20) | 10,0 | SW-10 | ● | 48654 | 100 | VARIANTA | 1.000 |
| | 65 | 5,0 | 10/20/(30) | 10,0 | SW-10 | ● | 48656 | 50 | VARIANTA | 500 |
| 7,5 | 50 | 6,0 | 1/(11) | 10,0 | SW-10 | ● | 57262 | 50 | VARIANTA | 500 |
| | 60 | 6,0 | 8/(18) | 10,0 | SW-10 | ● | 48658 | 50 | VARIANTA | 500 |
| | 70 | 6,0 | 18/(28) | 10,0 | SW-10 | ● | 48660 | 50 | VARIANTA | 500 |
| | 80 | 6,0 | 8/28/(38) | 10,0 | SW-10 | ● | 48662 | 50 | VARIANTA | 500 |
| | 100 | 6,0 | 28/48/(58) | 10,0 | SW-10 | ● | 48664 | 50 | VARIANTA | 500 |
| | 120 | 6,0 | 48/68/(78) | 10,0 | SW-10 | ● | 49831 | 50 | VARIANTA | 400 |
| 10,0 | 75 | 8,0 | 10 | 13,0 | SW-13 | ● | 49858 | 25 | VARIANTA | 250 |
| | 85 | 8,0 | 5/20 | 13,0 | SW-13 | ● | 48666 | 25 | VARIANTA | 250 |

* (...) = t_{fix}-waarden tussen haakjes gelden alleen bij het gebruik van de schroeven in redundante, niet-dragende systemen (zie ETA-15/0785)

¹ Geldt alleen voor varianten met diameter 10 mm

MMS-plus ST 6,0: met metrisch buitendraad M6 x 5 mm

MMS-plus ST 7,5: met metrisch buitendraad M8 x 14 mm

MMS-plus ST 10,0: met metrisch buitendraad M10 x 11 mm



Uitvoering: MMS-plus I, binnendraadanker

Aandrijving: zeskantkop

Materiaal: koolstofstaal

Oppervlakte: verzinkt blauw, A2K **CHROME (VI) FREE** +

Kleurcode op het HECO-etiket

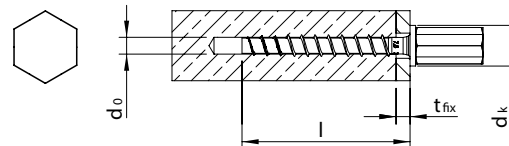

| Afmeting d x l [mm] | Boordiameter d ₀ [mm] | Klemdikte t _{fix} [mm] | Kopdiameter d _k [mm] | Aandrijving | ETA | Artikelnummer | Aantal per verpakking [st.] | Type verpakking | Aantal per omverpakking [st.] | |
|---------------------|----------------------------------|---------------------------------|---------------------------------|-------------|-------|---------------|-----------------------------|-----------------|-------------------------------|-------|
| 6,0 | 40 | 5,0 | 5/(15) | 11,0 | SW-10 | ● | 48692 | 100 | VARIANTA | 1.000 |
| 7,5 | 40 | 6,0 | 5/(15) | 14,5 | SW-13 | ● | 49833 ** | 40 | VARIANTA | 400 |
| | 40 | 6,0 | 5/(15) | 14,5 | SW-13 | ● | 48696 | 50 | VARIANTA | 500 |
| | 60 | 6,0 | 5/25/(35) | 14,5 | SW-13 | ● | 49834 ** | 40 | VARIANTA | 400 |
| | 60 | 6,0 | 5/25/(35) | 14,5 | SW-13 | ● | 48698 | 50 | VARIANTA | 500 |
| 10,0 | 60 | 8,0 | 10 | 19,5 | SW-13 | ● | 48700 | 25 | VARIANTA | 250 |
| | 75 | 8,0 | 10/25 | 19,5 | SW-13 | ● | 48702 | 25 | VARIANTA | 250 |

* (...) = t_{fix}-waarden tussen haakjes gelden alleen bij het gebruik van de schroeven in redundante, niet-dragende systemen (zie ETA-15/0785)

** gecombineerde schroefdraad M8/M10 x 23mm

¹ Geldt alleen voor varianten met diameter 10mm

MMS-plus I 6,0: met metrisch buitendraad M6 x 15mm

MMS-plus I 7,5: met metrisch buitendraad M8 x 12mm

MMS-plus I 10,0: met metrisch buitendraad M10 x 13mm

Uitvoering: MMS-plus P, rondkop

Aandrijving: T-Drive

Materiaal: koolstofstaal

Oppervlakte: verzinkt blauw, A2K **CHROME (VI) FREE** +

Kleurcode op het HECO-etiket

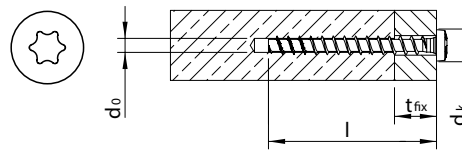

| Afmeting d x l [mm] | Boordiameter d ₀ [mm] | Klemdikte t _{fix} [mm] | Kopdiameter d _k [mm] | Aandrijving | ETA | Artikelnummer | Aantal per verpakking [st.] | Type verpakking | Aantal per omverpakking [st.] | |
|---------------------|----------------------------------|---------------------------------|---------------------------------|-------------|------|---------------|-----------------------------|-----------------|-------------------------------|-------|
| 5,0 | 30 | 4,0 | 1 | 7,9 | T-20 | | 54268 | 200 | VARIANTA | 2.000 |
| | 50 | 4,0 | 15 | 7,9 | T-20 | | 54269 | 200 | VARIANTA | 2.000 |
| 6,0 | 30 | 5,0 | 1/(5) | 11,2 | T-30 | | 54278 | 200 | VARIANTA | 2.000 |
| | 35 | 5,0 | 1/(10) | 11,0 | T-30 | ● | 49850 | 100 | VARIANTA | 1.000 |
| | 40 | 5,0 | 5/(15) | 11,0 | T-30 | ● | 48483 | 100 | VARIANTA | 1.000 |
| | 50 | 5,0 | 5/15/(25) | 11,0 | T-30 | ● | 48485 | 100 | VARIANTA | 1.000 |
| | 60 | 5,0 | 15/25/(35) | 11,0 | T-30 | ● | 48487 | 100 | VARIANTA | 1.000 |
| 7,5 | 25 | 6,0 | 1 | 14,5 | T-30 | | 54279 | 200 | VARIANTA | 2.000 |
| | 35 | 6,0 | 1/(10) | 14,5 | T-30 | ● | 49852 | 100 | VARIANTA | 1.000 |
| | 40 | 6,0 | 5/(15) | 14,5 | T-30 | ● | 48489 | 100 | VARIANTA | 1.000 |
| | 50 | 6,0 | 15/(25) | 14,5 | T-30 | ● | 48491 | 100 | VARIANTA | 500 |
| | 60 | 6,0 | 5/25/(35) | 14,5 | T-30 | ● | 48493 | 50 | VARIANTA | 500 |
| 10,0 | 60 | 8,0 | 10 | 19,5 | T-40 | ● | 49823 | 25 | VARIANTA | 250 |
| | 70 | 8,0 | 5/20 | 19,5 | T-40 | ● | 49825 | 25 | VARIANTA | 250 |

* (...) = t_{fix}-waarden tussen haakjes gelden alleen bij het gebruik van de schroeven in redundante, niet-dragende systemen (zie ETA-15/0785)

¹ Geldt alleen voor varianten met diameter 10 mm



Uitvoering: MMS-plus KS, kabelklemschroef

Aandrijving: T-Drive

Materiaal: koolstofstaal

Oppervlakte: verzinkt blauw, A2K **CHROME (VI) FREE +**

Kleurcode op het HECO-etiket

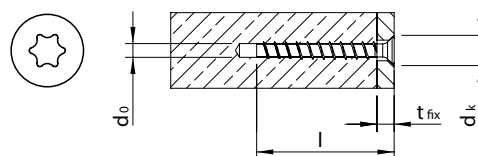

| Afmeting d x l [mm] | Boordiameter d ₀ [mm] | Klemdikte t _{fix} [mm] | Kopdiameter d _k [mm] | Aandrijving | ETA | Artikelnummer | Aantal per verpakking [st.] | Type verpakking | Aantal per omverpakking [st.] |
|---------------------|----------------------------------|---------------------------------|---------------------------------|-------------|-----|---------------|-----------------------------|-----------------|-------------------------------|
| 5,0 ¹ | 40 | 4,0 | 7,8 | T-20 | | 54270 | 200 | VARIANTA | 2.000 |

¹ Kleurcodering T-20-Bit =



Uitvoering: MMS-plus R, ooganker*

Aandrijving: montagegereedschap*

Materiaal: koolstofstaal

Oppervlakte: verzinkt blauw, A2K **CHROME (VI) FREE +**

Kleurcode op het HECO-etiket

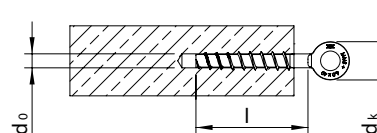

| Afmeting d x l [mm] | Boordiameter d ₀ [mm] | Klemdikte t _{fix} [mm] | Kopdiameter d _k [mm] | Aandrijving | ETA | Artikelnummer | Aantal per verpakking [st.] | Type verpakking | Aantal per omverpakking [st.] |
|---------------------|----------------------------------|---------------------------------|---------------------------------|-------------|-----|---------------|-----------------------------|-----------------|-------------------------------|
| 6,0 | 40 | 5,0 | 14,0 | - | | 54280 | 200 | VARIANTA | 2.000 |

* Zetgereedschap is bijgevoegd

Uitvoering: MMS-TC TimberConnect

Aandrijving: T-Drive

Materiaal: koolstofstaal

Oppervlakte: verzinkt blauw, A2K **CHROME (VI) FREE** +

Kleurcode op het HECO-etiket

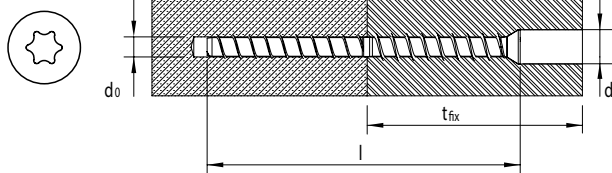

| Afmeting d x l [mm] | Boordiameter d ₀ [mm] | Klemdikte t _{fix} [mm] | Kopdiameter d _k [mm] | Aandrijving | Toelating | Artikelnummer | Aantal per verpakking [st.] | Type verpakking | Aantal per omverpakking [st.] |
|-------------------------|----------------------------------|---------------------------------|---------------------------------|-------------|-----------|-----------------------|-----------------------------|-----------------|-------------------------------|
| 7,5¹ | 100 | 6,0 | 40–140 | T-30 | ● | 48308 | 50 | VARIANTA | 500 |
| 10,0² | 130 | 8,0 | 60–200 | T-45 | ● | 48310 | 25 | VARIANTA | 250 |
| 12,0³ | 160 | 10,0 | 80–300 | T-50 | ● | 48312 | 25 | VARIANTA | 100 |

Het bijbehorende zetgereedschap vindt u op pagina 165

¹ Kleurcodering T-30-Bit = ● ² Kleurcodering T-45-Bit = ● ³ Kleurcodering T-50-Bit = ●

De juiste montage

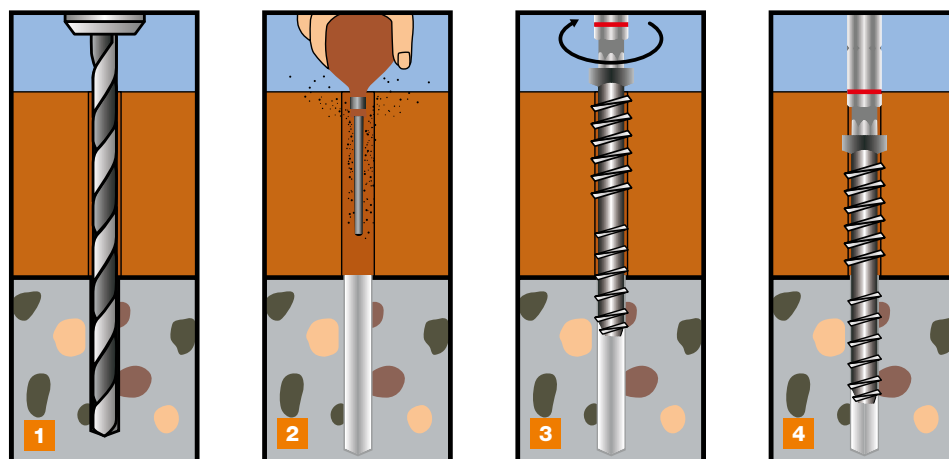

1. Boren

2. Boorgat schoonmaken

3. Inschroeven

4. Klaar



▶ Video



MULTI-MONTI®-plus SSK

Product informatie

- Tijdelijke bevestiging van bouwplaatsinrichtingen zoals bijv. bouwstempels, schoren, valbeveiliging en steigerbouw
- Demonteerbaar en herbruikbaar met gebruik van een meethuls
- Goedgekeurd voor gebruik in jong beton bij een betondruksterkte $f_{c,cube} > 10 \text{ N/mm}^2$
- Gatdiameter van 17 – 23 mm in de grondplaat met één schroef herbruikbaar
- Machinaal zetbaar, geen specifiek aandraaimoment nodig
- Geen spreiddruk
- Veilig in gebruik, geen verborgen montagefouten mogelijk
- Goedgekeurd en bewaakt product



Het innovatieve schroefanker voor bevestiging van schoren in jong beton

Kopstempeling

Voor een eenvoudige indentificatie van het anker, ook na montage

Conus onder de kop

Past zich aan verschillende gatdiameters aan

Ideale kern/ schroefdraad geometrie

Maakt eenvoudig inschroeven en hoge draagkrachten mogelijk

Vertande functionele punt

Reduceert slijtage door de grotere buitendiameter en de versterkte vertanding

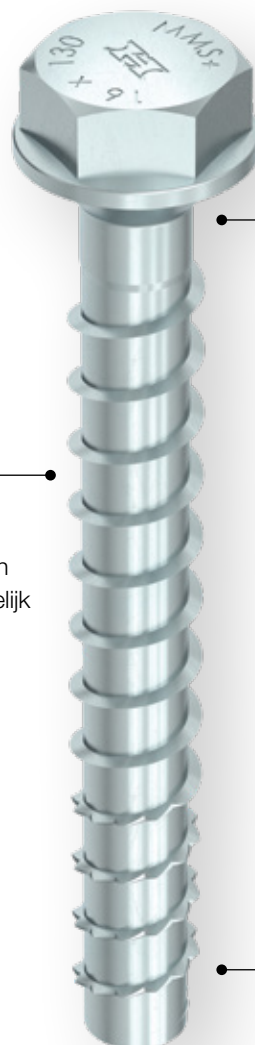

Uitvoering: MMS-plus SSK, zeskantkop met aangepaste ring en conus

Aandrijving: zeskantkop

Materiaal: koolstofstaal

Oppervlakte: verzinkt blauw, A2K **CHROME (VI) FREE +**

Kleurcode op het HECO-etiket

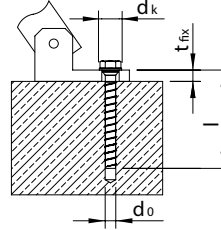
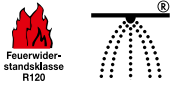

| Afmeting d x l [mm] | Boordiameter do [mm] | Klemdikte t _{fix} [mm] | Kopdiameter d _k [mm] | Aandrijving | ETA | Artikelnummer | Aantal per verpakking [st.] | Type verpakking | Aantal per omverpakking [st.] |
|---------------------|----------------------|---------------------------------|---------------------------------|-------------|-------|---------------|-----------------------------|-----------------|-------------------------------|
| 16,0 | 90 | 14,0 | 15 | 30,0 | SW-24 | 57286 | 10 | VARIANTA | 40 |
| | 130 | 14,0 | 15/30 | 30,0 | SW-24 | 53794 | 10 | VARIANTA | 40 |

Het bijbehorende meethulzen vindt u op pagina 166

Herbruikbaarheidstest



Dankzij de **HECO-meethulzen** (artikelnummer 47794) met **diameter 16**, kan de schroef bij tijdelijke bevestigingen altijd op de herbruikbaarheid getest worden.

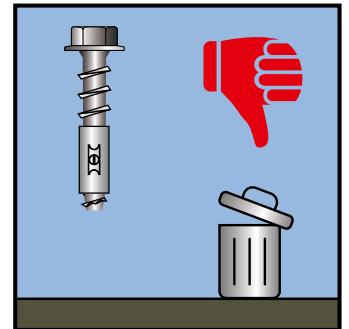
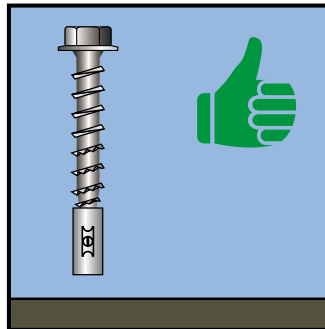



MULTI-MONTI®-plus Roestvaststaal

Product informatie

- Het schroefanker met het hoogste montagecomfort
- Geoptimaliseerd betonschroefdraad voor een krachtige verankering
- Tot 6 montage diepten voor maximale flexibiliteit
- Uitgebreid productassortiment voor verschillende toepassingen
- Verkrijgbaar in roestvrij staal A4 1.4401
- Roestvrij staal 1.4529 / HCR op aanvraag
- Goedgekeurd en bewaakt product voor gescheurd en ongescheurd beton



Het innovatieve schroefanker voor beton en metselwerk binnen en buiten

Kopstempeling

Voor eenvoudige identificatie van het anker, ook na de montage

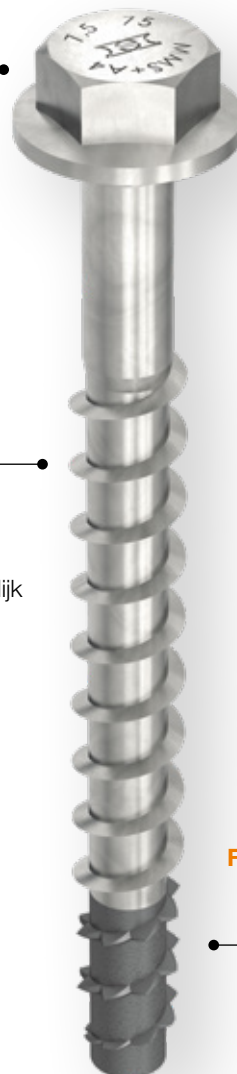

Ideale kern/ schroefdraad geometrie

Maakt eenvoudig inschroeven en hoge draagkrachten mogelijk

Functionele punt gefosfateerd

Voor een zekere achtersnijding in het beton



▶ Video



Uitvoering: MMS-plus SS, zeskantkop met aangepaste ring

Aandrijving: zeskantkop

Materiaal: roestvaststaal A4 1.4401

Oppervlakte: blank, punt gefosfateerd

Kleurcode op het HECO-etiket

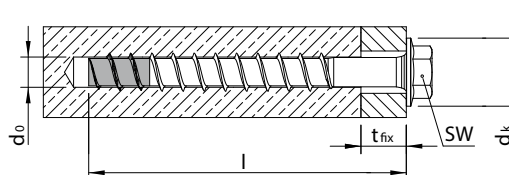

| Afmeting d x l [mm] | Boor-Ø d ₀ [mm] | Klemdikte t _{fix, standard} * [mm] | Klemdikte t _{fix, reduced} * [mm] | Kopdiameter d ₀ [mm] | Aandrijving | ETA | Artikelnummer | Aantal per verpakking [st.] | Type verpakking | Aantal per omverpakking [st.] | |
|---------------------|----------------------------|---|--|---------------------------------|-------------|-------|---------------|-----------------------------|-----------------|-------------------------------|-----|
| 7,5 | 40 | 6,0 | 1 | 5 | 14,5 | SW-10 | ● | 56612 | 50 | VARIANTA | 500 |
| | 45 | 6,0 | 5 | 10 | 14,5 | SW-10 | ● | 52805 | 50 | VARIANTA | 500 |
| | 55 | 6,0 | 1/15 | 5/20 | 14,5 | SW-10 | ● | 56613 | 50 | VARIANTA | 500 |
| | 65 | 6,0 | 10/25 | 1/15/30 | 14,5 | SW-10 | ● | 56616 | 50 | VARIANTA | 500 |
| | 75 | 6,0 | 1/20/35 | 10/25/40 | 14,5 | SW-10 | ● | 52792 | 50 | VARIANTA | 500 |
| | 85 | 6,0 | 10/30/45 | 20/35/50 | 14,5 | SW-10 | ● | 52793 | 50 | VARIANTA | 500 |
| | 105 | 6,0 | 30/50/65 | 40/55/70 | 14,5 | SW-10 | ● | 52794 | 50 | VARIANTA | 500 |
| 10,0 | 65 | 8,0 | - | 5 | 19,5 | SW-13 | ● | 56617 | 25 | VARIANTA | 250 |
| | 75 | 8,0 | 5 | 1/15 | 19,5 | SW-13 | ● | 56618 | 25 | VARIANTA | 250 |
| | 85 | 8,0 | 1/15 | 10/25 | 19,5 | SW-13 | ● | 56619 | 25 | VARIANTA | 250 |
| | 95 | 8,0 | 10/25 | 20/35 | 19,5 | SW-13 | ● | 56620 | 25 | VARIANTA | 250 |
| | 105 | 8,0 | 20/35 | 30/45 | 19,5 | SW-13 | ● | 56621 | 25 | VARIANTA | 250 |
| 12,0 | 95 | 10,0 | - | 5 | 22,5 | SW-15 | ● | 56622 | 25 | VARIANTA | 100 |
| | 105 | 10,0 | 5 | 1/15 | 22,5 | SW-15 | ● | 52801 | 25 | VARIANTA | 100 |
| | 120 | 10,0 | 5/20 | 15/30 | 22,5 | SW-15 | ● | 52802 | 25 | VARIANTA | 100 |
| | 135 | 10,0 | 20/35 | 30/45 | 22,5 | SW-15 | ● | 50252 | 25 | VARIANTA | 100 |

* Klemdikte t_{fix, standard} en t_{fix, reduced} afhankelijk van de opgegeven draagkracht uit de ETA-15/0784



Uitvoering: MMS-plus F, platverzonken kop

Aandrijving: T-Drive

Materiaal: roestvaststaal A4 1.4401

Oppervlakte: blank, punt gefosfateerd

Kleurcode op het HECO-etiket

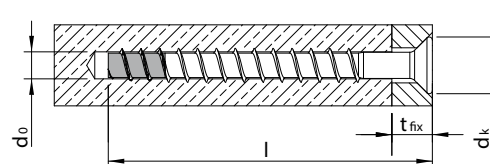

| Afmeting d x l [mm] | Boor-Ø d ₀ [mm] | Klemdikte t _{fix, standard} * [mm] | Klemdikte t _{fix, reduced} * [mm] | Kopdiameter d _k [mm] | Aandrijving | ETA | Artikelnummer | Aantal per verpakking [st.] | Type verpakking | Aantal per omverpakking [st.] | |
|---------------------|----------------------------|---|--|---------------------------------|-------------|------|---------------|-----------------------------|-----------------|-------------------------------|-----|
| 7,5 ★ | 40 | 6,0 | 1 | 5 | 13,6 | T-30 | ● | 56623 | 50 | VARIANTA | 500 |
| | 45 | 6,0 | 5 | 10 | 13,6 | T-30 | ● | 52785 | 50 | VARIANTA | 500 |
| | 55 | 6,0 | 1/15 | 5/20 | 13,6 | T-30 | ● | 56624 | 50 | VARIANTA | 500 |
| | 65 | 6,0 | 10/25 | 1/15/30 | 13,6 | T-30 | ● | 56625 | 50 | VARIANTA | 500 |
| | 75 | 6,0 | 1/20/35 | 10/25/40 | 13,6 | T-30 | ● | 52788 | 50 | VARIANTA | 500 |
| | 85 | 6,0 | 10/30/45 | 20/35/50 | 13,6 | T-30 | ● | 52789 | 50 | VARIANTA | 500 |
| | 95 | 6,0 | 20/40/55 | 30/45/60 | 13,6 | T-30 | ● | 53130 | 50 | VARIANTA | 500 |
| | 105 | 6,0 | 30/50/65 | 40/55/70 | 13,6 | T-30 | ● | 52790 | 50 | VARIANTA | 500 |
| | 125 | 6,0 | 50/70/85 | 60/75/90 | 13,6 | T-30 | ● | 52791 | 50 | VARIANTA | 500 |
| 10,0 ★ | 65 | 8,0 | - | 5 | 17,0 | T-40 | ● | 56626 | 25 | VARIANTA | 250 |
| | 80 | 8,0 | 5/10 | 5/20 | 17,0 | T-40 | ● | 56627 | 25 | VARIANTA | 250 |
| | 90 | 8,0 | 5/20 | 15/30 | 17,0 | T-40 | ● | 56628 | 25 | VARIANTA | 250 |
| | 100 | 8,0 | 15/30 | 25/40 | 17,0 | T-40 | ● | 56629 | 25 | VARIANTA | 250 |
| 12,0 ★ | 95 | 10,0 | - | 5 | 21,0 | T-50 | ● | 56630 | 25 | VARIANTA | 100 |
| | 105 | 10,0 | 5 | 1/15 | 21,0 | T-50 | ● | 56631 | 25 | VARIANTA | 100 |
| | 120 | 10,0 | 5/20 | 15/30 | 21,0 | T-50 | ● | 56632 | 25 | VARIANTA | 100 |
| | 130 | 10,0 | 15/30 | 25/40 | 21,0 | T-50 | ● | 56633 | 25 | VARIANTA | 100 |

* Klemdikte t_{fix, standard} en t_{fix, reduced} afhankelijk van de opgegeven draagkracht uit de ETA-15/0784

Uitvoering: MMS-plus P, rondkop

Aandrijving: T-Drive

Materiaal: roestvaststaal A4 1.4401

Oppervlakte: blank, punt gefosfateerd

Kleurcode op het HECO-etiket

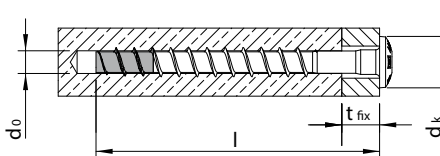

| Afmeting d x l [mm] | Boor-Ø d ₀ [mm] | Klemdikte t _{fix, standard} * [mm] | Klemdikte t _{fix, reduced} * [mm] | Kopdiameter d ₀ [mm] | Aandrijving | ETA | Artikelnummer | Aantal per verpakking [st.] | Type verpakking | Aantal per omverpakking [st.] | |
|---------------------|----------------------------|---|--|---------------------------------|-------------|------|---------------|-----------------------------|-----------------|-------------------------------|-----|
| 7,5 ★ | 40 | 6,0 | 1 | 5 | 13,6 | T-30 | ● | 53133 | 50 | VARIANTA | 500 |
| | 45 | 6,0 | 5 | 10 | 13,6 | T-30 | ● | 52808 | 50 | VARIANTA | 500 |
| | 55 | 6,0 | 1/15 | 5/20 | 13,6 | T-30 | ● | 52809 | 50 | VARIANTA | 500 |
| | 65 | 6,0 | 10/25 | 1/15/30 | 13,6 | T-30 | ● | 52810 | 50 | VARIANTA | 500 |
| | 75 | 6,0 | 20/35 | 10/25/40 | 13,6 | T-30 | ● | 52782 | 50 | VARIANTA | 500 |
| | 85 | 6,0 | 10/30/45 | 20/35/50 | 13,6 | T-30 | ● | 52783 | 50 | VARIANTA | 500 |
| | 95 | 6,0 | 20/40/55 | 30/45/60 | 13,6 | T-30 | ● | 52784 | 50 | VARIANTA | 500 |
| | 115 | 6,0 | 40/60/75 | 50/65/80 | 13,6 | T-30 | ● | 56635 | 50 | VARIANTA | 500 |

* Klemdikte t_{fix, standard} en t_{fix, reduced} afhankelijk van de opgegeven draagkracht uit de ETA-15/0784



HECO-accessoires

Overzicht

Assortimentskoffers

- Handige HECO-TOPIX-plus assortimentskoffers in verschillende maten

Bits

- Bijpassende bits en bithouders

HECO-PowerLock

- Houder voor HECO-schroeven met Ø8–13mm

Afdekkapjes

- Kapjes voor alle HECO-schroeven met platzverzonken kop

Onderlegschijsen

- Voor schroeven met platzverzonken kop

Inschroefhulp

- Voor 60°- en 45°-inschroeven de HECO-houtbouwschroeven

Vlonder assortiment

- Bevestigingssystemen en hulpmiddelen voor terrassen

Zetgereedschappen

- Voor houtbouw schroeven
- Voor MULTI-MONTI-TimberConnect

Meethulzen voor MMS-plus

- Ter controle van de schroefdraaddiameter voor meervoudig gebruik

Accessoires ten behoeve van ons schroefassortiment



Selectie van HECO-accessoires



Assortimentskoffers



Bits



Bithouder



Bit-Selector

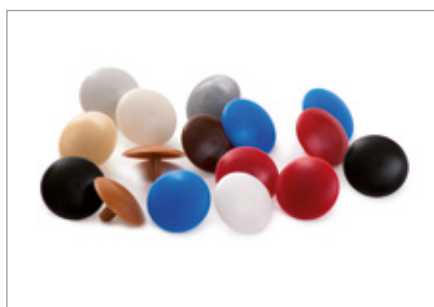

Afdekkapjes



Clipper



Stelvoetjes



Vlonderpads

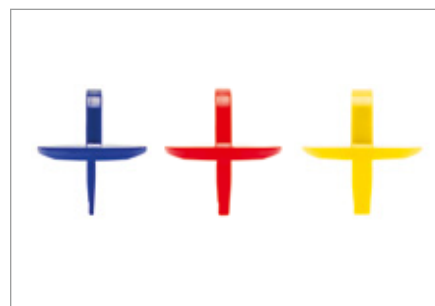

Afstandhouder

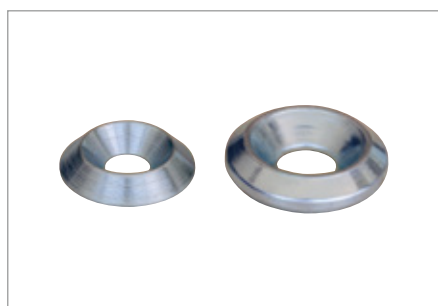

Onderlegschijven



HECO-PowerLock



Inschroefhulp



Zetgereedschappen voor MMS-TimberConnect



Inschroefhulzen voor HECO-WB-draadstangen



Meethulzen voor MULTI-MONTI-plus



HECO-TOPIX-plus assortimentskoffers

Product informatie

- Maximale flexibiliteit bij houtverbindingen dankzij een divers assortiment voldraad en deeldraadschroeven
- Robuuste en duurzame opbergoplossing
- Overzichtelijke organisatie en snelle toegang tot de benodigde schroeven
- Stapelbaar binnen het L-Boxx-systeem
- Verkrijgbaar in groot (L-Boxx 102) en klein assortiment (L-Boxx Mini)
- Alle assortimentskoffers zijn ook leeg verkrijgbaar
- HECO-TOPIX-plus houtschroeven zorgen voor veilige en duurzame verbindingen en bieden unieke voordelen voor gebruikers met de functies MagicClose en GripFit
- Slechts één bitmaat voor alle schroeven
- Alle assortimenten zijn inclusief bijpassende HECO-Drive-bits

Altijd de juiste schroef bij de hand



Inbegrepen schroeftypes

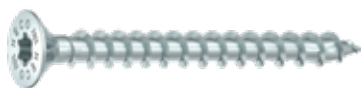

Platverzonden kop, voldraad, HECO-Drive, HD-20, verzinkt blauw, A3K



Platverzonden kop, deeldraad, HECO-Drive, HD-20, verzinkt blauw, A3K

Beschrijving: HECO-assortimentskoffers, L-Boxx-systeem

L-BOXX 102



A



B

L-BOXX Mini



C



D

L-BOXX 238



E

| Uitvoering | Assortiment voldraad | Assortiment deeldraad | Artikelnummer | Aantal [st.] | Type verpakking |
|--|---|---|-----------------------------|--------------|-----------------|
| HECO-TOPIX-plus assortimentskoffer 3005, HECO-L-BOXX 102 met 3.005 schroeven in 20 maten, incl. HECO-Bit-Selector, met inzetbakjes set K3 en dekselinzet | 3,5 x 16mm, 400 st. 3,5 x 20mm, 200 st. 3,5 x 25mm, 200 st. 3,5 x 30mm, 200 st. 3,5 x 35mm, 200 st. 3,5 x 40mm, 200 st. 4,0 x 20mm, 200 st. 4,0 x 25mm, 200 st. 4,0 x 30mm, 200 st. 4,0 x 35mm, 200 st. 4,0 x 40mm, 200 st. 4,0 x 50mm, 100 st. 4,0 x 60mm, 100 st. | 4,5 x 50mm, 100 st. 4,5 x 60mm, 50 st. 4,5 x 70mm, 75 st. 5,0 x 50mm, 50 st. 5,0 x 60mm, 50 st. 5,0 x 70mm, 40 st. 5,0 x 80mm, 40 st. | A 62897 NIEUW | 1 | L-Boxx |
| HECO-assortimentskoffer L-BOXX 102, leeg, met inzetbakjes set K3 en dekselinzet | — | — | B 62899 NIEUW | 1 | L-Boxx |
| HECO-TOPIX-plus assortimentskoffer 700, HECO-L-BOXX Mini met 700 schroeven in 6 maten, incl. 2 HD-20 bits | 3,5 x 16mm, 200 st. 3,5 x 30mm, 200 st. 4,0 x 35mm, 100 st. 4,0 x 40mm, 100 st. | 4,5 x 50mm, 50 st. 4,5 x 60mm, 50 st. | C 62902 NIEUW | 1 | L-Boxx |
| HECO-assortimentskoffer L-BOXX Mini, leeg, incl. instelbare verdelers | — | — | D 62901 NIEUW | 1 | L-Boxx |
| HECO-assortimentskoffer L-BOXX 238, leeg, zonder inzetbakjes en dekselinzet | — | — | E 62900 NIEUW | 1 | L-Boxx |



Bits en bithouder

Product informatie

Algemeen

- Speciaal voor HECO vervaardigde merkbits
- Lange levensduur

HECO-Drive

- Zelf ontwikkeld en gepatenteerd systeem van schroef en bit
- Maakt eenhandig werken mogelijk, ook met roestvrijstalen schroeven dankzij GripFit-effect
- Optimale krachtoverbrenging
- Verminderd corrosiegevaar in schroefkop dankzij lage bitslijtage
- Praktische kleurcodering van de aandrijfgrootten
- Volledige compatibiliteit met T-Drive gegarandeerd (schroeven en bits)

Voor HECO-schroeven met HECO-/T-Drive en Pozi-Drive

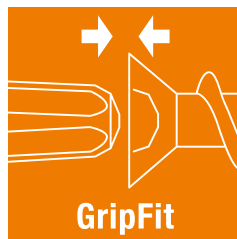

Beschrijving: Schroefbits voor HECO-schroeven met HECO- en Pozi-Drive

| Uitvoering | Aandrijving | Artikelnummer | Aantal [st.] | Type verpakking |
|---|-------------|--------------------|--------------|-----------------|
| HECO-Drive bits, 25 mm | | | | |
|  | HD-10 | 57093 | 10 | Blister |
| | | 59154 NIEUW | 2 | Blister |
| | HD-15 | 57094 | 10 | Blister |
| | | 59155 NIEUW | 2 | Blister |
| | HD-20 | 57095 | 10 | Blister |
| | | 59156 NIEUW | 2 | Blister |
| | HD-25 | 57096 NIEUW | 10 | Blister |
| | | 59889 NIEUW | 2 | Blister |
| | HD-30 | 57097 | 10 | Blister |
| | | 59157 NIEUW | 2 | Blister |
| | HD-40 | 57098 | 10 | Blister |
| | | 59158 NIEUW | 2 | Blister |

| | | | | |
|--|-------|--------------------|---|---------|
| HECO-Drive bits, 70 mm | | | | |
|  | HD-20 | 57101 | 3 | Blister |
| | HD-25 | 59722 NIEUW | 3 | Blister |
| | HD-30 | 57102 | 3 | Blister |
| | HD-40 | 57103 | 3 | Blister |

| | | | | |
|---|-------|-------|----|---------|
| Pozi-Drive bits, 25 mm | | | | |
|  | PZD-1 | 57104 | 10 | Blister |
| | PZD-2 | 57105 | 10 | Blister |
| | PZD-3 | 57106 | 10 | Blister |

Alle HECO-Drive-bits zijn 100% compatibel met conventionele TX-schroeven.

Het GripFit-effect is alleen gegarandeerd bij gebruik met bijpassende HECO-Drive-schroeven.

Beschrijving: HECO-Bit-Selector met HECO-Drive-bits, Pozi-Drive-bits en HECO-ClicFix snelwisselhouder

| Uitvoering | Aandrijving | Artikelnummer | Aantal [st.] | Type verpakking |
|---|-----------------|-------------------------------|-----------------------------|-----------------------------|
| HECO-Bit-Selector | | | | |
|  | zie hieronder | A 57107 B 58561 | 1 | Blister |
| | Inhoud A | | | |
| | 1 x PZD-1 | 1 x HD-10 | 1 x HD-25 | 1x ClicFix snelwisselhouder |
| | 1 x PZD-2 | 1 x HD-15 | 1 x HD-30 | |
| | 1 x PZD-3 | 2 x HD-20 | 1 x HD-40 | |
| | Inhoud B | | | |
| 1 x HD-10 | 3 x HD-20 | 2 x HD-30 | 1x ClicFix snelwisselhouder | |
| 1 x HD-15 | 1 x HD-25 | 2 x HD-40 | | |

Alle HECO-Drive-bits zijn 100% compatibel met conventionele TX-schroeven.

Het GripFit-effect is alleen gegarandeerd bij gebruik met bijpassende HECO-Drive-schroeven.

Beschrijving: Toonbankdisplays met HECO-Drive-bits

Bits, 25mm



Bits, 70mm



| Uitvoering | Inhoud / Bitgroottes | Artikelnummer | Aantal [st.] | Type verpakking |
|--|--|--------------------|--------------|-----------------|
| Toonbankdisplay met HECO-Drive-bits, 25 mm | 70x HD-20 (7 Blister met 10 Bits) 70x HD-25 (7 Blister met 10 Bits) 70x HD-30 (7 Blister met 10 Bits) 70x HD-40 (7 Blister met 10 Bits) | 63100 NIEUW | 1 | POS-display |
| Toonbankdisplay met HECO-Drive-bits, 70 mm | 21x HD-20 (7 Blister met 3 Bits) 21x HD-25 (7 Blister met 3 Bits) 21x HD-30 (7 Blister met 3 Bits) 21x HD-40 (7 Blister met 3 Bits) | 63101 NIEUW | 1 | POS-display |

158

Beschrijving: Blister-Trays met HECO-Drive-Bits

Bits, HD-20



Bits, HD-25



Bits, HD-30



Bits, HD-40



| Uitvoering | Inhoud / Bitgroottes | Artikelnummer | Aantal [st.] | Type verpakking |
|--|-----------------------------------|--------------------|--------------|-----------------|
| Blister-Tray met HECO-Drive-bits, HD-20, 25 mm | 30x HD-20 (15 Blister met 2 Bits) | 62498 NIEUW | 1 | POS-display |
| Blister-Tray mit HECO-Drive-bits, HD-25, 25 mm | 30x HD-25 (15 Blister met 2 Bits) | 63099 NIEUW | 1 | POS-display |
| Blister-Tray mit HECO-Drive-bits, HD-30, 25 mm | 30x HD-30 (15 Blister met 2 Bits) | 62500 NIEUW | 1 | POS-display |
| Blister-Tray mit HECO-Drive-bits, HD-40, 25 mm | 30x HD-40 (15 Blister met 2 Bits) | 62501 NIEUW | 1 | POS-display |

Beschrijving: HECO-ClicFix snelwisselhouder



| Uitvoering | Artikelnummer | Aantal [st.] | Type verpakking |
|---|---------------|--------------|-----------------|
| HECO-ClicFix snelwisselhouder, magnetisch, vorm E 6,3, geanodiseerd aluminium | 48541 | 1 | Bliester |

Beschrijving: HECO-MagicFlip magnetische bithouder



| Uitvoering | Artikelnummer | Aantal [st.] | Type verpakking |
|---|---------------|--------------|-----------------|
| HECO-MagicFlip magnetische bithouder, houdt houtbouwschroeven betrouwbaar vast op het bit | 57715 | 1 | Bliester |

159

Beschrijving: HECO-Stubby Mini-schroevendraaier met 6-delige bitmagazijn in handvat



| Uitvoering | Artikelnummer | Aantal [st.] | Type verpakking |
|---|------------------|--------------|-----------------|
| HECO-Stubby Mini-schroevendraaier met 6-delige bitmagazijn in handvat Bits: HD-10, HD-15, HD-20, HD-30, PZD-1, PZD-2 | 63073 NEU | 1 | SKV |



Montagegereedschappen voor HECO-WR

Product informatie HECO-PowerLock

- Voorkomt dat het bit wegglijdt van de schroefkop
- Maakt krachtbesparend indraaien mogelijk
- Maakt een snelle en betrouwbare montage mogelijk
- Geschikt voor HECO-WR-T Ø13mm en HECO-TOPIX-platverzonken schroeven Ø10mm
- Max. draaimoment 130Nm
- Inclusief T-40 en T-50 bits



▶ Video



Productaanbeveling voor optimale verwerking:

Schroefboormachine AMB 1200 HTC of een soortgelijk product

Aangegeven vermogen:

1200 W, 65-110 Nm, 70-530 omw./min



Vervangend bit T-40, 50mm



Vervangend bit T-50, 50mm

Beschrijving: HECO-PowerLock houtboorschroefhouder incl. bits

| Uitvoering | Artikelnummer | Aantal [st.] | Type verpakking |
|--|---------------|--------------|-----------------|
| HECO-PowerLock, incl. 1x T-40 en 1x T-50 Bit | 57263 | 1 | Bliester |
| Vervangend bit voor HECO-PowerLock, T-40 | 57762 | 1 | Bliester |
| Vervangend bit voor HECO-PowerLock, T-50 | 57763 | 1 | Bliester |



Beschrijving: Schroevendraaierbits, aandrijving 1/2"

| Uitvoering | Artikelnummer | Aantal [st.] | Type verpakking |
|------------|--------------------|--------------|-----------------|
| Bit T30-40 | 59307 NIEUW | 1 | SFS-box |
| Bit T40-40 | 59308 NIEUW | 1 | SFS-box |
| Bit T50-40 | 59309 NIEUW | 1 | SFS-box |



Beschrijving: Adapterstuk, morseconus 1/2"

| Uitvoering | Artikelnummer | Aantal [st.] | Type verpakking |
|------------|--------------------|--------------|-----------------|
| MK 3 | 59306 NIEUW | 1 | SFS-box |



Montagegereedschappen voor HECO-WS

Product informatie

- Afgestemd systeem
- Betrouwbaar en robuust voor gebruik bij veeleisende projecten
- Voor comfortabele en efficiënte montage
- Eenvoudig en ongecompliceerd gebruik
- Advies en instructies middels toepassingstechniek
- Ook als voordelig huurapparaat voor de duur van het project
- Vervangende bits ook apart verkrijgbaar

Voor een efficiënte montage van de HECO-WS staalen deuvels



Magetische bithouder



Vervangend bit voor
CF-WS-M



Vervangend bit voor
CF-WS-P

161

Beschrijving: Onderdelen voor HECO-WS montagegereedschappen

| Uitvoering | Artikelnummer | Aantal [st.] | Type verpakking |
|--------------------------------------|--------------------|--------------|-----------------|
| Magetische bithouder ZA 1/4"-CF-WS/M | 59296 NIEUW | 1 | Plastic zak |
| Bit voor CF-WS-M, T40-70-D7-Hex-1/4" | 59297 NIEUW | 1 | Plastic zak |
| Bit voor CF-WS/P, T40-40-M8 | 59298 NIEUW | 1 | Plastic zak |



Montagegereedschap pneumatisch
CF WS/P
Art.-Nr. 59287 **NIEUW**



Montagegereedschap handmatig
CF WS/M
Art.-Nr. 59288 **NIEUW**

De bijbehorende HECO-WS staalen deuvels vindt u op pagina 123

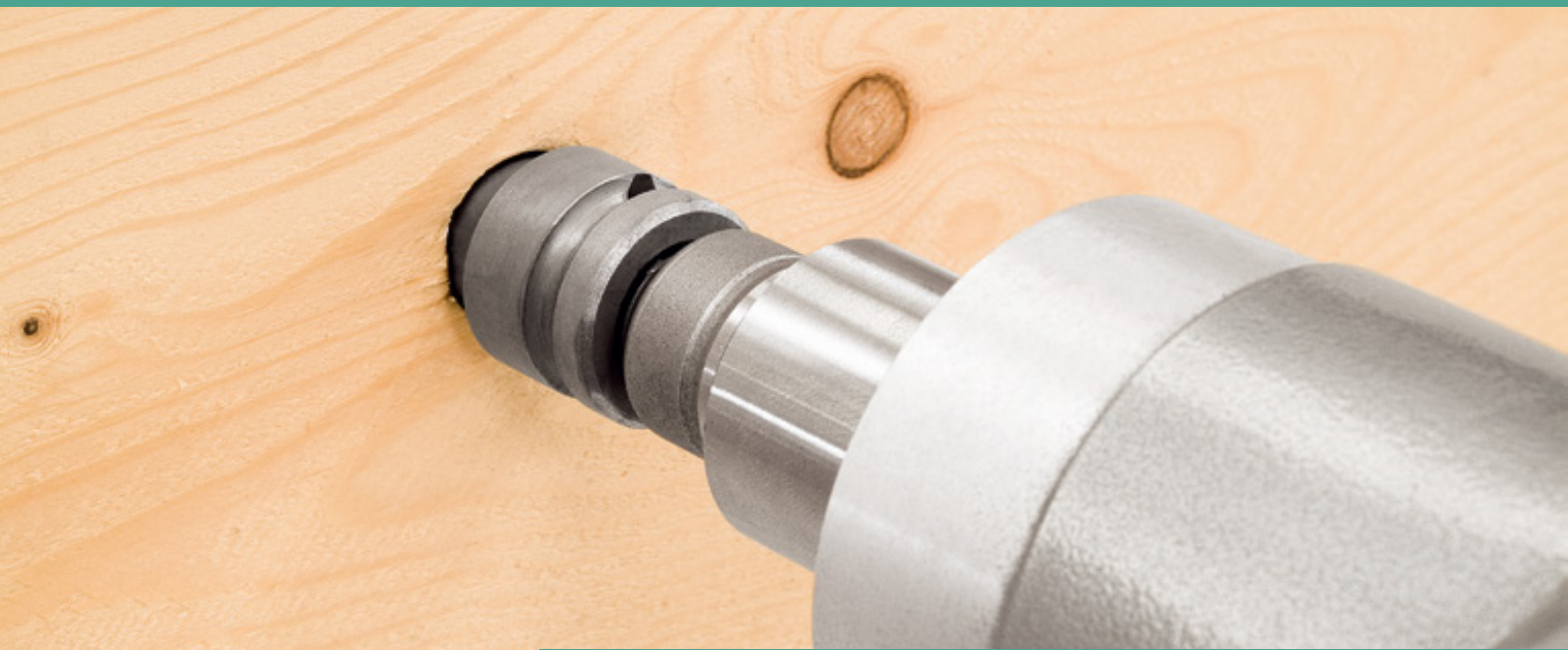

HECO-WB inschroefhulzen

Product informatie

HECO-WB inschroefhuls Ø 16

- Robuuste afwerking
- Verzinkbaar

HECO-WB inschroefhuls Ø 20

- Met zetmarkering voor nauwkeurig verzinken
- Met conische voorzijde voor eenvoudig verzinken

Inschroefhulzen voor verzinken van de HECO-WB draadstangen met 1/2"-steeksleutelaandrijving



Stompe variant



Beschrijving: HECO-WB Inschroefhulzen

| Uitvoering | Artikelnummer | Aantal [st.] | Type verpakking |
|-----------------------------------|--------------------|--------------|-----------------|
| HECO-WB inschroefhuls Ø 16 | 53355 | 1 | Plastic zak |
| HECO-WB inschroefhuls Ø 16, stomp | 59282 NIEUW | 1 | Plastic zak |
| HECO-WB inschroefhuls Ø 20, stomp | 53356 | 1 | Plastic zak |

De bijbehorende HECO-WB draadstangen vindt u op pagina 125



Schroefmachines en boorsystemen HECO-WB

Product informatie

- Hout-spiraalboor
- Optimale voorboordiameter
- volg. voorschrift van de ETA
- In een set met verlenging tot een totale lengte van max. 2,4 m
- Vervangende boor apart verkrijgbaar



Boorsysteem met verlenging (in de set)



Vervangende boor (apart)

163

Beschrijving: Boorsysteem voor HECO-WB

| Uitvoering | Diameter | Artikelnummer | Aantal [st.] | Type verpakking |
|-----------------------------|----------|--------------------|--------------|-----------------|
| Boorsysteem voor HECO-WB-16 | 12 | 59283 NIEUW | 1 | SFS-box |
| Vervangende boor HECO-WB-16 | 12 | 59285 NIEUW | 1 | SFS-box |
| Boorsysteem voor HECO-WB-20 | 15 | 59284 NIEUW | 1 | SFS-box |
| Vervangende boor HECO-WB-20 | 15 | 59286 NIEUW | 1 | SFS-box |



Productaanbeveling voor optimale verwerking:

Schroefboormachine EHB 32/2.2 R R/L of een soortgelijk product

Aangegeven vermogen:

800 W, 22-80 Nm, 60-470 omw./min



Diepgatboorsysteem DWA-systeem persluchtondersteund, complete set Art.-Nr. 59292 **NIEUW**

De bijbehorende HECO-WB draadstangen vindt u op pagina 125



Montagegereedschappen voor HECO-VB

Product informatie

- Afgestemd systeem
- Betrouwbaar en robuust voor gebruik bij veeleisende projecten
- Voor comfortabele en efficiënte montage
- Eenvoudig en ongecompliceerd gebruik
- Advies en instructies middels toepassingstechniek
- Ook als voordelig huurapparaat voor de duur van het project
- Vervangende bits ook apart verkrijgbaar

Voor een efficiënte montage van de HECO-VB hout-beton-verbindingsschroeven



Vervangend bit



Verlenging

Beschrijving: Onderdelen voor HECO-VB montagegereedschappen

| Uitvoering | Artikelnummer | Aantal [st.] | Type verpakking |
|---------------------------------------|--------------------|--------------|-----------------|
| Vervangend bit V40-15-E8 voor CF-VB/L | 59299 NIEUW | 1 | Plastic zak |
| Verlenging 1/4" -E6,3 voor CF-VB/L | 59300 NIEUW | 1 | Plastic zak |



Montagegereedschap handmatig
CF VB/L
Art.-Nr. 59289 **NIEUW**



De bijbehorende HECO-VB hout-beton-verbindingsschroeven vindt u op pagina 127



Zetgereedschap voor MMS-TC

Product informatie

- Het voor MMS-TC voorgeschreven zetgereedschap
- Speciaal voor HECO vervaardigde zetgereedschap
- Goedgekeurd Z-21.1-1879
- Inschroefdieptemarkering met schaalverdeling voor MMS-TC
- Afgestemd systeem van schroef en bit:
 - betere pasnauwkeurigheid
 - optimale krachtoverbrenging
 - minder doldraaien
- Lange levensduur



Voor de juiste montage van MULTI-MONTI-TimberConnect



165

De juiste montage

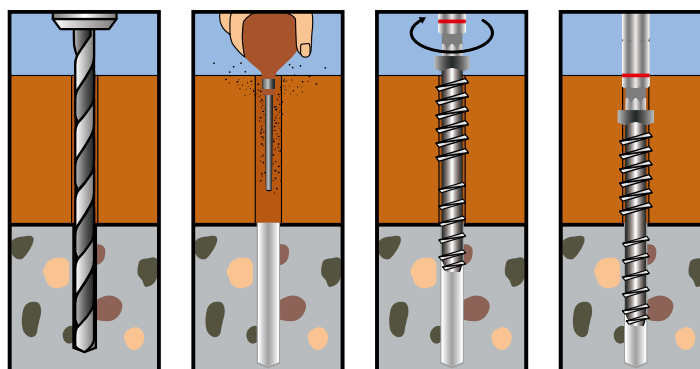

▶ Video

Beschrijving: Zetgereedschap voor MULTI-MONTI-TimberConnect

| Uitvoering | Aandrijving | Art.Nr. | Aantal [st.] | Type verpakking |
|-------------------------|-------------------|-----------------------|--------------|-----------------|
| Voor MMS-TC Ø 7,5, T-30 | bitaandrijving | 43603 | 1 | Blister |
| Voor MMS-TC Ø 10, T-45 | 1/2"-steeksleutel | 47095 | 1 | Blister |
| Voor MMS-TC Ø 12, T-50 | 1/2"-steeksleutel | 43605 | 1 | Blister |

Bijbehorend schroefanker MMS-TC vindt u op pagina 145



Meethulzen voor MULTI-MONTI-plus

Product informatie

- Metalen meethuls ter controle van de schroefdraaddiameter voor meervoudig gebruik van MMS-plus 10 tot MMS-plus 20 bij tijdelijke bevestigingen
- Materiaal: roestvaststaal

Slijtagecontrole door middel van een meethuls voor meervoudig gebruik van MMS-plus schroefankers

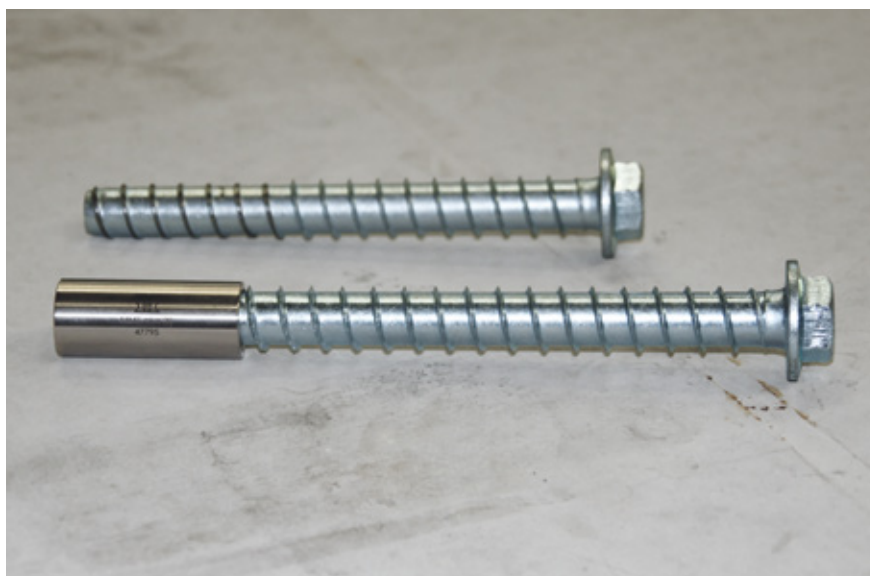

Beschrijving: Meethulzen voor meervoudig gebruik van de MULTI-MONTI-plus

| Uitvoering | Hulsdiameter [mm] | Hulslengte [mm] | Artikelnummer | Aantal [st.] | Type verpakking |
|--------------------------------|-------------------|-----------------|-----------------------|--------------|-----------------|
| HECO-meethuls voor MMS-plus 10 | 9,5 | 24 | 47792 | 1 | Plastic zak |
| HECO-meethuls voor MMS-plus 12 | 11,5 | 32 | 47793 | 1 | Plastic zak |
| HECO-meethuls voor MMS-plus 16 | 15,5 | 36 | 47794 | 1 | Plastic zak |
| HECO-meethuls voor MMS-plus 20 | 19,5 | 58 | 47795 | 1 | Plastic zak |

Bijbehorend schroefanker MMS-plus vindt u op pagina's 134 tot 147



HECO-vlondergeleidersets

Product informatie

Vlondergeleiders voor gegroefde vlonderplankene

- Afstand van de vlonderplank automatisch ingesteld
- Constructieve bescherming van het hout – geen hout op hout, zorgt voor ventilatie tussen de deklagen
- Eenvoudige montage met de HECO-TOPIX-vlondergeleiderschroef
- Per verbinding maar 1 schroef (minder bevestigingspunten)

Vlondergeleiderschroef

- HECO-TOPIX-vlondergeleiderschroef met cilinderkop
- 4,5 x 50mm, roestvaststaal A2
- HD-bit met GripFit-effect (inbegrepen in de grote set) voor het eenhandig indraaien van de schroef
- De op het systeem aangepaste cilinderkop past precies tussen de vlonderplanken

Weerbestendige kunststof box

- Keuze uit twee verpakkingen met 30 stuks en met 80 stuks
- Inclusief gebruiksaanwijzing

Het complete pakket voor snelle en nette montage van vlonders



Beschrijving: HECO-vlondergeleider assortiment

| Uitvoering | Artikelnummer | Aantal [st.] | Type verpakking |
|--|-----------------------|--------------|-----------------|
| Kleine vlondergeleiderset middengeleider | 48715 | 1 | Kunststof box |
| Grote vlondergeleiderset middengeleider | 48716 | 1 | Kunststof box |
| Kleine vlondergeleiderset randgeleider | 48717 | 1 | Kunststof box |

HECO-vlondergeleidersets – inhoudsoverzicht

Kleine vlondergeleiderset middengeleider

| | |
|-----------------------------------|--------|
| Vlondergeleider middengeleider | 30 st. |
| HECO-TOPIX-vlondergeleiderschroef | 30 st. |

**Grote vlondergeleiderset middengeleider**

| | |
|---|--------|
| Vlondergeleider middengeleider | 80 st. |
| HECO-TOPIX-vlondergeleiderschroef | 80 st. |
| Bit HECO-Drive (aandrijfgrootte: HD-20) | 1 st. |

**Kleine vlondergeleiderset randgeleider**

| | |
|-----------------------------------|--------|
| Vlondergeleider randgeleider | 30 st. |
| HECO-TOPIX-vlondergeleiderschroef | 30 st. |



Met een kleine vlondergeleiderset kan ca. 2 m² en met een grote vlondergeleiderset kan ca. 7 m² vlonderooppervlak gemonteerd worden

Kleine vlondergeleiderset – verkoop per omdoos van 4 VE

Grote vlondergeleiderset – verkoop per omdoos van 2 VE

Bestelhoeveelheid per omdoos

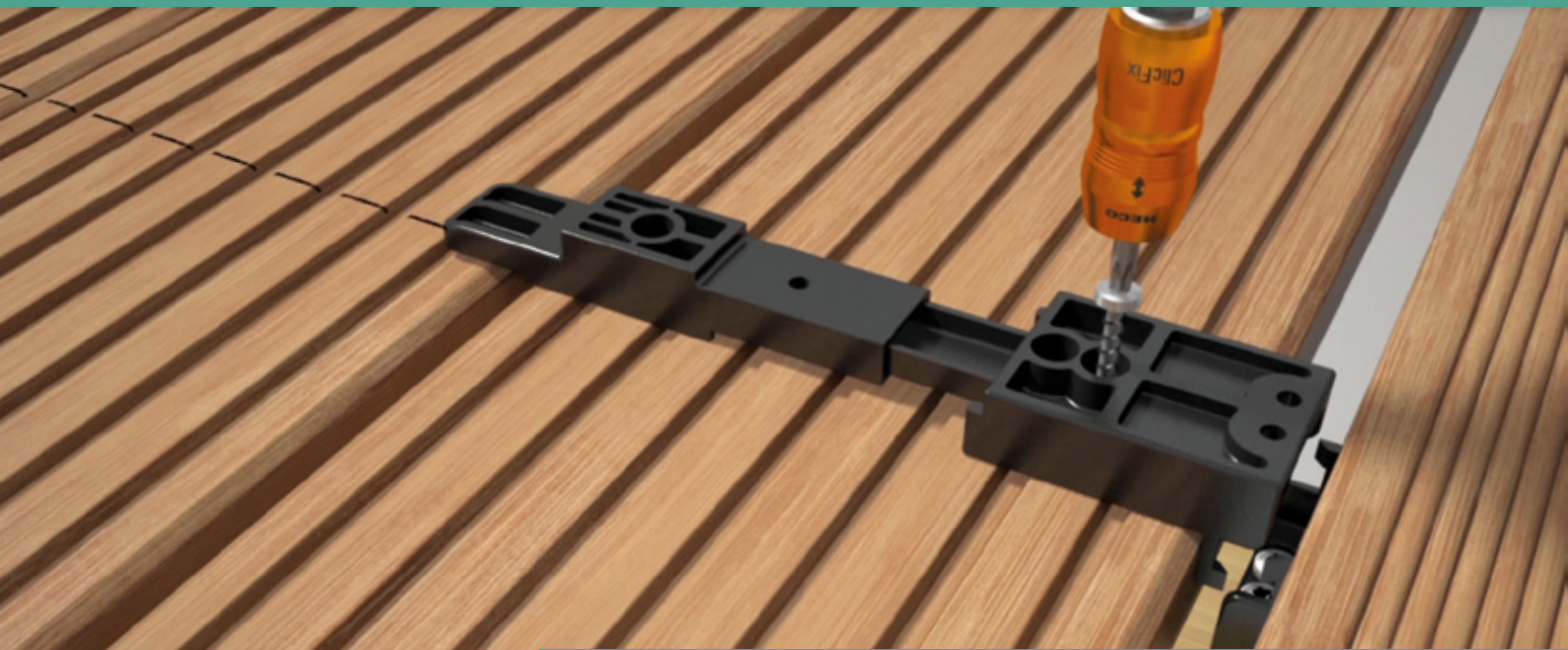

HECO-clipperset

Product informatie

HECO-clipper

- Onzichtbare bevestiging incl. HECO-TOPIX-plus schroeven van rvs, geen schroeven in de bovenkant van de bedekking
- Constructieve houtbescherming – geen hout op hout, zorgt voor achterventilatie van de deklagen
- Afstandhouders tussen de planken (5 mm), snelle montage en een gelijkmatig voegenbeeld
- Plankbreedten variabel tussen 120–150 mm
- De arreteerpin zorgt voor een eenvoudige montage
- De planken kunnen in alle richtingen opzetten en krimpen
- De planken kunnen snel en zonder beschadigingen worden gedemonteerd – ideaal voor huurhuizen (bij een verhuizing)
- Van glasvezelversterkte polyamide (min. 98 % gerecycled materiaal)

HECO-TOPIX-plus clipperschroeven

- HECO-TOPIX-plus-clipperschroeven met ronde kop en T-Drive voor een exacte schroefverbinding
- 4,0 x 25 en 4,0 x 30 mm, roestvaststaal A2

De onzichtbare bevestiging voor vlonderbekledingen van hout en WPC zonder groef



Video

Beschrijving: HECO-clipper met HECO-TOPIX-plus-clipperschroeven

| Uitvoering | Artikelnummer | Aantal [st.] | Type verpakking |
|------------|---------------|--------------|-----------------|
|------------|---------------|--------------|-----------------|

| | | | |
|-----------------|-------|---|--------|
| HECO-clipperset | 62052 | 1 | Karton |
|-----------------|-------|---|--------|

Inhoud

| | |
|--|---------|
| HECO-clipper 120–150 mm | 50 st. |
| HECO-TOPIX-plus-clipperschroeven 4,0 x 25 mm (vlonderdikte 20 – 24 mm) | 150 st. |
| HECO-TOPIX-plus-clipperschroeven 4,0 x 30 mm (vlonderdikte 20 – 24 mm) | 100 st. |



HECO-vlonderpads

Product informatie

- Vochtregulerend
- Geluid isolerend
- Geen waterberging
- Onverrotbaar
- Anti-slip
- De pads zijn in drie diktes verkrijgbaar: 3, 8 en 20 mm (de 3 mm dikke pad is uitsluitend als vereffeningspad bedoeld)
- De aanbevolen minimale dikte van de pads onder de houten constructie bedraagt 8 mm

De veilige onderbouw voor elke vlonder

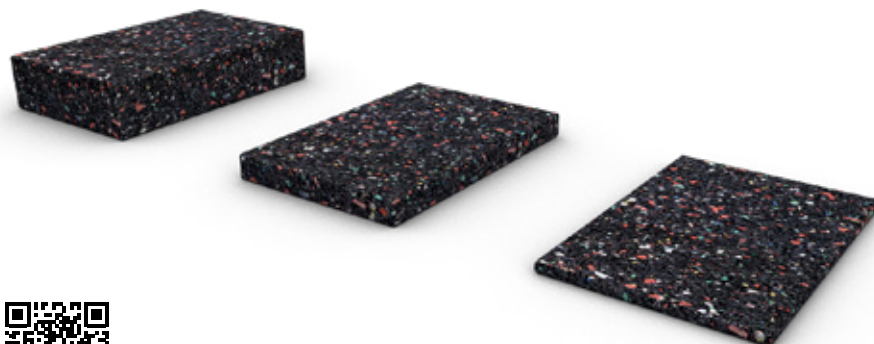

▶ Video

Beschrijving: HECO-vlonderpads (vereffeningspads)

| Uitvoering | Artikelnummer | Aantal [st.] | Type verpakking |
|---------------------------------------|-----------------------|--------------|-----------------|
| HECO-vlonderpads 3 x 60 x 90, 60 st. | 49770 | 1 | Karton |
| HECO-vlonderpads 8 x 60 x 90, 24 st. | 49771 | 1 | Karton |
| HECO-vlonderpads 20 x 60 x 90, 12 st. | 49772 | 1 | Karton |



HECO-stelvoetjes

Product informatie

- De stelvoet is binnen zijn marges traploos instelbaar
- Door de voetjes gewoon naar rechts of links te draaien, kan de vereiste hoogte ook in ingebouwde staat eenvoudig worden ingesteld
- De beweeglijke kop compenseert hellingen van de ondergrond tot max. 8%
- Zeer goede achterventilatie van de vlonderconstructie
- Stelvoet vervaardigt uit hard kunststof polypropyleen



 Video

Perfect voor oneffen terrein



Beschrijving: HECO-stelvoetjes, hoogte verstelbaar, zelfnivellerend

| Uitvoering | Artikelnummer | Aantal [st.] | Type verpakking |
|---|-----------------------|--------------|-----------------|
| HECO-stelvoetjes, hoogte: 35 – 70 mm, 42 st. | 58010 | 1 | Karton |
| HECO-stelvoetjes, hoogte: 65 – 155 mm, 32 st. | 58011 | 1 | Karton |

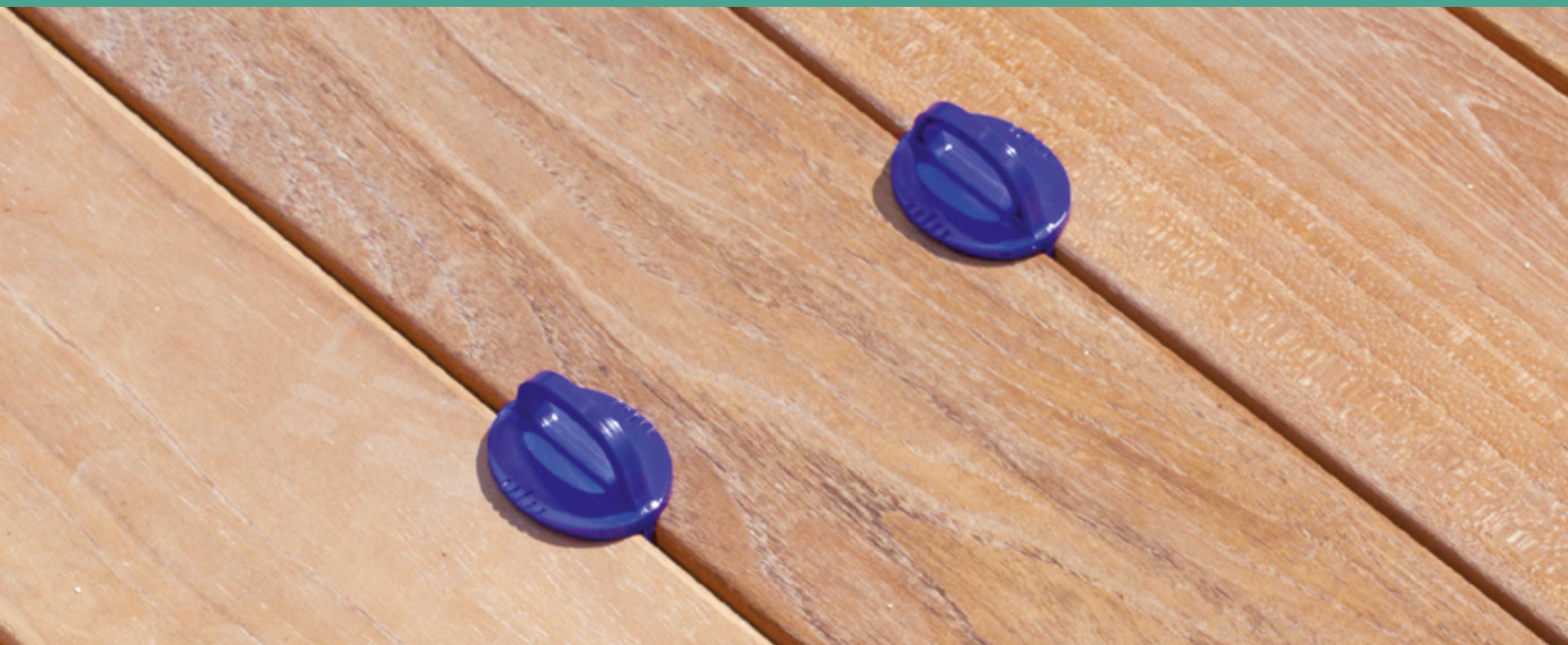

HECO-afstandhouder

Product informatie

- De kleurcodering van de afstandhouders voorkomt een verwisseling bij het aanleggen van de vlonder
- Door de vorm van de afstandhouders wordt voorkomen dat deze tussen de planken in de voegenspleet kunnen vallen
- Dankzij de greep kan de afstandhouder ook als hij stevig zit vastgeklemd makkelijk worden verwijderd
- De randen van de afstandhouder zijn op belangrijke plaatsen behandeld/afgeschuind; deuken in het hout worden op deze manier voorkomen

Gelijkmatig voegenbeeld ook bij vloerplanken die niet recht zijn



173



Beschrijving: HECO-afstandhouder

| Uitvoering | Artikelnummer | Aantal [st.] | Type verpakking |
|-----------------------------|---------------|--------------|-----------------|
| HECO-afstandhouder | 49774 | 1 | Kunststof box |
| Inhoud | | | |
| 3 mm – blauwe afstandhouder | 8 st. | | |
| 5 mm – rode afstandhouder | 8 st. | | |
| 7 mm – gele afstandhouder | 8 st. | | |

Verkoop per omdoos van 4 VE – Bestelhoeveelheid per omdoos



HECO-spanner voor vlonderplanken

Product informatie

- Vlonderplanken spanner met drie afstandhouders, daardoor kunnen meerdere breedtes gelijktijdig gespannen worden
- Er zijn haast traploze spanbreedten mogelijk
- Zelfs een grote spankracht kan met een geringe spierkracht worden gerealiseerd
- De montage van de gespannen vlonderplanken kan plaatsvinden zonder zekering of permanent vasthouden van de spanner

Krachtig, robuust en flexibel



Beschrijving: HECO-spanner voor vlonderplanken

| Uitvoering | Artikelnummer | Aantal [st.] | Type verpakking |
|----------------------------------|-----------------------|--------------|-----------------|
| HECO-spanner voor vlonderplanken | 49767 | 1 | Karton |



HECO-vlonderboor

Product informatie

- Hoogwaardige schroefboren voor vlonderdelen
- Combinatie van boor en soevereinfrees
- Snel en schoon werken zonder splinters
- Vlonderdelen splijten niet
- Vervangende boor als toebehør verkrijgbaar

Vlonderdelen snel en netjes monteren



175

Beschrijving: HECO-schroefboren voor vlonderdelen en trapboren

| Uitvoering | Artikelnummer | Aantal [st.] | Type verpakking |
|-----------------------|---------------|--------------|-----------------|
| HECO-vlonderboor | 47375 | 1 | Bliester |
| HECO-vervangende boor | 47875 | 1 | Bliester |

De bijbehorende vlonderschroeven vindt u op pagina's 97 en 99



Onderlegschijven

Product informatie

- Onderlegschijven voor HECO-TOPIX-plus schroeven met platverzonken kop, diameter 8 en 10mm

Voor HECO-TOPIX-plus schroeven met platverzonken kop



Beschrijving: Onderlegschijven, verzinkt blauw, A2K

| Uitvoering | Schroef-Ø [mm] | Artikelnummer | Aantal [st.] | Type verpakking |
|---------------------------|----------------|-----------------------|--------------|-----------------|
| Onderlegschijven, Ø 25 mm | 8 | 42260 | 50 | SKV |
| Onderlegschijven, Ø 30 mm | 10 | 42281 | 50 | SKV |



Inschroefhulp

Product informatie

- 60° en 45° tov oppervlakte
- 45°-inschroeven ook dicht aan de rand mogelijk
- Met schaalverdeling
- Gereedschap glijdt niet weg door speciale vorm

Inschroefhulp voor HECO-TOPIX-plus houtbouschroeven



177

Beschrijving: HECO-inschroefhulp, kunststof, oranje

| Uitvoering | Artikelnummer | Aantal [st.] | Type verpakking |
|--------------------|---------------|--------------|-----------------|
| HECO-inschroefhulp | 45734 | 1 | Karton |

De bijpassende HECO-TOPIX-plus houtbouschroeven, HECO-TOPIX-plus Therm en HECO-TOPIX-plus CombiConnect vindt u op pagina's 107 en 110



Afdekkapjes



Product informatie

- Plastic afdekkapjes voor schroeven
- Verschillende gangbare RAL-kleuren
- Andere kleuren op aanvraag

Voor HECO-schroeven met platverzonken kop



Beschrijving: Afdekkapjes voor HECO-schroeven platkop met koptgatboring, PZD, T-Drive en HECO-Drive

| Uitvoering | Andrijving | Diameter [mm] | RAL | Kleuren | Artikelnummer | Aantal [st.] | Type verpakking |
|---|------------|---------------|------|------------|-----------------------|--------------|-----------------|
| Afdekkapjes voor koptgat | | | | | | | |
|  | 2,4 mm | 12 | 1001 | beige | 19846 | 500 | Plastic zak |
| | 2,4 mm | 12 | 8001 | okerbruin | 19865 | 500 | Plastic zak |
| | 2,4 mm | 12 | 8007 | reebruin | 19866 | 500 | Plastic zak |
| | 2,4 mm | 12 | 8011 | notenbruin | 19868 | 500 | Plastic zak |
| | 2,4 mm | 12 | 8012 | roodbruin | 19869 | 500 | Plastic zak |
| | 2,4 mm | 12 | 9005 | zwart | 19872 | 500 | Plastic zak |
| | 2,4 mm | 12 | 9010 | wit | 19874 | 500 | Plastic zak |
| Afdekkapjes voor Pozi-Drive | | | | | | | |
|  | PZD-2 | 12 | 1001 | beige | 19885 | 500 | Plastic zak |
| | PZD-2 | 12 | 8001 | okerbruin | 19914 | 500 | Plastic zak |
| | PZD-2 | 12 | 8007 | reebruin | 20140 | 500 | Plastic zak |
| | PZD-2 | 12 | 8011 | notenbruin | 19897 | 500 | Plastic zak |
| | PZD-2 | 12 | 8012 | roodbruin | 19898 | 500 | Plastic zak |
| | PZD-2 | 12 | 9005 | zwart | 19899 | 500 | Plastic zak |
| | PZD-2 | 12 | 9010 | wit | 19900 | 500 | Plastic zak |
| | PZD-3 | 12 | 1001 | beige | 19902 | 500 | Plastic zak |
| | PZD-3 | 12 | 8001 | okerbruin | 19907 | 500 | Plastic zak |
| | PZD-3 | 12 | 8007 | reebruin | 19908 | 500 | Plastic zak |
| | PZD-3 | 12 | 8011 | notenbruin | 19909 | 500 | Plastic zak |
| | PZD-3 | 12 | 8012 | roodbruin | 19910 | 500 | Plastic zak |
| | PZD-3 | 12 | 9005 | zwart | 19911 | 500 | Plastic zak |
| | PZD-3 | 12 | 9010 | wit | 19913 | 500 | Plastic zak |
| Afdekkapjes voor T- en HECO-Drive | | | | | | | |
|  | T-/HD-15 | 12 | 8011 | notenbruin | 19925 | 500 | Plastic zak |
| | T-/HD-15 | 12 | 9005 | zwart | 19921 | 500 | Plastic zak |
| | T-/HD-15 | 12 | 9010 | wit | 19923 | 500 | Plastic zak |
| | T-/HD-20 | 12 | 8011 | notenbruin | 48711 | 500 | Plastic zak |
| | T-/HD-20 | 12 | 9005 | zwart | 48713 | 500 | Plastic zak |
| | T-/HD-20 | 12 | 9010 | wit | 39844 | 500 | Plastic zak |
| | T-/HD-25 | 15 | 8011 | notenbruin | 19922 | 500 | Plastic zak |
| | T-/HD-25 | 15 | 9005 | zwart | 19926 | 500 | Plastic zak |
| | T-/HD-25 | 15 | 9010 | wit | 19939 | 500 | Plastic zak |

* Schroeven met passende koptgatboring op pagina 55

Speciale kleuren: levering vanaf 50.000 stuks mogelijk, RAL-nummer aangeven, prijs op aanvraag

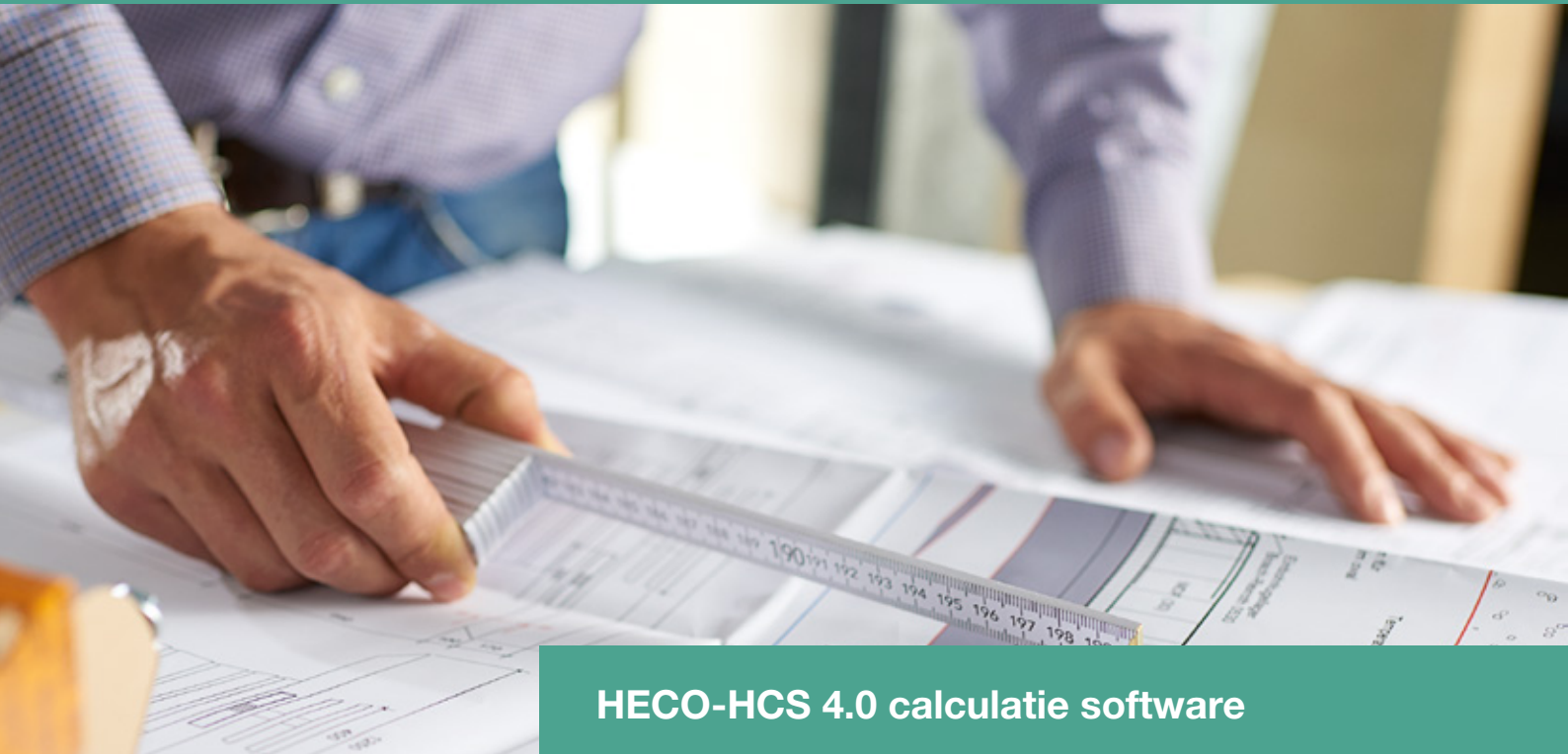

HECO-HCS 4.0 calculatie software

Product informatie

- Professionele rekenhulp
- Calculatie van HECO-producten
- Calculatie tools:
 - Plugdimensionering
 - Leuningbevestiging
 - Isolatiemateriaal op dakspanten
 - Bewijs opwaartse kracht
 - Dimensionering houtbouw
 - Geveldimensionering
- In totaal 17 verschillende calculatie tools
- Eenvoudige invoer
- Uitgewerkte berekening met schets
- Kosteloos als download of als CD verkrijgbaar

Professionele calculatie tools van HECO





Calculatie tools

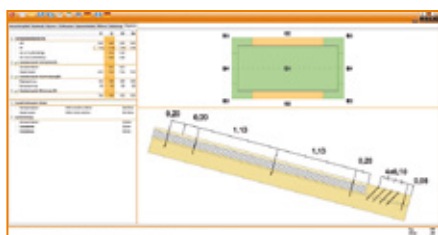

Isolatiemateriaal op dakspanten

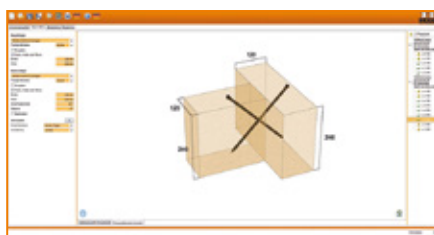

Dwarsbalk verbinding



Leuningbevestiging

181



Beschrijving: HECO-HCS 4.0 calculatie software, als download via www.heco-schrauben.nl of als CD verkrijgbaar

| Uitvoering | Artikelnummer | Aantal [st.] | Type verpakking |
|----------------------------------|---------------|--------------|-----------------|
| HECO-HCS 4.0 calculatie software | 42531 | 1 | Slimcase |

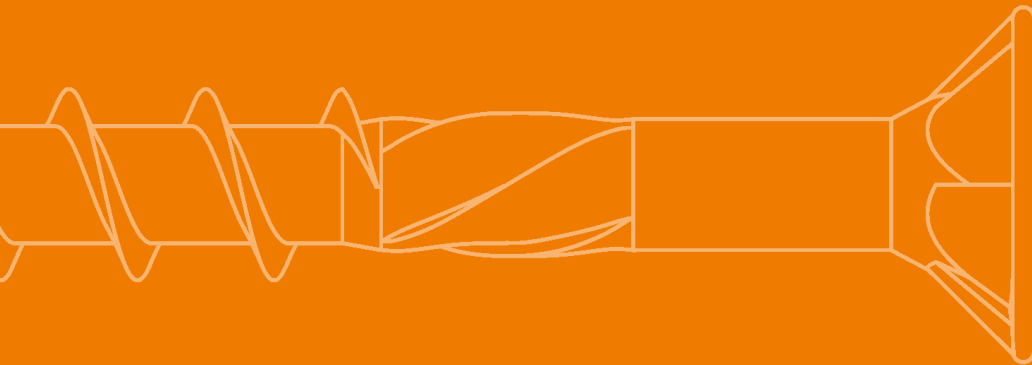
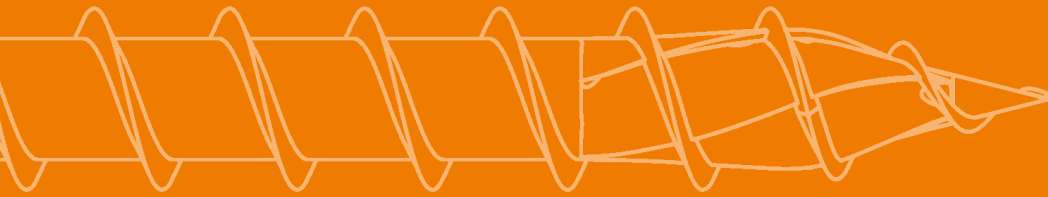

www.heco-schrauben.com

HECO-Schrauben GmbH & Co. KG
Dr.-Kurt-Steim-Straße 28, 78713 Schramberg
Telefon +49 (0)7422/989-0, Fax +49 (0)7422/989-200

A partner of **SFS**

Agent Benelux: Jac. Lowie & Zoon bv
Korte Brinkweg 37b, 3761 EC SOEST
Telefoon: +31 (0)3 5 / 54 159 58, E-mail: office@lowie.nl

