

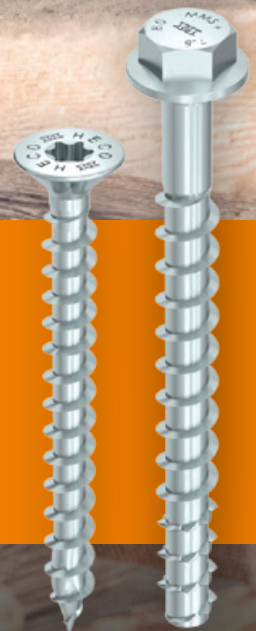

HECO-Schrauben

Productcatalogus 2026





Wij willen enthousiasme creëren met verbindingen.

Onze visie als schroevenfabrikant en -leverancier is, om u te inspireren met verbindingen. In de loop der jaren heeft HECO de bevestigingswereld verrijkt met echte innovaties. Of het nu gaat om de ontwikkeling van het MULTI-MONTI schroefanker, dat een revolutie teweeg heeft gebracht op het gebied van bevestigingen in beton, of met de HECO-TOPIX-plus met zijn werkelijk unieke eigenschappen, het is ons altijd gelukt om u producten te bieden met echte voordelen voor uw dagelijkse werk. Voordelen die uw werk eenvoudiger en uw verbindingen veiliger maken. Met de presentatie van deze productcatalogus tonen we opnieuw op indrukwekkende wijze deze innovatiekracht.

We hebben de HECO productcatalogus een nieuwe structuur gegeven. De catalogus is niet langer gesorteerd op productfamilie, maar op toepassingsgebied. De nieuwe hoofdstukken, die ook worden aangegeven door de kleurenbalk bovenaan de pagina, zijn als volgt:

- Universele houtschroeven
- Houtbouwschroeven
- Schroeven voor beton en metselwerk
- Terrasbouw
- Schroeven assortimenten
- Bits en bithouders

De bijpassende accessoires zijn nu direct toegewezen aan het corresponderende productgebied, met uitzondering van bits en bithouders, die nu in een apart hoofdstuk zijn opgenomen. Hierdoor vindt u sneller en eenvoudiger de schroeven die u nodig heeft in de juiste toepassingscontext. Nieuwe producten zijn gemarkeerd met “Nieuw” en zijn daardoor goed herkenbaar binnen het assortiment.

Een andere nieuwe functie is een overzicht van ons uitgebreide dienstenaanbod (zie p. 6). Van calculatiesoftware tot digitale

diensten en trainingen, wij ondersteunen u in uw dagelijkse werk. Maak gebruik van ons en onze diensten en profiteer van de vereenvoudiging van uw werk.

We hebben de innovatieve functies van de HECO-TOPIX-plus - “GripFit”, “MagicClose” en “PerfectPitch” - belicht met pictogrammen, zodat u de deze productkenmerken meteen herkent. U kunt ook de veelzijdige toepassingsmogelijkheden en goedkeuringen van onze beproefde MULTI-MONTI-plus schroefankers zien, aan de hand van overeenkomstige symbolen. De aandrijfmaten worden geïdentificeerd door een kleurcoderingssysteem die ook te vinden is op de verpakking van de schroeven en op de bijpassende HECO-bits.

Een andere praktische toevoeging zijn de QR-codes, die op diverse cataloguspagina's te vinden zijn. Scan ze met uw smartphone of tablet om rechtstreeks naar ons YouTube-kanaal met duidelijke productvideo's te gaan.

De interactieve PDF-versie van onze nieuwe productcatalogus biedt nog meer gemak: door op de individuele artikelnummers te klikken, krijgt u toegang tot een gedetailleerde beschrijving van de gewenste producten en de bijbehorende documenten op onze website.

Deze technische toevoegingen maken van deze productcatalogus een interactief naslagwerk, dat het voor u nog gemakkelijker maakt om het juiste product te kiezen. Met dit in gedachten wensen wij u veel succes met onze hoogwaardige schroeven en verheugen wij ons op de voortzetting van onze vertrouwensvolle samenwerking.

Met vriendelijke groeten uit het Zwarte Woud,
Uw HECO-team

HECO door de jaren heen

Het succesverhaal van de firma HECO begint in de privévertrekken van de knutselaar Karl Hettich uit het Duitse Schramberg. Hij vindt een buigautomaat uit voor de vervaardiging van echappementen die nodig zijn in de uurwerkindustrie van Schramberg. Na de vroege dood van hun vader breiden de zonen van Karl Hettich de florierende zaak uit.

In 1936 begint de firma Hettich ook met de productie van schroeven. Ludwig Hettich, een kleinzoon van de oprichter van de firma, licht in 1967 de schroefproductie uit de Franz Hettich KG en richt de firma Ludwig Hettich & Co. schroevenfabrik; dit is het allereerste begin van HECO!

Als Ludwig Hettich in 1975 sterft, neemt met de oudste zoon Stefan Hettich de vierde generatie de bedrijfsleiding op zich. Stefan Hettich zet in op de consequente ontwikkeling van het merk HECO en optimaliseert de productieprocessen en de logistiek. Sinds 2006 versterkt zijn broer Guido Hettich het HECO-team als tweede directielid van de onderneming.

Heden ontwikkelen, produceren en verkopen meer dan 400 medewerkers innovatieve schroeven en bevestigingselementen, die wereldwijd met succes ingezet worden en bekend staan om hun hoge kwaliteit en veiligheid.

4



Het hoofdkantoor en fabriek in Schramberg-Sulgen



Fabriek in Campia Turzii, Roemenië



Logistiek Centrum in Schramberg-Sulgen

1888

Karl Hettich vindt een buigapparaat uit voor echappementen en legt de basis voor een lange bedrijfstraditie



De start: de ankerhaken, geproduceerd op een door Karl Hettich ontwikkeld buigautomaat

1936

Het Hettich familiebedrijf begint met de productie van schroeven

1967

Ludwig Hettich licht de schroevenproductie uit de Franz Hettich KG en richt de Ludwig Hettich & Co. schroevenfabrik op

1971

Het bedrijf betreft het nieuw gebouwde productie- en administratiegebouw in Schramberg-Sulgen

1975

Na de dood van de oprichter van het bedrijf neemt met Stefan Hettich de volgende generatie de bedrijfsleiding van de firma HECO op zich

1978

Het bedrijf presenteert de spaanplaatschroef **HECO-FIX®**. Met deze schroef is ook het merk HECO geboren



Karl Hettich – Oprichter van de Hettich familieonderneming



Rond 1895 – eerste vestiging van het Hettich-familiebedrijf



Ludwig Hettich – Oprichter van de huidige onderneming HECO-schroeven GmbH & Co. KG



1967 – eerste vestiging van HECO-schroeven GmbH & Co. KG

1989

HECO richt een eigen gereedschapsmakerij als basis voor de ontwikkeling en productie van innovatieve schroeven

2000

Presentatie van de houtschroef **HECO-TOPIX®**

2010

Presentatie van de **HECO-UNIX-schroef**

2016

Presentatie van de nieuwe **MULTI-MONTI®-plus** schroefankers

1990

Presentatie van de eerste eigen ontwikkelde universeel schroef **HECO-FIX-plus®**

2004

Oprichting van HECO France sarl als verkooporganisatie in Frankrijk

2014

Inwijding van het nieuwe Logistiek Centrum in Schramberg-Sulgen

2020-2021

Vervanging van de huidige schroeflijnen door het nieuwe universele schroef assortiment **HECO-TOPIX®-plus**

1995

Presentatie van het schroefanker **MULTI-MONTI®**, waarvoor HECO later de innovatieprijs van de deelstaat Baden-Württemberg ontvangt

2009

Oprichting van de productie-onderneming S.C. HECO SCHROEVEN S.R.L. in Roemenië

2015

Introductie van de nieuw ontwikkelde **HECO-UFIX® MDF-schroef** en begin van samenwerking met **SFS Group AG**

2024

Introductie van het nieuwe assortiment **HECO-TOPIX®-plus vouldraadschroeven** voor constructief houtbouw, met lengtes tot 800 mm

Van professionals voor professionals

Wij zijn er om u de best mogelijke ondersteuning te bieden voor uw behoeften. Of u nu advies nodig heeft voor uw volgende project, technische problemen wilt oplossen of vragen hebt over onze "HCS" calculatiesoftware - wij zijn er om u te helpen. Ons toegewijde team van experts staat voor u klaar met uitgebreide expertise en jarenlange ervaring. We begrijpen dat uw tijd kostbaar is. Daarom hechten we veel belang aan snelle reactietijden en efficiënte oplossingen.



U kunt al onze diensten ook vinden op www.heco-schrauben.nl/Service

Voor berekeningen en adviesaanvragen kunt u contact opnemen:

Hotline: +49 (0)7422/989-300

E-Mail: office@lowie.nl



Calculatiesoftware en calculatieservice

De modules van de calculatiesoftware HECO-HCS 4.0 maken een kosten geoptimaliseerde planning van uw project mogelijk en ondersteunen u bij de professionele uitvoering van het werk. Onze specialisten voeren graag een berekeningscontrole direct voor u uit.

U vindt de ontwerpformulieren op onze website op www.heco-schrauben.nl/Service/Dimensionierung
Vul ze in en stuur ze naar anwendungsberatung@heco-schrauben.de

Meer informatie over de HECO-HCS 4.0 calculatiesoftware vindt u op pagina 8.



Downloadcentrum

Ons downloadcentrum biedt een centraal platform voor technische documenten, brochures, catalogi en goedkeuringen. Hier vindt u alle belangrijke informatie in een overzichtelijk formaat. Dankzij de intuïtieve zoek- en filterfunctie hebt u snel en eenvoudig toegang tot de documenten die u nodig heeft. Profiteer van onze service en maak uw project nog efficiënter!

U vindt het downloadcentrum op www.heco-schrauben.nl/Service/Download-centrum





Online productcatalogus

Ontdek onze online productcatalogus, uw uitgebreide hulpmiddel om de ideale schroef voor uw toepassing te vinden. Of u nu zoekt via een toepassing of direct naar een specifiek schroeftype, met de gebruiksvriendelijke navigatie en gedetailleerde productinformatie vindt u eenvoudig de juiste artikelen.

U vindt de online productcatalogus op
www.heco-schrauben.nl/Producten

7



BIM/CAD-database

In onze BIM/CAD-database kunnen gebruikers en constructeurs BIM-geschiedte CAD-gegevens in 2D en 3D vinden. De gegevens kunnen in bijna 100 verschillende formaten gratis worden gedownload, wat betekent dat alle gangbare CAD-systemen worden ondersteund. Bovendien zijn de productgegevens beschikbaar in twee detailniveaus (LOD).

U kunt de BIM/CAD-database vinden op:
www.heco-schrauben.nl/Service/BIM-CAD-database



HECO-HCS 4.0

Calculatie software

Product informatie

- Professionele rekenhulp
- Calculatie van HECO-producten
- Calculatie tools:
 - Plugdimensionering
 - Leuningbevestiging
 - Isolatiemateriaal op dakspanten
 - Bewijs opwaartse kracht
 - Dimensionering houtbouw
 - Geveldimensionering
- In totaal 17 verschillende calculatie tools
- Eenvoudige invoer
- Uitgewerkte berekening met schets
- Kosteloos als download verkrijgbaar

Professionele calculatie tools van HECO



Download



Calculatie tools

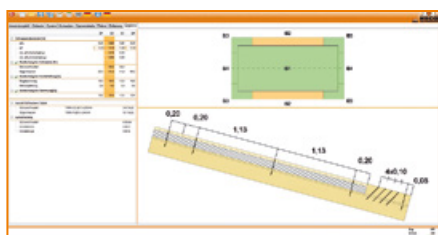

Isolatiemateriaal op dakspanten

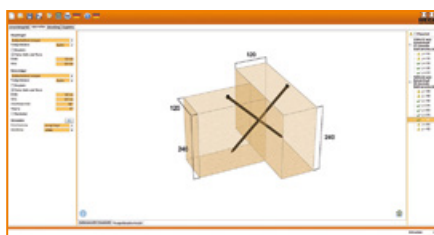

Dwarsbalk verbinding



Leuningbevestiging

9



Beschrijving:

HECO-HCS 4.0 calculatie software, als download via www.heco-schrauben.nl verkrijgbaar

Bewezen kwaliteit!

HECO-schroeven zijn wereldwijd het toppunt van veiligheid en betrouwbaarheid in de bevestigingstechniek. Om telkens te voldoen aan de eigen kwaliteitseisen, onderwerpen wij onze nieuwe ontwikkelingen aan uitgebreide testen, voordat wij ze op de markt brengen. Daarbij let HECO bij alle producten op een gelijkblijvend hoge kwaliteits- en veiligheidsstandaard en laat deze ook regelmatig certificeren door externe keuringsinstanties.

Een belangrijke grootheid in het kader van het goedkeuringsproces van schroeven is de „Europese Technische Goedkeuring“ (ETA) als algemeen erkend bewijs voor de technische prestatiebestendigheid van een bouwproduct.

De door technische beoordelingsinstantie (DIBt) afgegeven ETA-documenten maken voor ons als fabrikant de CE-markering van onze bevestigingsproducten en zo de ongehinderde toegang tot de Europese markt mogelijk. Samen met de algemeen bouwkundige goedkeuringen documenteren zij onze innovatiekracht en signaleren de klant dat hij op elk moment kan vertrouwen op de betrouwbaarheid en veiligheid van de HECO-producten.

Hierna stellen wij alle belangrijke logos aan u voor die in deze catalogus voor de afzonderlijke productgroepen van belang zijn. Zo krijgt u snel een overzicht van de goedkeuringen die onze schroeven hebben en vindt u snel het juiste product.



Europese Technische Goedkeuring (ETA)

Bij de verkoop van bevestigingsmiddelen in heel Europa moet in veel gevallen een CE-markering worden getoond. Basis van de noodzakelijke CE-overeenstemming is een Europese Technische Goedkeuring (ETA) die alle technische eigenschappen van een bouwproduct behandelt. De daarbij behorende prestatieverklaringen (DoP –Declaration of Performance) zijn beschikbaar voor alle producten.



Algemeen Bouwkundige goedkeuring / Algemene typegoedkeuring

De rode cirkel geeft producten en productgroepen aan waarvoor het “Duitse Institut für Bautechnik (DIBt)” een nationale (toepassings) goedkeuring heeft verleend. Met een algemene typegoedkeuring wordt de toepasbaarheid van het onderwerp in de zin van de bouwverordeningen van de deelstaten aangetoond. Een eventueel extra aangebracht Ü-symbool documenteert de overeenstemming met de in de goedkeuring gedefinieerde eisen en de bij het DIBt vastgelegde technische productspecificatie. Het vermeldt ook de externe bewakingsinstantie die de naleving van de specificaties controleert.



SKH-certificering

Het SKH-keurmerk is een keuringscertificaat dat op de Nederlandse markt wordt aangetroffen. De Stichting Keuringsbureau Hout (SKH) beoogt met het toekennen ervan verbetering van de kwaliteitsborging in die bouwsectoren waar hout en houtproducten worden gebruikt. Producten met SKH-keurmerk signaleren dat de fabrikant zich heeft onderworpen aan het Nederlandse keuringsstelsel en heeft voldaan aan de daar geldende eisen.



Sprinkler-Logo

De met het sprinkler-logo gemarkeerde MULTI-MONTI-plus schroefankers voldoen aan de eisen voor de bevestiging van leidingen voor blusinstallaties aan betonnen plafonds volgens de VdS-richtlijn CEA 4001. Het sprinklerlogo wordt door de “Fachverband Werkzeugindustrie” (FWI) ter beschikking gesteld aan fabrikanten van pluggen en bevestigingstechniek.

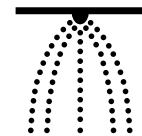

Brandwerendheidsklasse

De bouwproducten MULTI-MONTI-plus schroefankers worden op basis van hun brandwerendheid ingedeeld in verschillende brandwerendheidsklassen. De rode vlam-symbolen en de toevoeging “R120” geven aan dat de producten zeer brandwerend zijn. Dit bevestigt dat een gemonteerd onderdeel (bijv. een kabelgoot) in geval van brand gedurende 120 minuten zijn draagvermogen behoudt.



Seismische beoordeling

Het seismische symbool geeft de betrouwbaarheid van onze MULTI-MONTI plus-schroefankers weer, in geval van seismische effecten. De geschiktheid en prestaties van de schroefankers in de seismische prestatie categorieën C1/C2 maken deel uit van de overeenkomstige ETA-goedkeuringen.



Meer informatie

Alle goedkeuringsbewijzen en prestatieverklaringen van onze gecertificeerde HECO-producten kunnen ook online worden opgevraagd: <https://www.heco-schrauben.nl/Service/Download-centrum>



Downloadcentrum

Meer informatie over de producten vindt u op:

www.youtube.com/HECO-schroeven

of direct bij HECO op:

E-Mail: office@lowie.nl

Telefoon toepassingstechniek bij Lowie: +31 (0) 35 – 541 59 58

Toepassingstechniek bij HECO: +49 (0) 74 22 – 989 300



YouTube-Channel



HECO-verpakkingen

Product informatie

VARIANTA verpakkingen

- Opening aan de voorkant als schuiver
- Opening boven in verpakking via perforatie
- Etiket aan de voorkant met plakstrip, (beveiliging)

O-verpakking

- Stabiele kwalitatief hoogwaardige verpakking
- Uniforme breedte en hoogte
- Logisch verpakkingssysteem: tot en met schroeflengte 500 mm in omverpakking geleverd

SKV-kleinverpakking

- Opening in principe aan de zijkant links met vingergat
- Etiket aan de voorkant met plakstrip, (beveiliging)
- EAN-code boven (bij SKV 5 aan de voorkant)

Kunststof dozen

- Weerbestendig
- Afsluitbaar met een deksel
- Herbruikbaar
- Optimale handling op bouwplaatsen

Gewoon goed verpakt

Voor handel, handwerk, industrie of doe-het-zelvers – HECO® biedt u een uniform en uitgebreid assortiment aan kleine, industrie- en DIY-verpakkingen.

Goed verpakt in de geoptimaliseerde omverpakkingen

Voor de HECO-verpakkingen is er een consistent omdoosconcept: de afmetingen van de omdozen zijn afgestemd op de standaardmaat van de Europallet. De breedte is altijd 20 cm, en de lengte van de doos is variabel met 30, 40 of 60 cm, evenals de hoogte van de doos. Elk artikel is toegewezen aan een passende omdoos, wat het aantal verpakkingseenheden per omdoos en de hoeveelheid schroeven per omdoos of per pallet bepaalt.

Beschermd bij weer en wind

Dankzij de lakcoating van alle verpakkingen zijn deze extreem vochtbestendig en uitermate geschikt voor gebruik op de bouwplaats.

Verpakkingsvarianten:

- VARIANTA verpakking (VARIANTA)
- O-verpakking (O-BOX)
- SKV-kleinverpakking (SKV)
- Kunststof dozen



Goed verpakt dankzij het uniforme omverpakkingconcept.



Extreem vochtbestendig dankzij lakcoating.

VARIANTA verpakking



Verpakkingsnummer	Verpakking			Omverpakking				
	Lengte [mm]	Breedte [mm]	Hoogte [mm]	Omverpakingsnummer	Lengte [mm]	Breedte [mm]	Hoogte [mm]	Verpakkingen per omverpakking
VAR 1	85	90	75	UK 3	400	200	105	10
VAR 2	150	90	75	UK 5	400	200	160	10
VAR 3	185	90	75	UK 3/UK 6	400	200	105/200	5/10
VAR 4	230	90	75	UK 1	400	200	250	10

O-verpakking



Verpakkingsnummer	Verpakking			Omverpakking				
	Lengte [mm]	Breedte [mm]	Hoogte [mm]	Omverpakingsnummer	Lengte [mm]	Breedte [mm]	Hoogte [mm]	Verpakkingen per omverpakking
O150	150	90	75	UK 5	400	200	160	10
O185	185	90	75	UK 3/UK 6	400	200	105/200	5/10
O190	190	90	92	UK 3	400	200	105	4
O290	290	90	92	UK 7	300	200	200	4
O390	390	90	92	UK 3/UK 6	400	200	105/200	2/4
O490	490	90	92	UK 8	600	200	200	4
O590	590	90	92	UK 8	600	200	200	4
O850	850	90	92	-	-	-	-	-
O1150	1150	90	92	-	-	-	-	-

SKV-kleinverpakking



Verpakkingsnummer	Verpakking			Omverpakking				
	Lengte [mm]	Breedte [mm]	Hoogte [mm]	Omverpakingsnummer	Lengte [mm]	Breedte [mm]	Hoogte [mm]	Verpakkingen per omverpakking
SKV 1	45	60	45	UK 2	400	200	65	24
SKV 2	60	60	45	UK 2	400	200	65	24
SKV 3	85	60	45	UK 3	400	200	105	24
SKV 4	75	90	60	UK 4	400	200	135	20
SKV 5	85	90	75	UK 6	400	200	200	20

Kunststof dozen



Verpakkingsnummer	Verpakking			Omverpakking				
	Lengte [mm]	Breedte [mm]	Hoogte [mm]	Omverpakingsnummer	Lengte [mm]	Breedte [mm]	Hoogte [mm]	Verpakkingen per omverpakking
H1	140	122	85	UK 9	325	260	185	8
H2	140	122	126	UK 10	325	260	140	4
H3	198	198	140	UK 6	400	200	200	2

Verpakkingsetiketten

Professionele gebruikers die vertrouwen op producten van hoge kwaliteit hechten veel belang aan een duidelijke en betrouwbare etikettering op de verpakking. Deze etikettering biedt zekerheid bij de aankoop en maakt eenvoudige identificatie op de bouwplaats mogelijk. HECO verpakkingsetiketten zijn speciaal ontworpen om een optimale balans te bieden tussen volledigheid van informatie en een duidelijke structuur.

Productafbeeldingen in kleur

De labels bevatten grote, gekleurde productafbeeldingen die dienen als praktische identificatie. Kenmerken zoals kop, schroefdraad, aandrijving en oppervlak zijn op het eerste gezicht zichtbaar.

Schroefafmeting

De afmetingen en verpakkingshoeveelheid van de schroeven worden gemarkeerd als belangrijke selectiecriteria in een oranje gekleurd kader.

Aandrijving/aandrijfgrootte

Een kleurcoderingsysteem om de aandrijfmaten te identificeren maakt het gemakkelijker om de schroef aan de juiste HECO-bit toe te wijzen en is geïntegreerd op het label.

QR-code voor aanvullende productinformatie

Voor gedetailleerde technische informatie die niet volledig kan worden weergegeven op een gedrukt label, bieden de labels gemakkelijk toegang tot meer inhoud via een QR-code. Een scan met een smartphone geeft toegang tot beschrijvingen, productvoordelen, technische details en downloads zoals goedkeuringen en prestatieverklaringen. De toegang is apparaatnafhankelijk, zonder een speciale app, dus een QR-codescanner en internettoegang zijn voldoende.

Overzicht over de inhoud van de etiketten

The diagram shows a rectangular label for a HECO TOPIX-plus screw. The label is divided into several sections:

- Top Left:** A detailed image of the screw with the text "Art.Nr. 61180" next to it.
- Top Center:** The product name "HECO-TOPIX-plus" in large bold letters, followed by "Senkkopf, Teilgewinde" and "HTP-T-CS-PT-6,0x200/72".
- Top Right:** The HECO SCHRAUBEN logo.
- Center:** A large orange box containing the quantity "100" and the dimensions "6,0 x 200".
- Right Side:** A yellow circle with a star icon labeled "HD-30", and a blue box labeled "ZINK blau, A3K".
- Bottom Left:** A QR code and a barcode.
- Bottom Center:** The barcode number "4 019787 611800".
- Bottom Right:** The text "MADE IN EUROPE", "Produced by HECO", and "Batch:".

Callouts from the surrounding text explain the following elements:

- Productafbeelding:** Snelle identificatie dankzij gedetailleerde, afbeelding in kleur (points to the screw image).
- Artikelnummer:** Eenduidig identificatienummer van het artikel (points to "Art.Nr. 61180").
- QR-code:** Webweergave van gedetailleerde productinformatie (points to the QR code).
- Goedkeuringen/certificaten:** Gedeelte voor goedkeuringsinformatie (points to the CE and SKH logos).
- Afmeting van de schroef:** Diameter x lengte (mm) (points to the "6,0 x 200" dimensions).
- Hoeveelheid:** Aantal schroeven per verpakking (points to the "100" quantity).
- Productfamilie / -variant:** Basisinformatie over het artikel (points to the "HECO-TOPIX-plus" name).
- Aandrijving:** Type en maat, kleurtoewijzing aan bit (points to the "HD-30" icon).
- Oppervlakte/materiaal:** Eenvoudige onderscheiding dankzij gekleurde achtergrond: blauw = blauw verzinkt, geel = geel verzinkt, groen = rvs A2, rood = rvs A4, grijs = HP-coating (points to the "ZINK blau, A3K" section).

Structuur van de catalogus

Om het je gemakkelijker te maken je weg te vinden in de catalogus, hebben we ons assortiment onderverdeeld in 6 groepen. Ze zijn gesorteerd op toepassingsgebieden.

Kleurselectie en bijbehorend toepassingsgebied

- Universele houtschroeven
- Houtbouwschroeven
- Schroeven voor beton en metselwerk

Voor een snelle oriëntatie zijn de afzonderlijke hoofdstukken gemarkeerd met een kleuren balk en een korte beschrijving bovenaan de pagina.

- Terrasbouw
- Schroeven assortimenten
- Bits en bithouders

Kleurcodering voor aandrijf-/bitgrootten

- ★ T-10/HD-10
- ★ T-15/HD-15
- ★ T-20/HD-20
- ★ T-25/HD-25
- ★ T-30/HD-30
- ★ T-40/HD-40
- ★ T-45/HD-45
- ★ T-50/HD-50
- + PZD-1
- + PZD-2
- + PZD-3

Artikel tabel: Universele houtschroeven

↓ Toepassingsgebied
↓ Uitgebreide productomschrijving
↓ Toewijzing van de HECO-TOPIX-plus-eigenschappen

Universeel		HECO-TOPIX-plus, platverzonken kop							
		Uitvoering: platverzonken kop met freeshotles Aandrijving: HECO-Drive * Draadtype: deeldraad Materiaal: koolstofstaal Oppervlakte: verzinkt blauw, A3K CHROME (VI) FREE Kleurcode op het HECO-etiket							
Almeting d x l [mm]	Draadlengte lg [mm]	Kopdiameter dk [mm]	Aandrijving	ETA	Artikelnummer	Aantal per verpakking [st.]	Type verpakking	Aantal per omverpakking [st.]	
3,0	30	18	5,9	T-10	60123	1.000	VARIANTA	10.000	
	35	21	5,9	T-10	60144	1.000	VARIANTA	10.000	
	40	24	5,9	T-10	60158	500	VARIANTA	5.000	
	45	27	5,9	T-10	63518	200	SKV	4.000	
	45	27	5,9	T-10	60169	500	VARIANTA	5.000	
3,5	25	15	7,3	HD-20	60236	1.000	VARIANTA	10.000	
	30	18	7,3	HD-20	60261	1.000	VARIANTA	10.000	
	35	21	7,3	HD-20	60284	1.000	VARIANTA	10.000	
	40	24	7,3	HD-20	60309	500	VARIANTA	5.000	
	45	27	7,3	HD-20	60326	500	VARIANTA	5.000	
4,0	50	30	7,3	HD-20	60343	500	VARIANTA	5.000	
	30	18	7,9	HD-20	60434	1.000	VARIANTA	10.000	
	35	21	7,9	HD-20	60458	500	VARIANTA	5.000	

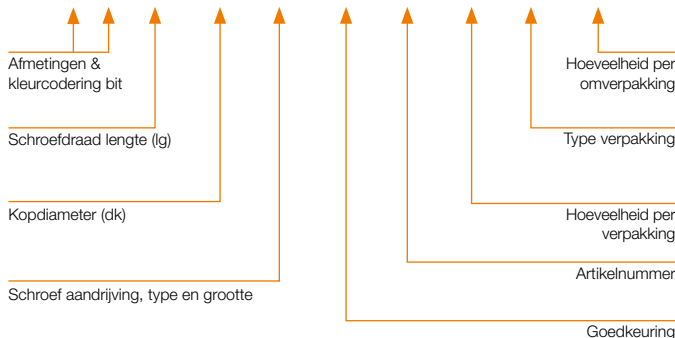

Artikel tabel: Betonschroeven

↓ Toepassingsgebied
↓ Uitgebreide productomschrijving

Beton		MULTI-MONTI-plus SS, zeskantkop							
		Uitvoering: MMS-plus SS, zeskantkop met aangepaste ring Aandrijving: zeskantkop Materiaal: koolstofstaal Oppervlakte: verzinkt blauw, A2K CHROME (VI) FREE Kleurcode op het HECO-etiket							
Almeting d x l [mm]	Boor-Ø d [mm]	Klemdikte L [mm]	Kopdiameter dk [mm]	Aandrijving	ETA	Artikelnummer	Aantal per verpakking [st.]	Type verpakking	Aantal per omverpakking [st.]
6,0	40	5,0	5/15	11,0	SW-8	48381	100	O-BOX	1.000
	50	5,0	5/15(25)	11,0	SW-8	48383	100	O-BOX	1.000
	60	5,0	15/25(35)	11,0	SW-8	48385	100	O-BOX	1.000
	70	5,0	25/35(45)	11,0	SW-8	48387	100	O-BOX	1.000
	80	5,0	35/45(55)	11,0	SW-8	49816	50	O-BOX	500
7,5	35	6,0	1/10	14,0	SW-10	49846	100	O-BOX	1.000
	40	6,0	5/15	14,0	SW-10	48389	100	O-BOX	1.000
	50	6,0	15/25	14,0	SW-10	48391	50	O-BOX	500
	60	6,0	5/25(35)	14,0	SW-10	48393	50	O-BOX	500
	70	6,0	15/35(45)	14,0	SW-10	48395	50	O-BOX	500
	80	6,0	25/45(55)	14,0	SW-10	48397	50	O-BOX	500
	100	6,0	45/65(75)	14,0	SW-10	49817	50	O-BOX	500
120	6,0	65/85(95)	14,0	SW-10	49819	50	O-BOX	400	

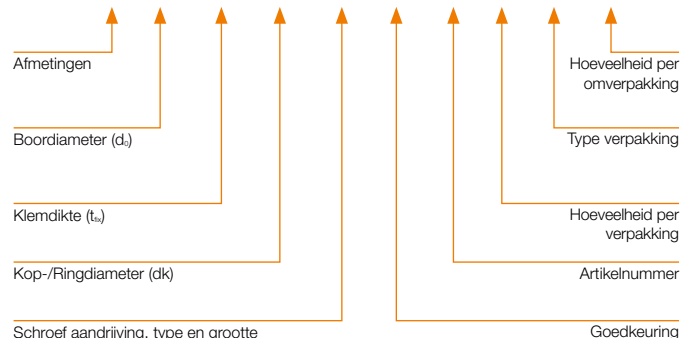





Universele houtschroeven

24



HECO-TOPIX-plus, platverzonken kop met freesholtes

28

HECO-Drive, voldraad	verzinkt blauw, A3K		28
	verzinkt geel, A3L		34
	roestvaststaal A2 1.4567		36
	verzinkt zwart, A3T NIEUW		38

HECO-Drive, deeldraad	verzinkt blauw, A3K		40
	verzinkt geel, A3L		42
	roestvaststaal A2 1.4567		44
	verzinkt zwart, A3T NIEUW		46

Pozi-Drive, voldraad	verzinkt blauw, A3K		48
	verzinkt geel, A3L		53
	roestvaststaal A2 1.4567		55

Pozi-Drive, deeldraad	verzinkt blauw, A3K		57
	verzinkt geel, A3L		60

HECO-TOPIX-plus, kleine platverzonken kop

62

Pozi-Drive, voldraad	verzinkt blauw, A3K		62
----------------------	---------------------	--	----

HECO-TOPIX-plus, platverzonken kop met kogatboring 2,4 mm

63

Pozi-Drive, voldraad	verzinkt blauw, A3K		63
----------------------	---------------------	--	----

HECO-TOPIX-plus, rondkop

64

T-Drive, voldraad	verzinkt blauw, A3K		64
	roestvaststaal A2 1.4567		66
Pozi-Drive, voldraad	verzinkt blauw, A3K		67
	roestvaststaal A2 1.4567		72

HECO-TOPIX-plus, verzonken lenskop met freesholtes

74

HECO-/Pozi-Drive, voldraad	roestvaststaal A2 1.4567		74
----------------------------	--------------------------	--	----

HECO-TOPIX-plus Achterwandschroef

























76



















T-/Pozi-Drive, voldraad	verzinkt blauw, A3K		76
-------------------------	---------------------	--	----







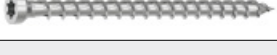





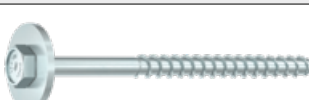

HECO-TOPIX-plus Vloerplaatschroef











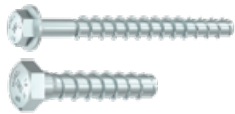

78













HECO-Drive, voldraad	verzinkt blauw, A3K		79
----------------------	---------------------	--	----

HECO-TOPIX-plus Vloerschroef			80
Verzonken lenskop, T-Drive, voldraad	verzinkt blauw, A3K		 81
	roestvaststaal A2 1.4567		 82
Verzonken cilinderkop, T-Drive, voldraad	roestvaststaal A2 1.4567		 82
HECO-TOPIX-plus Gevelschroef			84
HECO-Drive, voldraad	roestvaststaal A2 1.4567		 85
HECO-TOPIX-plus Scharnierschroef			86
T-/Pozi-Drive, voldraad, Ø3,5 mm	verzinkt blauw, A3K		 87
HECO-/Pozi-Drive, voldraad, Ø4,5 mm	verzinkt blauw, A3K		 88/89
	roestvaststaal A2 1.4567		 88/89
HECO-TOPIX-plus Glaslatschroef			90
T-Drive, deeldraad	verzinkt blauw, A3K		 91
	verzinkt geel, A3L		 91
	roestvaststaal A2 1.4567		 92
HECO-UFIX MDF-schroef			94
HECO-Drive, deeldraad	verzinkt blauw, A2K		 95
Accessoires voor universele houtschroeven			96
Plastic afdekkapjes	versch. aandrijvingstypen		 97
Houtbouwschroeven			98
HECO-TOPIX-plus, platverzonken kop met freesholtes			102
HECO-Drive, voldraad	verzinkt blauw, A3K		 102
	roestvaststaal A2 1.4567		 105
HECO-Drive, deeldraad	verzinkt blauw, A3K		 106
	roestvaststaal A2 1.4567		 109
HECO-TOPIX-plus, cilinderkop			110
T-Drive, voldraad	verzinkt blauw, A3K		 111
HECO-TOPIX-plus, combizeskantkop			112
Zeskantkop + T-Drive, voldraad	verzinkt blauw, A3K		 112
Zeskantkop + T-Drive, deeldraad	verzinkt blauw, A3K		 113

HECO-TOPIX-plus, tellerkop			114
T-Drive, deeldraad	verzinkt blauw, A3K		115
	roestvaststaal A2 1.4567		116
T-Drive, voldraad	verzinkt blauw, A3K		118
	roestvaststaal A2 1.4567		119
HECO-TOPIX-plus, tellerkop XL			120
Tellerkop XL, T-Drive, deeldraad	verzinkt blauw, A3K		120
HECO-TOPIX-plus CombiConnect			122
T-Drive, CC-draad	verzinkt blauw, A3K		124
HECO-TOPIX-plus Therm			126
HECO-Drive, onderkopdraad	verzinkt blauw, A3K		127
HECO-TOPIX-plus T Solar			128
T-Drive, onderkopdraad	roestvaststaal A2 1.4567		129
HECO-TOPIX-plus TCS, platverzonken kop met freesribben 60°			130
HECO-Drive, voldraad	verzinkt blauw, A3K		131
HECO-Drive, deeldraad	verzinkt blauw, A3K		131
HECO-TOPIX-plus Paalschroef			132
Tellerkop, T-Drive, voldraad	HP-coating		133
HECO-TOPIX-plus Verbindingsschroeven			134
Tellerkop, T-Drive, voldraad	verzinkt blauw, A3K		135
Platverzonken kop, HECO-Drive, voldraad	verzinkt blauw, A3K		135
HECO-TOPIX-plus Vloerplaatschroef			136
HECO-Drive, voldraad	verzinkt blauw, A3K		137
HECO-TOPIX-plus Vloerschroef			138
Verzonken lenskop, T-Drive, voldraad	verzinkt blauw, A3K		139
	roestvaststaal A2 1.4567		139
Verzonken cilinderkop, T-Drive, voldraad	roestvaststaal A2 1.4567		140
HECO-TOPIX-plus Gevelschroef			142
HECO-Drive, voldraad	roestvaststaal A2 1.4567		143

HECO-WR Voldraadschroef			144
T-Drive, voldraad	Durocoat		145
HECO-WS Zelfborende stalen deugel			146
T-Drive, onderkopdraad	verzinkt blauw, A2K		147
HECO-WB Draadstang			148
Zonder aandrijving, voldraad	verzinkt blauw, A2K	 NIEUW	149
HECO-VB Hout-beton-verbindingsschroef			150
TX-aandrijving E8, deeldraad	verzinkt blauw, A2K		151
MULTI-MONTI-TimberConnect			154
MMS-TC, T-Drive	verzinkt blauw, A2K		154
MULTI-MONTI-plus, zeskantkop, met sluitring			155
MMS-plus S, met sluitring DIN 440	verzinkt blauw, A2K		155
MULTI-MONTI-plus, platverzonken kop			156
MMS-plus F, T-Drive	verzinkt blauw, A2K		157
MULTI-MONTI-plus Therm			158
MMS-plus Therm, T-Drive	verzinkt blauw, A2K		159
Accessoires voor HECO-Houtbouwschroeven			160
HECO-PowerLock Houtbouwschroevenhouder	HECO-PowerLock, bits en adapters		160
Montageaccessoires voor HECO-WS stalen deugels	Montagegereedschappen, bithouders en vervangingsbits		161
Montageaccessoires voor HECO-WB draadstangen	Inschroefhulzen en boorsystemen	 NIEUW	162
Montageaccessoires voor HECO-VB Hout-beton-verbindingsschroeven	Montagegereedschappen en vervangingsbits		164
Zetgereedschap voor MULTI-MONTI-TimberConnect	voor MMS-TimberConnect met Ø 7,5, Ø 10 en Ø 12 mm		165
Onderlegschilden voor HECO-TOPIX-plus schroeven met platverzonken kop	Onderlegschilden, Ø 25 mm Onderlegschilden, Ø 30 mm		166
Inschroefhulp voor HECO-TOPIX-plus houtbouwschroeven	voor schroefverbindingen van 60° en 45°		167

Schroeven voor beton en metselwerk			168
MULTI-MONTI-plus SS, zeskantkop			174
MMS-plus SS/MMS-SS, met aangepaste ring MMS-plus S Zwaarlastanker	verzinkt blauw, A2K of HP-coating		174–176
MULTI-MONTI-plus S, zeskantkop, met sluitring			177
MMS-plus S, met sluitring DIN 440	verzinkt blauw, A2K		177
MULTI-MONTI-plus V, Voorsteekanker			178
MMS-plus V, met metr. buitendraad	verzinkt blauw, A2K		178
MULTI-MONTI-plus F, platverzonken kop			179
MMS-plus F, T-Drive	verzinkt blauw, A2K		179
MULTI-MONTI-plus MS, Montagerailschroef			180
MMS-plus MS, T-Drive	verzinkt blauw, A2K		180
MULTI-MONTI-plus ST, Stokanker			181
MMS-plus ST, met metr. buitendraad	verzinkt blauw, A2K		181
MULTI-MONTI-plus I, Binnendraadanker			182
MMS-plus I, met metr. buitendraad	verzinkt blauw, A2K		182
MULTI-MONTI-plus P, rondkop (PanHead)			183
MMS-plus P, T-Drive	verzinkt blauw, A2K		183
MULTI-MONTI-plus KS, Kabelklemschroef			184
MMS-plus KS, T-Drive	verzinkt blauw, A2K		184
MULTI-MONTI-plus R, Ooganker			184
MMS-plus R	verzinkt blauw, A2K		184
MULTI-MONTI-TimberConnect			186
MMS-TC, T-Drive	verzinkt blauw, A2K		187
MULTI-MONTI-plus SSK, Schorenanker			188
MMS-plus SSK, met aangepaste ring en conus	verzinkt blauw, A2K		189
MULTI-MONTI-plus Therm			190
MMS-plus Therm, T-Drive	verzinkt blauw, A2K		191

MULTI-MONTI-plus SS, zeskantkop, roestvaststaal A4			193
MMS-plus SS, met aangepaste ring	roestvaststaal A4 1.4401		193
MULTI-MONTI-plus F, platverzonken kop, roestvaststaal A4			194
MMS-plus F, T-Drive	roestvaststaal A4 1.4401		194
MULTI-MONTI-plus P, rondkop (PanHead), roestvaststaal A4			195
MMS-plus P, T-Drive	roestvaststaal A4 1.4401		195
MULTI-MONTI-plus MS, Montagerailschroef, roestvaststaal A4			195
MMS-plus MS, T-Drive	roestvaststaal A4 1.4578	 NIEUW	195
Accessoires voor MULTI-MONTI-plus			196
MULTI-MONTI-plus seismische kits	voor verankering in beton onder seismische belasting C2		197
Zetgereedschappen voor MULTI-MONTI-TimberConnect	voor MMS-TimberConnect met Ø7,5, Ø10 en Ø12 mm		198
Meethulzen voor meervoudig gebruik van de MULTI-MONTI®-plus	voor MMS-plus met Ø10, Ø12, Ø16 en Ø20 mm		199
Terrasbouw			200
Vlonderschroef, platverzonken kop met freesribben			202
HECO-Drive, deeldraad	roestvaststaal A2 1.4567 / A4 1.4578		203
Vlonderschroef, verzonken lenskop			204
HECO-Drive, onderkopdraad	roestvaststaal A2 1.4567 / A4 1.4578		205
Terrasbouw accessoires			206
HECO-Vlondergeleidersets	kleine set met middengeleider, grote set met middengeleider, kleine set met randgeleider		207
HECO-Clipperset	HECO-Clipper met HECO-TOPIX-plus clipperschroeven in roestvaststaal A2		208
HECO-Vlonderpads	Vlonderpads 3, 8 en 20 mm		209
HECO-Stelvoetjes	Stelvoet, hoogte: 35–70 mm Stelvoet, hoogte: 65–155 mm		210

HECO-Afstandhouders	Afstandhouders 3, 5 en 7 mm		211
HECO-Spanner	Spanner voor vlonderplanken met drie afstandhouders		212
HECO-Vlonderboor	Vonderboor en vervangende boren		213

Schroeven assortimenten

214

HECO-Assortimentskoffers

216

HECO-TOPIX-plus Assortimentskoffer 3005, L-BOXX 102	met 3.005 schroeven, geladen en leeg		217
HECO-TOPIX-plus Assortimentskoffer 1760, Systainer ³ M137	met 1.760 schroeven, geladen en leeg		218
HECO-TOPIX-plus Assortimentskoffer 700, L-BOXX Mini	met 700 schroeven, geladen en leeg, met en zonder transparant deksel		219
HECO-Assortimentskoffer, L-BOXX 283	leeg, zonder inzetbakjes		220
HECO-Assortimentskoffer, Systainer ³ M237	leeg, zonder dieptrekinzet		220

HECO-Profisets







221

HECO-TOPIX-plus Profiset „Timmerman“	1.650 schroeven, incl. HECO-Bit-Selector		221
HECO-TOPIX-plus Profiset „Schrijnwerker“	3.700 schroeven, incl. HECO-Bit-Selector		221

HECO-Gereedschapstas

223

HECO ProClick Tool Bag M	HECO-ProClick Tool Bag M gereedschapstas, leeg, compatibel met L-BOXX		223
--------------------------	---	---	-----

Bits en bithouders		224
Bits		226
Schroefbits en bitsets	Bits 25, 70 en 120 mm HECO- en Pozi-Drive, HECO-Bit-Selector	 227
Toonbankdisplays en blistertrays met HECO-Drive bits	met standaardbits 25 mm of lange bits 70 mm	 228
Bithouders en adapters		229
HECO-ClicFix snelwisselhouder	magnetisch, vorm E 6,3	 229
HECO-MagicFlip magnetische bithouder	met sterke ringmagneet voor zware houtbouwschroeven	 229
HECO-Stubby Mini-schroevendraaier	met 6-delige bitmagazijn in handvat	 229
Boorhouder adapter MK3	MK3 – 1/2" MK3 – 11,5 mm	 229
HECO-PowerLock Houtbouwschroevhouder	HECO-PowerLock, bits en adapters	 230



Universele houtschroeven

SCHROEVEN

HECO-TOPIX-plus, platverzonken kop	28
HECO-TOPIX-plus, kleine platverzonken kop	62
HECO-TOPIX-plus, platverzonken kop met kopgatboring	63
HECO-TOPIX-plus, rondkop	64
HECO-TOPIX-plus, verzonken lenskop	74
HECO-TOPIX-plus, Achterwandschroef	76
HECO-TOPIX-plus, Vloerplaatschroef	78
HECO-TOPIX-plus, Vloerschroef	80
HECO-TOPIX-plus, Gevelschroef	84
HECO-TOPIX-plus, Scharnierschroef	86
HECO-TOPIX-plus, Glaslatschroef	90
HECO-UFIX, MDF-schroef	94

ACCESSOIRES

Plastic afdekkapjes	96
---------------------	----



HECO-TOPIX®-plus

Productinformatie

HECO-TOPIX-plus is een echte schroef highlight en verenigt gebundelde technologische knowhow en veel concrete voordelen voor de gebruiker in één type schroef. Het geheim: voor HECO-TOPIX-plus hebben wij de beste eigenschappen uit vier HECO-assortimenten bij elkaar gebracht!

Met de innovatieve eigenschappen HECO-Drive, GripFit, MagicClose, PerfectPitch, een nieuw, uniform bitmaat concept en hoogwaardige systeemtoebehoren is HECO-TOPIX-plus de perfecte schroef voor nagenoeg alle toepassingen.



Maakt het beste beter.

Platverzonken kop met freesholtes

Uitstekende freeseigenschappen in hout. Geen beschadiging van het oppervlak bij metalen beslag.

MagicClose®

Gepatenteerde voldraad trekt houten onderdelen spleetvrij samen zonder voorspannen

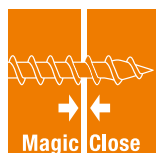

GripFit®

HECO-Drive maakt werken met één hand mogelijk



PerfectPitch®

Optimale schroefdraadspoed voor elke schroeflengte



HECO-TOPIX-plus-punt

Maakt voorbereiden overbodig en vermindert het risico van splijten van het hout



Video





Toepassingsvoorbeelden

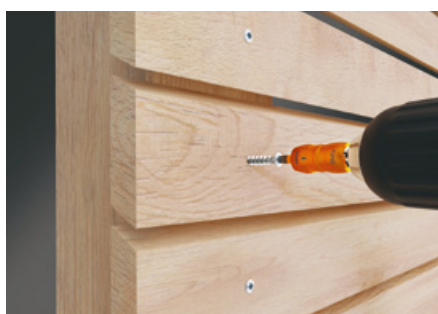

Gevelschroefverbinding



Kastschroefverbinding



Vastzetten van vloerplanken



Bevestiging van regelwerk t.b.v. installaties



OSB-beplating



Bevestiging van beslag



Uitvoering: platverzonken kop met freesholtes

Aandrijving: T-Drive

Draadtype: variabele voldraad

Materiaal: koolstofstaal

Oppervlakte: verzinkt blauw, A3K **CHROME (VI) FREE +**

Kleurcode op het HECO-etiket

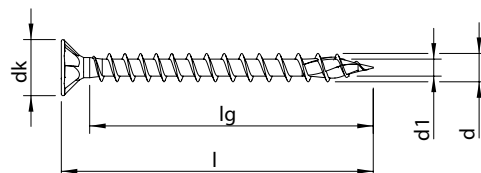

Afmeting d x l [mm]	Draadlengte lg [mm]	Kopdiameter dk [mm]	Aandrijving	ETA	Artikelnummer	Aantal per verpakking [st.]	Type verpakking	Aantal per omverpakking [st.]
3,0 	12	8	5,9	T-10	62685	200	SKV	4.800
	12	8	5,9	T-10	60039	1.000	VARIANTA	10.000
	16	12	5,9	T-10	60061	200	SKV	4.800
	16	12	5,9	T-10	60062	1.000	VARIANTA	10.000
	20	16	5,9	T-10	60081	200	SKV	4.800
	20	16	5,9	T-10	60082	1.000	VARIANTA	10.000
	25	21	5,9	T-10	60099	200	SKV	4.800
	25	21	5,9	T-10	60100	1.000	VARIANTA	10.000
	30	26	5,9	T-10	60116	200	SKV	4.800
	30	26	5,9	T-10	60117	1.000	VARIANTA	10.000
	35	31	5,9	T-10	60138	200	SKV	4.800
	35	31	5,9	T-10	60139	1.000	VARIANTA	10.000
	40	36	5,9	T-10	60151	200	SKV	4.000
	40	36	5,9	T-10	60152	500	VARIANTA	5.000
45	41	5,9	T-10	60162	200	SKV	4.000	
45	41	5,9	T-10	60163	500	VARIANTA	5.000	

Uitvoering: platverzonken kop met freesholtes

Aandrijving: HECO-Drive *

Draadtype: variabele voldraad

Materiaal: koolstofstaal

Oppervlakte: verzinkt blauw, A3K **CHROME (VI) FREE +**

Kleurcode op het HECO-etiket

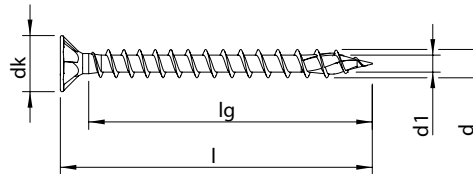

Afmeting d x l [mm]	Draadlengte lg [mm]	Kopdiameter dk [mm]	Aandrijving	ETA	Artikelnummer	Aantal per verpakking [st.]	Type verpakking	Aantal per omverpakking [st.]
3,5 	12	7	7,3	HD-20	60175	200	SKV	4.800
	12	7	7,3	HD-20	62686	500	VARIANTA	5.000
	12	7	7,3	HD-20	60176	1.000	VARIANTA	10.000
	15	10	7,3	HD-20	60186	200	SKV	4.800
	15	10	7,3	HD-20	60187	1.000	VARIANTA	10.000
	16	11	7,3	HD-20	60194	200	SKV	4.800
	16	11	7,3	HD-20	60195	1.000	VARIANTA	10.000
	20	15	7,3	HD-20	• 60213	200	SKV	4.800
	20	15	7,3	HD-20	• 60214	1.000	VARIANTA	10.000
	25	20	7,3	HD-20	• 60230	200	SKV	4.800
	25	20	7,3	HD-20	• 60231	1.000	VARIANTA	10.000
	30	25	7,3	HD-20	• 60255	200	SKV	4.800
	30	25	7,3	HD-20	• 60256	1.000	VARIANTA	10.000
	35	30	7,3	HD-20	• 60278	200	SKV	4.000
	35	30	7,3	HD-20	• 60279	1.000	VARIANTA	10.000
	40	35	7,3	HD-20	• 60302	200	SKV	4.000
	40	35	7,3	HD-20	• 60303	500	VARIANTA	5.000
	45	40	7,3	HD-20	• 60320	200	SKV	4.000
	45	40	7,3	HD-20	• 60321	500	VARIANTA	5.000
	50	45	7,3	HD-20	• 60336	200	SKV	4.000
50	45	7,3	HD-20	• 60337	500	VARIANTA	5.000	

* Alle schroeven met HECO-Drive zijn 100% compatibel met conventionele TX-bits.
Het GripFit-effect is alleen gegarandeerd bij gebruik met bijpassende HECO-Drive-bits.



Uitvoering: platverzonken kop met freesholtes

Aandrijving: HECO-Drive *

Draadtype: variabele voldraad

Materiaal: koolstofstaal

Oppervlakte: verzinkt blauw, A3K **CHROME (VI) FREE +**

Kleurcode op het HECO-etiket

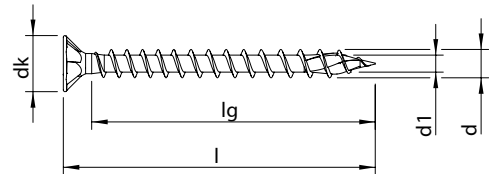

Afmeting d x l [mm]	Draadlengte lg [mm]	Kopdiameter dk [mm]	Aandrijving	ETA	Artikelnummer	Aantal per verpakking [st.]	Type verpakking	Aantal per omverpakking [st.]	
4,0 	15	10	7,9	HD-20	60364	200	SKV	4.800	
	15	10	7,9	HD-20	60365	1.000	VARIANTA	10.000	
	16	11	7,9	HD-20	60372	200	SKV	4.800	
	16	11	7,9	HD-20	60373	1.000	VARIANTA	10.000	
	20	15	7,9	HD-20	60389	200	SKV	4.800	
	20	15	7,9	HD-20	60390	1.000	VARIANTA	10.000	
	25	20	7,9	HD-20	•	60406	200	SKV	4.800
	25	20	7,9	HD-20	•	60407	1.000	VARIANTA	10.000
	30	25	7,9	HD-20	•	60428	200	SKV	4.800
	30	25	7,9	HD-20	•	60429	1.000	VARIANTA	10.000
	35	30	7,9	HD-20	•	60452	200	SKV	4.000
	35	30	7,9	HD-20	•	60453	500	VARIANTA	5.000
	40	35	7,9	HD-20	•	60475	200	SKV	4.000
	40	35	7,9	HD-20	•	60476	500	VARIANTA	5.000
	40	35	7,9	HD-20	•	60477	1.000	VARIANTA	10.000
	45	40	7,9	HD-20	•	60501	200	SKV	4.000
	45	40	7,9	HD-20	•	60502	500	VARIANTA	5.000
	50	45	7,9	HD-20	•	60525	200	SKV	4.000
	50	45	7,9	HD-20	•	60526	500	VARIANTA	5.000
	55	50	7,9	HD-20	•	60547	200	VARIANTA	2.000
60	55	7,9	HD-20	•	60556	200	VARIANTA	2.000	
70	65	7,9	HD-20	•	60570	200	VARIANTA	2.000	

* Alle schroeven met HECO-Drive zijn 100% compatibel met conventionele TX-bits.
Het GripFit-effect is alleen gegarandeerd bij gebruik met bijpassende HECO-Drive-bits.

Uitvoering: platverzonken kop met freesholtes

Aandrijving: HECO-Drive *

Draadtype: variabele voldraad

Materiaal: koolstofstaal

Oppervlakte: verzinkt blauw, A3K **CHROME (VI) FREE +**

Kleurcode op het HECO-etiket

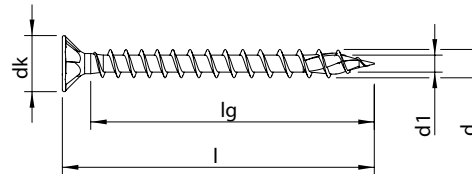

Afmeting d x l [mm]	Draadlengte lg [mm]	Kopdiameter dk [mm]	Aandrijving	ETA	Artikelnummer	Aantal per verpakking [st.]	Type verpakking	Aantal per omverpakking [st.]
4,5 	20	15	8,9	HD-20	60598	200	SKV	4.800
	20	15	8,9	HD-20	60599	1.000	VARIANTA	10.000
	25	20	8,9	HD-20	● 60616	200	SKV	4.800
	25	20	8,9	HD-20	● 60617	500	VARIANTA	5.000
	30	25	8,9	HD-20	● 60633	200	SKV	4.000
	30	25	8,9	HD-20/HD-25**	● 60634 / 62289 **	500	VARIANTA	5.000
	35	30	8,9	HD-20	● 60655	200	SKV	4.000
	35	30	8,9	HD-20/HD-25**	● 60656 / 62290 **	500	VARIANTA	5.000
	40	35	8,9	HD-20	● 60678	200	SKV	4.000
	40	35	8,9	HD-20/HD-25**	● 60679 / 62291 **	500	VARIANTA	5.000
	45	40	8,9	HD-20	● 60702	200	SKV	4.000
	45	40	8,9	HD-20/HD-25**	● 60703 / 62292 **	500	VARIANTA	5.000
	50	45	8,9	HD-20/HD-25**	● 60725 / 62293 **	200	VARIANTA	2.000
	55	50	8,9	HD-20	● 60742	200	VARIANTA	2.000
	60	55	8,9	HD-20/HD-25**	● 60755 / 62294 **	200	VARIANTA	2.000
	70	65	8,9	HD-20/HD-25**	● 60772 / 62295 **	200	VARIANTA	2.000
80	75	8,9	HD-20/HD-25**	● 60783 / 62296 **	200	VARIANTA	2.000	

* Alle schroeven met HECO-Drive zijn 100% compatibel met conventionele TX-bits.
Het GripFit-effect is alleen gegarandeerd bij gebruik met bijpassende HECO-Drive-bits.

** Alternatieve variant met aandrijving HD-25



Uitvoering: platverzonken kop met freesholtes

Aandrijving: HECO-Drive *

Draadtype: variabele voldraad

Materiaal: koolstofstaal

Oppervlakte: verzinkt blauw, A3K **CHROME (VI) FREE +**

Kleurcode op het HECO-etiket

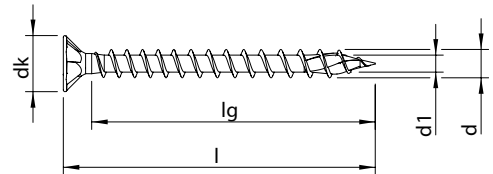

Afmeting d x l [mm]	Draadlengte lg [mm]	Kopdiameter dk [mm]	Aandrijving	ETA	Artikelnummer	Aantal per verpakking [st.]	Type verpakking	Aantal per omverpakking [st.]
5,0 	20	14	9,6	HD-20	60806	200	SKV	4.800
	20	14	9,6	HD-20	60807	500	VARIANTA	5.000
	25	19	9,6	HD-20	60818	200	SKV	4.000
	25	19	9,6	HD-20	60819	500	VARIANTA	5.000
	30	24	9,6	HD-20	● 60832	200	SKV	4.000
	30	24	9,6	HD-20/HD-25**	● 60833/62297**	500	VARIANTA	5.000
	35	29	9,6	HD-20	● 60851	200	SKV	4.000
	35	29	9,6	HD-20/HD-25**	● 60852/62298**	500	VARIANTA	5.000
	40	34	9,6	HD-20	● 60869	200	SKV	4.000
	40	34	9,6	HD-20/HD-25**	● 60870/62299**	500	VARIANTA	5.000
	45	39	9,6	HD-20/HD-25**	● 60887/62300**	200	VARIANTA	2.000
	50	44	9,6	HD-20/HD-25**	● 60900/62301**	200	VARIANTA	2.000
	55	49	9,6	HD-20	● 60914	200	VARIANTA	2.000
	60	54	9,6	HD-20/HD-25**	● 60924/62302**	200	VARIANTA	2.000
	70	64	9,6	HD-20/HD-25**	● 60940/62303**	200	VARIANTA	2.000
	80	74	9,6	HD-20/HD-25**	● 60953/62304**	200	VARIANTA	2.000
90	84	9,6	HD-20	● 60964	200	VARIANTA	2.000	
100	94	9,6	HD-20/HD-25**	● 60972/62305**	100	VARIANTA	1.000	
120	114	9,6	HD-20	● 60984	100	VARIANTA	1.000	

* Alle schroeven met HECO-Drive zijn 100% compatibel met conventionele TX-bits.

Het GripFit-effect is alleen gegarandeerd bij gebruik met bijpassende HECO-Drive-bits.

** Alternatieve variant met aandrijving HD-25

Uitvoering: platverzonken kop met freesholtes

Aandrijving: HECO-Drive *

Draadtype: variabele voldraad

Materiaal: koolstofstaal

Oppervlakte: verzinkt blauw, A3K **CHROME (VI) FREE +**

Kleurcode op het HECO-etiket

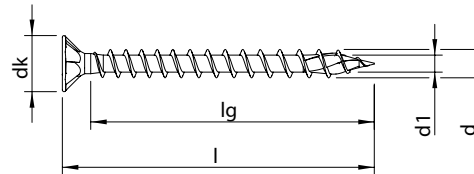

Afmeting d x l [mm]	Draadlengte lg [mm]	Kopdiameter dk [mm]	Aandrijving	ETA	Artikelnummer	Aantal per verpakking [st.]	Type verpakking	Aantal per omverpakking [st.]
6,0	30	23	11,7	HD-30	60996	200	VARIANTA	2.000
	35	28	11,7	HD-30	61002	200	VARIANTA	2.000
	40	33	11,7	HD-30	61006	200	VARIANTA	2.000
	45	38	11,7	HD-30	61020	200	VARIANTA	2.000
	50	43	11,7	HD-30	61028	200	VARIANTA	2.000
	60	53	11,7	HD-30	61051	200	VARIANTA	2.000
	70	63	11,7	HD-30	61072	200	VARIANTA	1.000
	80	73	11,7	HD-30	61084	100	VARIANTA	1.000
	90	83	11,7	HD-30	61098	100	VARIANTA	1.000
	100	93	11,7	HD-30	61107	100	VARIANTA	1.000
	110	103	11,7	HD-30	61121	100	VARIANTA	1.000
	120	113	11,7	HD-30	61128	100	VARIANTA	1.000
	140	133	11,7	HD-30	61144	100	VARIANTA	500
	160	153	11,7	HD-30	61160	100	O-BOX	800

* Alle schroeven met HECO-Drive zijn 100% compatibel met conventionele TX-bits.
Het GripFit-effect is alleen gegarandeerd bij gebruik met bijpassende HECO-Drive-bits.



Uitvoering: platverzonken kop met freesholtes

Aandrijving: HECO-Drive *

Draadtype: variabele voldraad

Materiaal: koolstofstaal

Oppervlakte: verzinkt geel, A3L **CHROME (VI) FREE +**

Kleurcode op het HECO-etiket

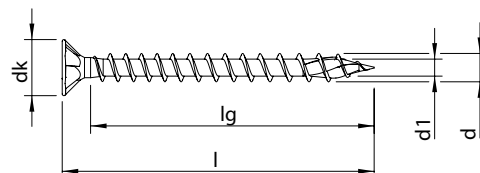

Afmeting d x l [mm]	Draadlengte lg [mm]	Kopdiameter dk [mm]	Aandrijving	ETA	Artikelnummer	Aantal per verpakking [st.]	Type verpakking	Aantal per omverpakking [st.]
3,5 ★	12	7	7,3	HD-20	60177	1.000	VARIANTA	10.000
	16	11	7,3	HD-20	60197	1.000	VARIANTA	10.000
	20	15	7,3	HD-20	60216	1.000	VARIANTA	10.000
	25	20	7,3	HD-20	60233	1.000	VARIANTA	10.000
	30	25	7,3	HD-20	60258	1.000	VARIANTA	10.000
	35	30	7,3	HD-20	60281	1.000	VARIANTA	10.000
	40	35	7,3	HD-20	60305	500	VARIANTA	5.000
	45	40	7,3	HD-20	60323	500	VARIANTA	5.000
	50	45	7,3	HD-20	60339	500	VARIANTA	5.000
4,0 ★	16	11	7,9	HD-20	60375	1.000	VARIANTA	10.000
	20	15	7,9	HD-20	60392	1.000	VARIANTA	10.000
	25	20	7,9	HD-20	60410	1.000	VARIANTA	10.000
	30	25	7,9	HD-20	60431	1.000	VARIANTA	10.000
	35	30	7,9	HD-20	60455	500	VARIANTA	5.000
	40	35	7,9	HD-20	60479	500	VARIANTA	5.000
	45	40	7,9	HD-20	60504	500	VARIANTA	5.000
	50	45	7,9	HD-20	60528	500	VARIANTA	5.000
	60	55	7,9	HD-20	60557	200	VARIANTA	2.000
70	65	7,9	HD-20	60571	200	VARIANTA	2.000	
4,5 ★	20	15	8,9	HD-20	60601	1.000	VARIANTA	10.000
	25	20	8,9	HD-20	60619	500	VARIANTA	5.000
	30	25	8,9	HD-20	60636	500	VARIANTA	5.000
	35	30	8,9	HD-20	60658	500	VARIANTA	5.000
	40	35	8,9	HD-20	60681	500	VARIANTA	5.000
	45	40	8,9	HD-20	60705	500	VARIANTA	5.000
	50	45	8,9	HD-20	60727	200	VARIANTA	2.000
	60	55	8,9	HD-20	60756	200	VARIANTA	2.000
	70	65	8,9	HD-20	60773	200	VARIANTA	2.000

* Alle schroeven met HECO-Drive zijn 100% compatibel met conventionele TX-bits.
Het GripFit-effect is alleen gegarandeerd bij gebruik met bijpassende HECO-Drive-bits.

Uitvoering: platverzonken kop met freesholtes

Aandrijving: HECO-Drive *



Draadtype: variabele voldraad

Materiaal: koolstofstaal

Oppervlakte: verzinkt geel, A3L **CHROME (VI) FREE** +

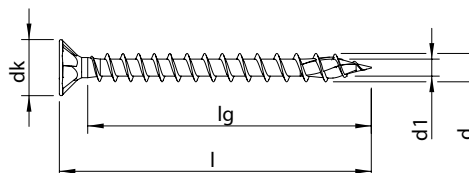
Kleurcode op het HECO-etiket



Afmeting d x l [mm]	Draadlengte lg [mm]	Kopdiameter dk [mm]	Aandrijving	ETA	Artikelnummer	Aantal per verpakking [st.]	Type verpakking	Aantal per omverpakking [st.]
5,0 	20	14	9,6	HD-20	60808	500	VARIANTA	5.000
	25	19	9,6	HD-20	60820	500	VARIANTA	5.000
	30	24	9,6	HD-20	60836	500	VARIANTA	5.000
	35	29	9,6	HD-20	60854	500	VARIANTA	5.000
	40	34	9,6	HD-20	60872	500	VARIANTA	5.000
	45	39	9,6	HD-20	60888	200	VARIANTA	2.000
	50	44	9,6	HD-20	60902	200	VARIANTA	2.000
	60	54	9,6	HD-20	60926	200	VARIANTA	2.000
	70	64	9,6	HD-20	60942	200	VARIANTA	2.000
6,0 	30	23	11,7	HD-30	60997	200	VARIANTA	2.000
	40	33	11,7	HD-30	61007	200	VARIANTA	2.000
	45	38	11,7	HD-30	61021	200	VARIANTA	2.000
	50	43	11,7	HD-30	61030	200	VARIANTA	2.000
	60	53	11,7	HD-30	61053	200	VARIANTA	2.000
	70	63	11,7	HD-30	61073	200	VARIANTA	1.000

* Alle schroeven met HECO-Drive zijn 100% compatibel met conventionele TX-bits.
Het GripFit-effect is alleen gegarandeerd bij gebruik met bijpassende HECO-Drive-bits.



Uitvoering: platverzonken kop met freesholtes

Aandrijving: HECO-Drive *



Draadtype: variabele voldraad

Materiaal: roestvaststaal A2 1.4567

Oppervlakte: blank, glijcoating

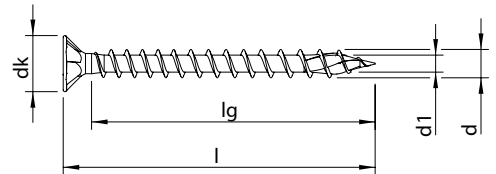
Kleurcode op het HECO-etiket



Afmeting d x l [mm]	Draadlengte lg [mm]	Kopdiameter dk [mm]	Aandrijving	ETA	Artikelnummer	Aantal per verpakking [st.]	Type verpakking	Aantal per omverpakking [st.]
3,0 	20	16	5,9	T-10	62013	200	SKV	4.800
	25	21	5,9	T-10	62014	200	SKV	4.800
	30	26	5,9	T-10	62015	200	SKV	4.800
	35	31	5,9	T-10	62016	200	SKV	4.800
3,5 	16	11	7,3	HD-20	62017	200	SKV	4.800
	20	15	7,3	HD-20	62018	200	SKV	4.800
	25	20	7,3	HD-20	62019	200	SKV	4.800
	30	25	7,3	HD-20	62020	200	SKV	4.800
	35	30	7,3	HD-20	62021	200	SKV	4.000
	40	35	7,3	HD-20	62022	200	SKV	4.000
4,0 	20	15	7,9	HD-20	62023	200	SKV	4.800
	25	20	7,9	HD-20	62024	200	SKV	4.800
	30	25	7,9	HD-20	62025	200	SKV	4.800
	35	30	7,9	HD-20	62026	200	SKV	4.000
	40	35	7,9	HD-20	62027	200	SKV	4.000
	45	40	7,9	HD-20	62028	200	SKV	4.000
	50	45	7,9	HD-20	62029	200	SKV	4.000

* Alle schroeven met HECO-Drive zijn 100% compatibel met conventionele TX-bits.
Het GripFit-effect is alleen gegarandeerd bij gebruik met bijpassende HECO-Drive-bits.

Uitvoering: platverzonken kop met freesholtes

Aandrijving: HECO-Drive *

Draadtype: variabele voldraad

Materiaal: roestvaststaal A2 1.4567

Oppervlakte: blank, glijcoating

Kleurcode op het HECO-etiket

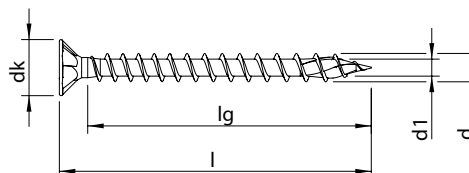

Afmeting d x l [mm]	Draadlengte lg [mm]	Kopdiameter dk [mm]	Aandrijving	ETA	Artikelnummer	Aantal per verpakking [st.]	Type verpakking	Aantal per omverpakking [st.]
4,5 ★	25	20	8,9	HD-20	62030	200	SKV	4.800
	30	25	8,9	HD-20/HD-25**	62031 / 62457**	200	SKV	4.000
	35	30	8,9	HD-20/HD-25**	62032 / 62458**	200	SKV	4.000
	40	35	8,9	HD-20/HD-25**	62033 / 62459**	200	SKV	4.000
	45	40	8,9	HD-20/HD-25**	62034 / 62460**	200	SKV	4.000
	50	45	8,9	HD-20/HD-25**	62035 / 62461**	200	VARIANTA	2.000
5,0 ★	25	19	9,6	HD-20	62036	200	SKV	4.000
	30	24	9,6	HD-20/HD-25**	62037 / 62462**	200	SKV	4.000
	35	29	9,6	HD-20/HD-25**	62038 / 62463**	200	SKV	4.000
	40	34	9,6	HD-20/HD-25**	62039 / 62464**	200	SKV	4.000
	45	39	9,6	HD-20/HD-25**	62040 / 62465**	200	VARIANTA	2.000
	50	44	9,6	HD-20/HD-25**	62041 / 62466**	200	VARIANTA	2.000
	60	54	9,6	HD-20/HD-25**	62042 / 62467**	200	VARIANTA	2.000
	70	64	9,6	HD-20/HD-25**	62043 / 62468**	200	VARIANTA	2.000
6,0 ★	60	53	11,7	HD-30	62045	200	VARIANTA	2.000
	80	73	11,7	HD-30	62046	100	VARIANTA	1.000

* Alle schroeven met HECO-Drive zijn 100% compatibel met conventionele TX-bits.
Het GripFit-effect is alleen gegarandeerd bij gebruik met bijpassende HECO-Drive-bits.

** Alternatieve variant met aandrijving HD-25



Uitvoering: platverzonken kop met freesholtes

Aandrijving: HECO-Drive*

Draadtype: variabele voldraad

Materiaal: koolstofstaal

Oppervlakte: verzinkt zwart, A3T **CHROME (VI) FREE +**

Kleurcode op het HECO-etiket

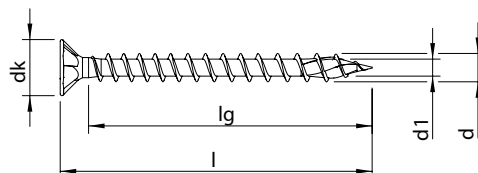

Afmeting d x l [mm]	Draadlengte lg [mm]	Kopdiameter dk [mm]	Aandrijving	ETA	Artikelnummer	Aantal per verpakking [st.]	Type verpakking	Aantal per omverpakking [st.]
4,0	16	11	7,9	HD-20	63514 NIEUW	200	SKV	4.800
	25	20	7,9	HD-20	63515 NIEUW	200	SKV	4.800

* Alle schroeven met HECO-Drive zijn 100% compatibel met conventionele TX-bits.
Het GripFit-effect is alleen gegarandeerd bij gebruik met bijpassende HECO-Drive-bits.



Uitvoering: platverzonken kop met freesholtes

Aandrijving: HECO-Drive *

Draadtype: deeldraad

Materiaal: koolstofstaal

Oppervlakte: verzinkt blauw, A3K **CHROME (VI) FREE +**

Kleurcode op het HECO-etiket

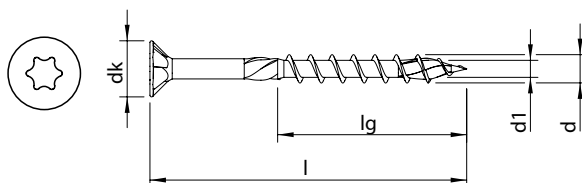

Afmeting d x l [mm]	Draadlengte lg [mm]	Kopdiameter dk [mm]	Aandrijving	ETA	Artikelnummer	Aantal per verpakking [st.]	Type verpakking	Aantal per omverpakking [st.]
3,0 ★	30	18	5,9	T-10	60123	1.000	VARIANTA	10.000
	35	21	5,9	T-10	60144	1.000	VARIANTA	10.000
	40	24	5,9	T-10	60158	500	VARIANTA	5.000
	45	27	5,9	T-10	63518	200	SKV	4.000
	45	27	5,9	T-10	60169	500	VARIANTA	5.000
3,5 ★	25	15	7,3	HD-20	60236	1.000	VARIANTA	10.000
	30	18	7,3	HD-20	60261	1.000	VARIANTA	10.000
	35	21	7,3	HD-20	60284	1.000	VARIANTA	10.000
	40	24	7,3	HD-20	60309	500	VARIANTA	5.000
	45	27	7,3	HD-20	60326	500	VARIANTA	5.000
	50	30	7,3	HD-20	60343	500	VARIANTA	5.000
4,0 ★	30	18	7,9	HD-20	60434	1.000	VARIANTA	10.000
	35	21	7,9	HD-20	60458	500	VARIANTA	5.000
	40	24	7,9	HD-20	60485	500	VARIANTA	5.000
	45	27	7,9	HD-20	60509	500	VARIANTA	5.000
	50	30	7,9	HD-20	60534	500	VARIANTA	5.000
	55	33	7,9	HD-20	60551	200	VARIANTA	2.000
	60	36	7,9	HD-20	60560	200	VARIANTA	2.000
	70	42	7,9	HD-20	60574	200	VARIANTA	2.000
4,5 ★	30	18	8,9	HD-20	60640	500	VARIANTA	5.000
	35	21	8,9	HD-20	60661	500	VARIANTA	5.000
	40	24	8,9	HD-20	62688	200	SKV	4.000
	40	24	8,9	HD-20/HD-25**	60685/62245**	500	VARIANTA	5.000
	45	27	8,9	HD-20	62689	200	SKV	4.000
	45	27	8,9	HD-20/HD-25**	60708/62246**	500	VARIANTA	5.000
	50	30	8,9	HD-20/HD-25**	60731/62247**	200	VARIANTA	2.000
	60	36	8,9	HD-20/HD-25**	60759/62248**	200	VARIANTA	2.000
	70	42	8,9	HD-20	62690	100	VARIANTA	1.000
	70	42	8,9	HD-20/HD-25**	60776/62249**	200	VARIANTA	2.000
	80	48	8,9	HD-20/HD-25**	60786/62250**	200	VARIANTA	2.000

* Alle schroeven met HECO-Drive zijn 100% compatibel met conventionele TX-bits.
Het GripFit-effect is alleen gegarandeerd bij gebruik met bijpassende HECO-Drive-bits.

** Alternatieve variant met aandrijving HD-25

Uitvoering: platverzonken kop met freesholtes

Aandrijving: HECO-Drive*

Draadtype: deeldraad

Materiaal: koolstofstaal

Oppervlakte: verzinkt blauw, A3K **CHROME (VI) FREE +**

Kleurcode op het HECO-etiket

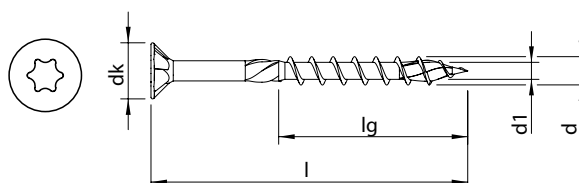

Afmeting d x l [mm]	Draadlengte lg [mm]	Kopdiameter dk [mm]	Aandrijving	ETA	Artikelnummer	Aantal per verpakking [st.]	Type verpakking	Aantal per omverpakking [st.]	
5,0	30	18	9,6	HD-20		60839	500	VARIANTA	5.000
	35	21	9,6	HD-20	●	60857	500	VARIANTA	5.000
	40	24	9,6	HD-20/HD-25**	●	60875 / 62251**	500	VARIANTA	5.000
		45	27	HD-20/HD-25**	●	60891 / 62252**	200	VARIANTA	2.000
		50	30	HD-20/HD-25**	●	60905 / 62253**	200	VARIANTA	2.000
		60	36	HD-20/HD-25**	●	60929 / 62254**	200	VARIANTA	2.000
		70	42	HD-20	●	62692	100	VARIANTA	1.000
		70	42	HD-20/HD-25**	●	60945 / 62255**	200	VARIANTA	2.000
		80	48	HD-20	●	62693	100	VARIANTA	1.000
		80	48	HD-20/HD-25**	●	60957 / 62256**	200	VARIANTA	2.000
		90	54	HD-20	●	62694	100	VARIANTA	1.000
		90	54	HD-20/HD-25**	●	60967 / 62257**	200	VARIANTA	2.000
		100	60	HD-20/HD-25**	●	60978 / 62258**	100	VARIANTA	1.000
	120	60	HD-20/HD-25**	●	60988 / 62259**	100	VARIANTA	1.000	
6,0	50	30	11,7	HD-30	●	61033	200	VARIANTA	2.000
	60	36	11,7	HD-30/HD-25**	●	61056 / 62260**	200	VARIANTA	2.000
	70	42	11,7	HD-30/HD-25**	●	61076 / 62261**	200	VARIANTA	1.000
		80	48	HD-30/HD-25**	●	61088 / 62262**	100	VARIANTA	1.000
		90	54	HD-30/HD-25**	●	61102 / 62263**	100	VARIANTA	1.000
		100	60	HD-30/HD-25**	●	61111 / 62264**	100	VARIANTA	1.000
		110	66	HD-30/HD-25**	●	61124 / 62265**	100	VARIANTA	1.000
		120	72	HD-30/HD-25**	●	61132 / 62266**	100	VARIANTA	1.000
		130	72	HD-30/HD-25**	●	61142 / 62267**	100	VARIANTA	1.000
		140	72	HD-30/HD-25**	●	61147 / 62268**	100	VARIANTA	500
		150	72	HD-30/HD-25**	●	61156 / 62269**	100	O-BOX	800
		160	72	HD-30/HD-25**	●	61163 / 62270**	100	O-BOX	800
		180	72	HD-30/HD-25**	●	61172 / 62271**	100	O-BOX	400
		200	72	HD-30/HD-25**	●	61180 / 62272**	100	O-BOX	400
		220	72	HD-30/HD-25**	●	61187 / 62273**	100	O-BOX	400
	240	72	HD-30/HD-25**	●	61195 / 62274**	100	O-BOX	400	
	260	72	HD-30/HD-25**	●	61202 / 62275**	100	O-BOX	400	
	280	72	HD-30/HD-25**	●	61209 / 62276**	100	O-BOX	400	
	300	72	HD-30/HD-25**	●	61217 / 62277**	100	O-BOX	400	

* Alle schroeven met HECO-Drive zijn 100% compatibel met conventionele TX-bits.
 Het GripFit-effect is alleen gegarandeerd bij gebruik met bijpassende HECO-Drive-bits.
 ** Alternatieve variant met aandrijving HD-25



Uitvoering: platverzonken kop met freesholtes

Aandrijving: HECO-Drive *

Draadtype: deeldraad

Materiaal: koolstofstaal

Oppervlakte: verzinkt geel, A3L **CHROME (VI) FREE +**

Kleurcode op het HECO-etiket

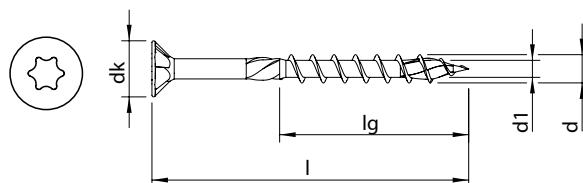

Afmeting d x l [mm]	Draadlengte lg [mm]	Kopdiameter dk [mm]	Aandrijving	ETA	Artikelnummer	Aantal per verpakking [st.]	Type verpakking	Aantal per omverpakking [st.]	
3,5 ★	25	15	7,3	HD-20	●	60238	1.000	VARIANTA	10.000
	30	18	7,3	HD-20	●	60262	1.000	VARIANTA	10.000
	35	21	7,3	HD-20	●	60286	1.000	VARIANTA	10.000
	40	24	7,3	HD-20	●	60310	500	VARIANTA	5.000
	45	27	7,3	HD-20	●	60327	500	VARIANTA	5.000
	50	30	7,3	HD-20	●	60344	500	VARIANTA	5.000
4,0 ★	30	18	7,9	HD-20	●	60436	1.000	VARIANTA	10.000
	35	21	7,9	HD-20	●	60460	500	VARIANTA	5.000
	40	24	7,9	HD-20	●	60488	500	VARIANTA	5.000
	45	27	7,9	HD-20	●	60511	500	VARIANTA	5.000
	50	30	7,9	HD-20	●	60537	500	VARIANTA	5.000
	60	36	7,9	HD-20	●	60562	200	VARIANTA	2.000
	70	42	7,9	HD-20	●	60576	200	VARIANTA	2.000
4,5 ★	30	18	8,9	HD-20	●	60641	500	VARIANTA	5.000
	35	21	8,9	HD-20	●	60662	500	VARIANTA	5.000
	40	24	8,9	HD-20	●	60686	500	VARIANTA	5.000
	45	27	8,9	HD-20	●	60709	500	VARIANTA	5.000
	50	30	8,9	HD-20	●	60733	200	VARIANTA	2.000
	60	36	8,9	HD-20	●	60761	200	VARIANTA	2.000
	70	42	8,9	HD-20	●	60778	200	VARIANTA	2.000
	80	48	8,9	HD-20	●	60788	200	VARIANTA	2.000

* Alle schroeven met HECO-Drive zijn 100% compatibel met conventionele TX-bits.
Het GripFit-effect is alleen gegarandeerd bij gebruik met bijpassende HECO-Drive-bits.

Uitvoering: platverzonken kop met freesholtes

Aandrijving: HECO-Drive*

Draadtype: deeldraad

Materiaal: koolstofstaal

Oppervlakte: verzinkt geel, A3L **CHROME (VI) FREE +**

Kleurcode op het HECO-etiket

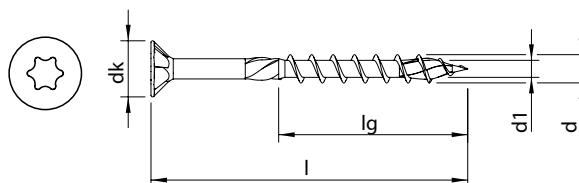

Afmeting d x l [mm]	Draadlengte lg [mm]	Kopdiameter dk [mm]	Aandrijving	ETA	Artikelnummer	Aantal per verpakking [st.]	Type verpakking	Aantal per omverpakking [st.]
5,0 	30	18	9,6	HD-20	60840	500	VARIANTA	5.000
	35	21	9,6	HD-20	60858	500	VARIANTA	5.000
	40	24	9,6	HD-20	60877	500	VARIANTA	2.500
	45	27	9,6	HD-20	60892	200	VARIANTA	2.000
	50	30	9,6	HD-20	60907	200	VARIANTA	2.000
	60	36	9,6	HD-20	60931	200	VARIANTA	2.000
	70	42	9,6	HD-20	60947	200	VARIANTA	2.000
	80	48	9,6	HD-20	60959	200	VARIANTA	2.000
	90	54	9,6	HD-20	60969	200	VARIANTA	2.000
	100	60	9,6	HD-20	60980	100	VARIANTA	1.000
	120	60	9,6	HD-20	60990	100	VARIANTA	1.000
	6,0 	50	30	11,7	HD-30	61034	200	VARIANTA
60		36	11,7	HD-30	61058	200	VARIANTA	2.000
70		42	11,7	HD-30	61078	200	VARIANTA	1.000
80		48	11,7	HD-30	61090	100	VARIANTA	1.000
90		54	11,7	HD-30	61104	100	VARIANTA	1.000
100		60	11,7	HD-30	61113	100	VARIANTA	1.000
110		66	11,7	HD-30	61126	100	VARIANTA	1.000
120		72	11,7	HD-30	61134	100	VARIANTA	1.000

* Alle schroeven met HECO-Drive zijn 100% compatibel met conventionele TX-bits.
Het GripFit-effect is alleen gegarandeerd bij gebruik met bijpassende HECO-Drive-bits.



Uitvoering: platverzonken kop met freesholtes

Aandrijving: HECO-Drive *

Draadtype: deeldraad

Materiaal: roestvaststaal A2 1.4567

Oppervlakte: blank, glijcoating

Kleurcode op het HECO-etiket

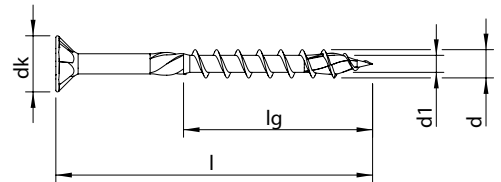

Afmeting d x l [mm]	Draadlengte lg [mm]	Kopdiameter dk [mm]	Aandrijving	ETA	Artikelnummer	Aantal per verpakking [st.]	Type verpakking	Aantal per omverpakking [st.]	
3,5 ★	30	18	7,3	HD-20	●	61637	200	SKV	4.800
	35	21	7,3	HD-20	●	61642	200	SKV	4.000
	40	24	7,3	HD-20	●	61647	200	SKV	4.000
	45	27	7,3	HD-20	●	61650	200	SKV	4.000
	50	30	7,3	HD-20	●	61653	200	SKV	4.000
4,0 ★	25	15	7,9	HD-20	●	61662	200	SKV	4.800
	30	18	7,9	HD-20	●	61667	200	SKV	4.800
	35	21	7,9	HD-20	●	61672	200	SKV	4.000
	40	24	7,9	HD-20	●	61677	200	SKV	4.000
	45	27	7,9	HD-20	●	61681	200	SKV	4.000
	50	30	7,9	HD-20	●	61685	200	SKV	4.000
	60	36	7,9	HD-20	●	61689	200	VARIANTA	2.000
70	42	7,9	HD-20	●	61690	200	VARIANTA	2.000	
4,5 ★ ★	30	18	8,9	HD-20	●	61694	200	SKV	4.000
	35	21	8,9	HD-20/HD-25**	●	61696/62470**	200	SKV	4.000
	40	24	8,9	HD-20/HD-25**	●	61699/62471**	200	SKV	4.000
	45	27	8,9	HD-20/HD-25**	●	61703/62472**	200	SKV	4.000
	50	30	8,9	HD-20/HD-25**	●	61709/62473**	200	VARIANTA	2.000
	60	36	8,9	HD-20/HD-25**	●	61714/62474**	200	VARIANTA	2.000
	70	42	8,9	HD-20/HD-25**	●	61718/62475**	200	VARIANTA	2.000
	80	48	8,9	HD-20/HD-25**	●	61722/62476**	200	VARIANTA	2.000

* Alle schroeven met HECO-Drive zijn 100% compatibel met conventionele TX-bits.
 Het GripFit-effect is alleen gegarandeerd bij gebruik met bijpassende HECO-Drive-bits.
 ** Alternatieve variant met aandrijving HD-25

Uitvoering: platverzonken kop met freesholtes

Aandrijving: HECO-Drive*

Draadtype: deeldraad

Materiaal: roestvaststaal A2 1.4567

Oppervlakte: blank, glijcoating

Kleurcode op het HECO-etiket

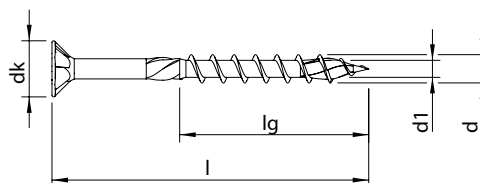

Afmeting d x l [mm]	Draadlengte lg [mm]	Kopdiameter dk [mm]	Aandrijving	ETA	Artikelnummer	Aantal per verpakking [st.]	Type verpakking	Aantal per omverpakking [st.]
5,0	30	18	9,6	HD-20	61731	200	SKV	4.000
	35	21	9,6	HD-20/HD-25**	61736/62477**	200	SKV	4.000
	40	24	9,6	HD-20/HD-25**	61746/62478**	200	SKV	4.000
	45	27	9,6	HD-20/HD-25**	61752/62479**	200	VARIANTA	2.000
	50	30	9,6	HD-20/HD-25**	61762/62480**	200	VARIANTA	2.000
	60	36	9,6	HD-20/HD-25**	61775/62481**	200	VARIANTA	2.000
	70	42	9,6	HD-20/HD-25**	61786/62482**	200	VARIANTA	2.000
	80	48	9,6	HD-20/HD-25**	61796/62483**	200	VARIANTA	2.000
	90	54	9,6	HD-20/HD-25**	61797/62484**	200	VARIANTA	2.000
	100	60	9,6	HD-20/HD-25**	61798/62485**	100	VARIANTA	1.000
6,0	40	24	11,7	HD-30	61801	200	VARIANTA	2.000
	50	30	11,7	HD-30/HD-25**	61804/62486**	200	VARIANTA	2.000
	60	36	11,7	HD-30/HD-25**	61808/62487**	200	VARIANTA	2.000
	70	42	11,7	HD-30/HD-25**	61813/62488**	200	VARIANTA	1.000
	80	48	11,7	HD-30/HD-25**	61818/62489**	100	VARIANTA	1.000
	90	54	11,7	HD-30/HD-25**	61822/62490**	100	VARIANTA	1.000
	100	60	11,7	HD-30/HD-25**	61826/62492**	100	VARIANTA	1.000
	120	72	11,7	HD-30/HD-25**	61833/62493**	100	VARIANTA	1.000
	140	72	11,7	HD-30/HD-25**	61838/62494**	100	VARIANTA	500
	160	72	11,7	HD-30/HD-25**	61840/62495**	100	O-BOX	400
180	72	11,7	HD-30	61842	100	O-BOX	400	
200	72	11,7	HD-30	61843	100	O-BOX	400	

* Alle schroeven met HECO-Drive zijn 100% compatibel met conventionele TX-bits.
 Het GripFit-effect is alleen gegarandeerd bij gebruik met bijpassende HECO-Drive-bits.

** Alternatieve variant met aandrijving HD-25



Uitvoering: platverzonken kop met freesholtes

Aandrijving: HECO-Drive *

Draadtype: deeldraad

Materiaal: koolstofstaal

Oppervlakte: verzinkt zwart, A3T **CHROME (VI) FREE +**

Kleurcode op het HECO-etiket

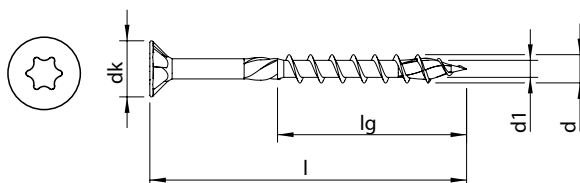

Afmeting d x l [mm]	Draadlengte lg [mm]	Kopdiameter dk [mm]	Aandrijving	ETA	Artikelnummer	Aantal per verpakking [st.]	Type verpakking	Aantal per omverpakking [st.]
4,0**	40	24	7,9	HD-20	● 63516 NIEUW	200	SKV	4.000
4,5**	40	24	8,9	HD-20	● 63517 NIEUW	200	SKV	4.000

* Alle schroeven met HECO-Drive zijn 100% compatibel met conventionele TX-bits.
Het GripFit-effect is alleen gegarandeerd bij gebruik met bijpassende HECO-Drive-bits.

** Kleurcode HD bit = ●



Uitvoering: platverzonken kop met freesholtes

Aandrijving: Pozi-Drive

Draadtype: variabele voldraad

Materiaal: koolstofstaal

Oppervlakte: verzinkt blauw, A3K **CHROME (VI) FREE +**

Kleurcode op het HECO-etiket

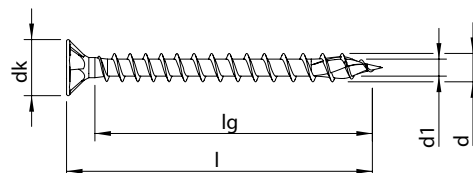

Afmeting d x l [mm]	Draadlengte lg [mm]	Kopdiameter dk [mm]	Aandrijving	ETA	Artikelnummer	Aantal per verpakking [st.]	Type verpakking	Aantal per omverpakking [st.]
2,5 +	10	7	4,9	PZD-1	60001	200	SKV	4.800
	10	7	4,9	PZD-1	60002	1.000	VARIANTA	10.000
	12	9	4,9	PZD-1	60005	200	SKV	4.800
	12	9	4,9	PZD-1	60006	1.000	VARIANTA	10.000
	16	13	4,9	PZD-1	60015	200	SKV	4.800
	16	13	4,9	PZD-1	60016	1.000	VARIANTA	10.000
	20	17	4,9	PZD-1	60022	200	SKV	4.800
	20	17	4,9	PZD-1	60023	1.000	VARIANTA	10.000
	25	22	4,9	PZD-1	60026	200	SKV	4.800
	25	22	4,9	PZD-1	60027	1.000	VARIANTA	10.000
3,0 +	10	6	5,9	PZD-1	60030	200	SKV	4.800
	10	6	5,9	PZD-1	60031	1.000	VARIANTA	10.000
	12	8	5,9	PZD-1	60035	200	SKV	4.800
	12	8	5,9	PZD-1	60036	1.000	VARIANTA	10.000
	15	11	5,9	PZD-1	60050	200	SKV	4.800
	15	11	5,9	PZD-1	60051	1.000	VARIANTA	10.000
	16	12	5,9	PZD-1	60057	200	SKV	4.800
	16	12	5,9	PZD-1	60058	1.000	VARIANTA	10.000
	20	16	5,9	PZD-1	60077	200	SKV	4.800
	20	16	5,9	PZD-1	60078	1.000	VARIANTA	10.000
	25	21	5,9	PZD-1	60095	200	SKV	4.800
	25	21	5,9	PZD-1	60096	1.000	VARIANTA	10.000
	30	26	5,9	PZD-1	60112	200	SKV	4.800
	30	26	5,9	PZD-1	60113	1.000	VARIANTA	10.000
	35	31	5,9	PZD-1	60134	200	SKV	4.800
	35	31	5,9	PZD-1	60135	1.000	VARIANTA	10.000
40	36	5,9	PZD-1	60147	200	SKV	4.000	
40	36	5,9	PZD-1	60148	500	VARIANTA	5.000	
45	41	5,9	PZD-1	60160	500	VARIANTA	5.000	

Uitvoering: platverzonken kop met freesholtes

Aandrijving: Pozi-Drive

Draadtype: variabele voldraad

Materiaal: koolstofstaal

Oppervlakte: verzinkt blauw, A3K **CHROME (VI) FREE +**

Kleurcode op het HECO-etiket

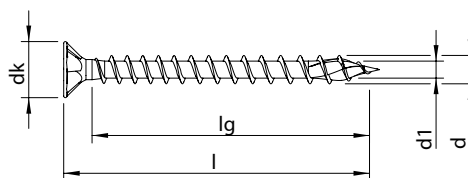

Afmeting d x l [mm]	Draadlengte lg [mm]	Kopdiameter dk [mm]	Aandrijving	ETA	Artikelnummer	Aantal per verpakking [st.]	Type verpakking	Aantal per omverpakking [st.]
3,5 	12	7	7,3	PZD-2	60171	200	SKV	4.800
	12	7	7,3	PZD-2	60172	1.000	VARIANTA	10.000
	15	10	7,3	PZD-2	60183	200	SKV	4.800
	15	10	7,3	PZD-2	60184	1.000	VARIANTA	10.000
	16	11	7,3	PZD-2	60190	200	SKV	4.800
	16	11	7,3	PZD-2	60191	1.000	VARIANTA	10.000
	20	15	7,3	PZD-2	• 60209	200	SKV	4.800
	20	15	7,3	PZD-2	• 60210	1.000	VARIANTA	10.000
	25	20	7,3	PZD-2	• 60226	200	SKV	4.800
	25	20	7,3	PZD-2	• 60227	1.000	VARIANTA	10.000
	30	25	7,3	PZD-2	• 60251	200	SKV	4.800
	30	25	7,3	PZD-2	• 60252	1.000	VARIANTA	10.000
	35	30	7,3	PZD-2	• 60274	200	SKV	4.000
	35	30	7,3	PZD-2	• 60275	1.000	VARIANTA	10.000
	40	35	7,3	PZD-2	• 60298	200	SKV	4.000
	40	35	7,3	PZD-2	• 60299	500	VARIANTA	5.000
	45	40	7,3	PZD-2	• 60316	200	SKV	4.000
	45	40	7,3	PZD-2	• 60317	500	VARIANTA	5.000
50	45	7,3	PZD-2	• 60332	200	SKV	4.000	
50	45	7,3	PZD-2	• 60333	500	VARIANTA	5.000	



Uitvoering: platverzonken kop met freesholtes

Aandrijving: Pozi-Drive

Draadtype: variabele voldraad

Materiaal: koolstofstaal

Oppervlakte: verzinkt blauw, A3K **CHROME (VI) FREE +**

Kleurcode op het HECO-etiket

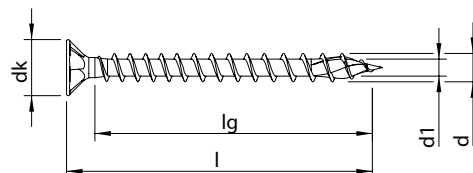

Afmeting d x l [mm]	Draadlengte lg [mm]	Kopdiameter dk [mm]	Aandrijving	ETA	Artikelnummer	Aantal per verpakking [st.]	Type verpakking	Aantal per omverpakking [st.]
4,0 	12	7	7,9	PZD-2	60350	200	SKV	4.800
	12	7	7,9	PZD-2	60351	1.000	VARIANTA	10.000
	15	10	7,9	PZD-2	60361	200	SKV	4.800
	15	10	7,9	PZD-2	60362	1.000	VARIANTA	10.000
	16	11	7,9	PZD-2	60368	200	SKV	4.800
	16	11	7,9	PZD-2	60369	1.000	VARIANTA	10.000
	20	15	7,9	PZD-2	60384	200	SKV	4.800
	20	15	7,9	PZD-2	60385	1.000	VARIANTA	10.000
	25	20	7,9	PZD-2	• 60400	200	SKV	4.800
	25	20	7,9	PZD-2	• 60401	1.000	VARIANTA	10.000
	30	25	7,9	PZD-2	• 60424	200	SKV	4.800
	30	25	7,9	PZD-2	• 60425	1.000	VARIANTA	10.000
	35	30	7,9	PZD-2	• 60448	200	SKV	4.000
	35	30	7,9	PZD-2	• 60449	500	VARIANTA	5.000
	40	35	7,9	PZD-2	• 60469	200	SKV	4.000
	40	35	7,9	PZD-2	• 60471	500	VARIANTA	5.000
	40	35	7,9	PZD-2	• 60472	1.000	VARIANTA	10.000
	45	40	7,9	PZD-2	• 60497	200	SKV	4.000
	45	40	7,9	PZD-2	• 60498	500	VARIANTA	5.000
	50	45	7,9	PZD-2	• 60520	200	SKV	4.000
50	45	7,9	PZD-2	• 60521	500	VARIANTA	5.000	
55	50	7,9	PZD-2	• 60545	200	VARIANTA	2.000	
60	55	7,9	PZD-2	• 60554	200	VARIANTA	2.000	
70	65	7,9	PZD-2	• 60567	200	VARIANTA	2.000	

Uitvoering: platverzonken kop met freesholtes

Aandrijving: Pozi-Drive

Draadtype: variabele voldraad

Materiaal: koolstofstaal

Oppervlakte: verzinkt blauw, A3K **CHROME (VI) FREE +**

Kleurcode op het HECO-etiket

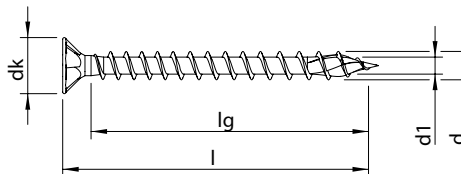
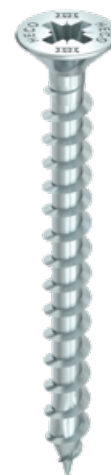

Afmeting d x l [mm]	Draadlengte lg [mm]	Kopdiameter dk [mm]	Aandrijving	ETA	Artikelnummer	Aantal per verpakking [st.]	Type verpakking	Aantal per omverpakking [st.]
4,5 	16	11	8,9	PZD-2	60581	200	SKV	4.800
	16	11	8,9	PZD-2	60582	1.000	VARIANTA	10.000
	20	15	8,9	PZD-2	60593	200	SKV	4.800
	20	15	8,9	PZD-2	60594	1.000	VARIANTA	10.000
	25	20	8,9	PZD-2	• 60611	200	SKV	4.800
	25	20	8,9	PZD-2	• 60612	500	VARIANTA	5.000
	30	25	8,9	PZD-2	• 60629	200	SKV	4.000
	30	25	8,9	PZD-2	• 60630	500	VARIANTA	5.000
	35	30	8,9	PZD-2	• 60651	200	SKV	4.000
	35	30	8,9	PZD-2	• 60652	500	VARIANTA	5.000
	40	35	8,9	PZD-2	• 60674	200	SKV	4.000
	40	35	8,9	PZD-2	• 60675	500	VARIANTA	5.000
	45	40	8,9	PZD-2	• 60698	200	SKV	4.000
	45	40	8,9	PZD-2	• 60699	500	VARIANTA	5.000
	50	45	8,9	PZD-2	• 60723	200	VARIANTA	2.000
	55	50	8,9	PZD-2	• 60740	200	VARIANTA	2.000
	60	55	8,9	PZD-2	• 60753	200	VARIANTA	2.000
70	65	8,9	PZD-2	• 60770	200	VARIANTA	2.000	
80	75	8,9	PZD-2	• 60782	200	VARIANTA	2.000	



Uitvoering: platverzonken kop met freesholtes

Aandrijving: Pozi-Drive

Draadtype: variabele voldraad

Materiaal: koolstofstaal

Oppervlakte: verzinkt blauw, A3K **CHROME (VI) FREE +**

Kleurcode op het HECO-etiket

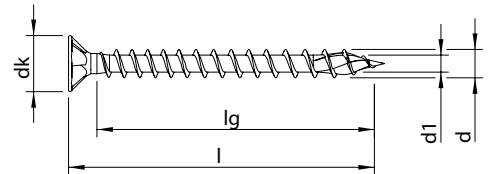

Afmeting d x l [mm]	Draadlengte lg [mm]	Kopdiameter dk [mm]	Aandrijving	ETA	Artikelnummer	Aantal per verpakking [st.]	Type verpakking	Aantal per omverpakking [st.]
5,0 +	20	14	9,6	PZD-2	60802	200	SKV	4.800
	20	14	9,6	PZD-2	60803	500	VARIANTA	5.000
	25	19	9,6	PZD-2	60814	200	SKV	4.000
	25	19	9,6	PZD-2	60815	500	VARIANTA	5.000
	30	24	9,6	PZD-2	• 60828	200	SKV	4.000
	30	24	9,6	PZD-2	• 60829	500	VARIANTA	5.000
	35	29	9,6	PZD-2	• 60846	200	SKV	4.000
	35	29	9,6	PZD-2	• 60847	500	VARIANTA	5.000
	40	34	9,6	PZD-2	• 60865	200	SKV	4.000
	40	34	9,6	PZD-2	• 60866	500	VARIANTA	5.000
	45	39	9,6	PZD-2	• 60885	200	VARIANTA	2.000
	50	44	9,6	PZD-2	• 60898	200	VARIANTA	2.000
	55	49	9,6	PZD-2	• 60912	200	VARIANTA	2.000
	60	54	9,6	PZD-2	• 60922	200	VARIANTA	2.000
	70	64	9,6	PZD-2	• 60938	200	VARIANTA	2.000
	80	74	9,6	PZD-2	• 60952	200	VARIANTA	2.000
90	84	9,6	PZD-2	• 60963	200	VARIANTA	2.000	
100	94	9,6	PZD-2	• 60971	100	VARIANTA	1.000	
120	114	9,6	PZD-2	• 60983	100	VARIANTA	1.000	
6,0 +	30	23	11,7	PZD-3	60994	200	VARIANTA	2.000
	35	28	11,7	PZD-3	• 61000	200	VARIANTA	2.000
	40	33	11,7	PZD-3	• 61004	200	VARIANTA	2.000
	45	38	11,7	PZD-3	• 61018	200	VARIANTA	2.000
	50	43	11,7	PZD-3	• 61026	200	VARIANTA	2.000
	60	53	11,7	PZD-3	• 61049	200	VARIANTA	2.000
	70	63	11,7	PZD-3	• 61070	200	VARIANTA	2.000
	80	73	11,7	PZD-3	• 61083	100	VARIANTA	1.000
	90	83	11,7	PZD-3	• 61097	100	VARIANTA	1.000
	100	93	11,7	PZD-3	• 61106	100	VARIANTA	1.000
	110	103	11,7	PZD-3	• 61120	100	VARIANTA	1.000
	120	113	11,7	PZD-3	• 61127	100	VARIANTA	1.000

Uitvoering: platverzonken kop met freesholtes

Aandrijving: Pozi-Drive

Draadtype: variabele voldraad

Materiaal: koolstofstaal

Oppervlakte: verzinkt geel, A3L **CHROME (VI) FREE +**

Kleurcode op het HECO-etiket

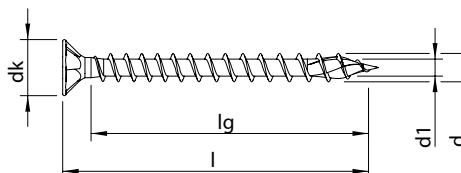
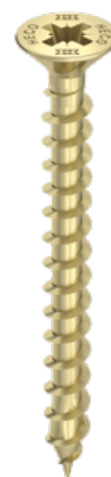

Afmeting d x l [mm]	Draadlengte lg [mm]	Kopdiameter dk [mm]	Aandrijving	ETA	Artikelnummer	Aantal per verpakking [st.]	Type verpakking	Aantal per omverpakking [st.]
2,5 +	16	13	4,9	PZD-1	60017	1.000	VARIANTA	10.000
	20	17	4,9	PZD-1	60025	1.000	VARIANTA	10.000
	25	22	4,9	PZD-1	60029	1.000	VARIANTA	10.000
3,0 +	16	12	5,9	PZD-1	60060	1.000	VARIANTA	10.000
	20	16	5,9	PZD-1	60080	1.000	VARIANTA	10.000
	25	21	5,9	PZD-1	60098	1.000	VARIANTA	10.000
	30	26	5,9	PZD-1	60115	1.000	VARIANTA	10.000
	35	31	5,9	PZD-1	60137	1.000	VARIANTA	10.000
	40	36	5,9	PZD-1	60150	500	VARIANTA	5.000
3,5 +	16	11	7,3	PZD-2	60193	1.000	VARIANTA	10.000
	20	15	7,3	PZD-2	60212	1.000	VARIANTA	10.000
	25	20	7,3	PZD-2	60229	1.000	VARIANTA	10.000
	30	25	7,3	PZD-2	60254	1.000	VARIANTA	10.000
	35	30	7,3	PZD-2	60277	1.000	VARIANTA	10.000
	40	35	7,3	PZD-2	60301	500	VARIANTA	5.000
	45	40	7,3	PZD-2	60319	500	VARIANTA	5.000
	50	45	7,3	PZD-2	60335	500	VARIANTA	5.000
4,0 +	16	11	7,9	PZD-2	60371	1.000	VARIANTA	10.000
	20	15	7,9	PZD-2	60388	1.000	VARIANTA	10.000
	25	20	7,9	PZD-2	60404	1.000	VARIANTA	10.000
	30	25	7,9	PZD-2	60427	1.000	VARIANTA	10.000
	35	30	7,9	PZD-2	60451	500	VARIANTA	5.000
	40	35	7,9	PZD-2	60474	500	VARIANTA	5.000
	45	40	7,9	PZD-2	60500	500	VARIANTA	5.000
	50	45	7,9	PZD-2	60524	500	VARIANTA	5.000
	60	55	7,9	PZD-2	60555	200	VARIANTA	2.000
	70	65	7,9	PZD-2	60569	200	VARIANTA	2.000



Uitvoering: platverzonken kop met freesholtes

Aandrijving: Pozi-Drive

Draadtype: variabele voldraad

Materiaal: koolstofstaal

Oppervlakte: verzinkt geel, A3L **CHROME (VI) FREE +**

Kleurcode op het HECO-etiket

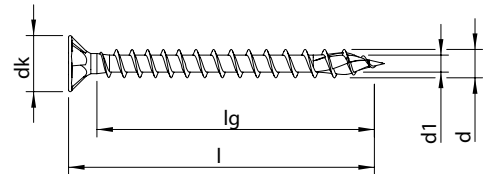

Afmeting d x l [mm]	Draadlengte lg [mm]	Kopdiameter dk [mm]	Aandrijving	ETA	Artikelnummer	Aantal per verpakking [st.]	Type verpakking	Aantal per omverpakking [st.]
4,5 +	16	11	8,9	PZD-2	60584	1.000	VARIANTA	10.000
	20	15	8,9	PZD-2	60597	1.000	VARIANTA	10.000
	25	20	8,9	PZD-2	• 60615	500	VARIANTA	5.000
	30	25	8,9	PZD-2	• 60632	500	VARIANTA	5.000
	35	30	8,9	PZD-2	• 60654	500	VARIANTA	5.000
	40	35	8,9	PZD-2	• 60677	500	VARIANTA	5.000
	45	40	8,9	PZD-2	• 60701	500	VARIANTA	5.000
	50	45	8,9	PZD-2	• 60724	200	VARIANTA	2.000
	60	55	8,9	PZD-2	• 60754	200	VARIANTA	2.000
	70	65	8,9	PZD-2	• 60771	200	VARIANTA	2.000
5,0 +	20	14	9,6	PZD-2	60805	500	VARIANTA	5.000
	25	19	9,6	PZD-2	60817	500	VARIANTA	5.000
	30	24	9,6	PZD-2	• 60831	500	VARIANTA	5.000
	35	29	9,6	PZD-2	• 60850	500	VARIANTA	5.000
	40	34	9,6	PZD-2	• 60868	500	VARIANTA	5.000
	45	39	9,6	PZD-2	• 60886	200	VARIANTA	2.000
	50	44	9,6	PZD-2	• 60899	200	VARIANTA	2.000
	60	54	9,6	PZD-2	• 60923	200	VARIANTA	2.000
6,0 +	30	23	11,7	PZD-3	60995	200	VARIANTA	2.000
	35	28	11,7	PZD-3	• 61001	200	VARIANTA	2.000
	40	33	11,7	PZD-3	• 61005	200	VARIANTA	2.000
	45	38	11,7	PZD-3	• 61019	200	VARIANTA	2.000
	50	43	11,7	PZD-3	• 61027	200	VARIANTA	2.000
	60	53	11,7	PZD-3	• 61050	200	VARIANTA	2.000
	70	63	11,7	PZD-3	• 61071	200	VARIANTA	2.000

Uitvoering: platverzonken kop met freesholtes

Aandrijving: Pozi-Drive

Draadtype: variabele voldraad

Materiaal: roestvaststaal A2 1.4567

Oppervlakte: blank, glijcoating

Kleurcode op het HECO-etiket

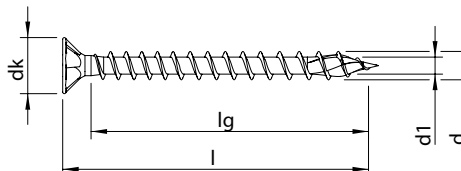

Afmeting d x l [mm]	Draadlengte lg [mm]	Kopdiameter dk [mm]	Aandrijving	ETA	Artikelnummer	Aantal per verpakking [st.]	Type verpakking	Aantal per omverpakking [st.]
3,0 +	20	16	5,9	PZD-1	61617	200	SKV	4.800
	25	21	5,9	PZD-1	61622	200	SKV	4.800
	30	26	5,9	PZD-1	61624	200	SKV	4.800
	35	31	5,9	PZD-1	61628	200	SKV	4.800
3,5 +	16	12	7,3	PZD-2	61630	200	SKV	4.800
	20	16	7,3	PZD-2	61631	200	SKV	4.800
	25	21	7,3	PZD-2	61634	200	SKV	4.800
	30	26	7,3	PZD-2	61636	200	SKV	4.800
	35	31	7,3	PZD-2	61640	200	SKV	4.000
	40	36	7,3	PZD-2	61646	200	SKV	4.000
4,0 +	20	15	7,9	PZD-2	61656	200	SKV	4.800
	25	20	7,9	PZD-2	61661	200	SKV	4.800
	30	25	7,9	PZD-2	61665	200	SKV	4.800
	35	30	7,9	PZD-2	61671	200	SKV	4.000
	40	35	7,9	PZD-2	61676	200	SKV	4.000
	45	40	7,9	PZD-2	61680	200	SKV	4.000
	50	45	7,9	PZD-2	61684	200	SKV	4.000
	60	55	7,9	PZD-2	61688	200	VARIANTA	2.000
4,5 +	25	20	8,9	PZD-2	61691	200	SKV	4.800
	30	25	8,9	PZD-2	61693	200	SKV	4.000
	35	30	8,9	PZD-2	61695	200	SKV	4.000
	40	35	8,9	PZD-2	61697	200	SKV	4.000
	45	40	8,9	PZD-2	61702	200	SKV	4.000
	50	45	8,9	PZD-2	61708	200	VARIANTA	2.000
	60	55	8,9	PZD-2	61713	200	VARIANTA	2.000



Uitvoering: platverzonken kop met freesholtes

Aandrijving: Pozi-Drive

Draadtype: variabele voldraad

Materiaal: roestvaststaal A2 1.4567

Oppervlakte: blank, glijcoating

Kleurcode op het HECO-etiket

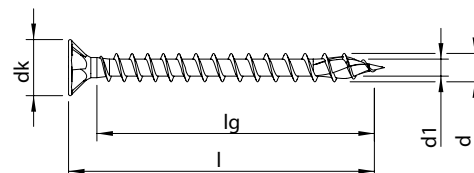

Afmeting d x l [mm]	Draadlengte lg [mm]	Kopdiameter dk [mm]	Aandrijving	ETA	Artikelnummer	Aantal per verpakking [st.]	Type verpakking	Aantal per omverpakking [st.]
5,0 +	25	19	9,6	PZD-2	61727	200	SKV	4.000
	30	24	9,6	PZD-2	61730	200	SKV	4.000
	35	29	9,6	PZD-2	61735	200	SKV	4.000
	40	34	9,6	PZD-2	61745	200	SKV	4.000
	45	39	9,6	PZD-2	61751	200	VARIANTA	2.000
	50	44	9,6	PZD-2	61761	200	VARIANTA	2.000
	60	54	9,6	PZD-2	61774	200	VARIANTA	2.000
	70	64	9,6	PZD-2	61785	200	VARIANTA	2.000
6,0 +	80	74	9,6	PZD-2	61795	200	VARIANTA	2.000
	60	53	11,7	PZD-3	61807	200	VARIANTA	2.000
	80	73	11,7	PZD-3	61817	100	VARIANTA	1.000
	100	60	11,7	PZD-3	61825*	100	VARIANTA	1.000
	120	72	11,7	PZD-3	61832*	100	VARIANTA	1.000

* Dit artikel is een andere versie met deeldraad

Uitvoering: platverzonken kop met freesholtes

Aandrijving: Pozi-Drive

Draadtype: deeldraad

Materiaal: koolstofstaal

Oppervlakte: verzinkt blauw, A3K **CHROME (VI) FREE +**

Kleurcode op het HECO-etiket

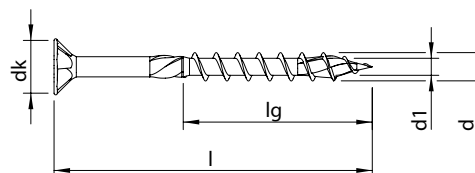

Afmeting d x l [mm]	Draadlengte lg [mm]	Kopdiameter dk [mm]	Aandrijving	ETA	Artikelnummer	Aantal per verpakking [st.]	Type verpakking	Aantal per omverpakking [st.]
3,0 +	30	18	5,9	PZD-1	60121	1.000	VARIANTA	10.000
	35	21	5,9	PZD-1	60142	1.000	VARIANTA	10.000
	40	24	5,9	PZD-1	60155	500	VARIANTA	5.000
	45	27	5,9	PZD-1	60167	500	VARIANTA	5.000
3,5 +	25	15	7,3	PZD-2	60234	1.000	VARIANTA	10.000
	30	18	7,3	PZD-2	60259	1.000	VARIANTA	10.000
	35	21	7,3	PZD-2	60282	1.000	VARIANTA	10.000
	40	24	7,3	PZD-2	60306	500	VARIANTA	5.000
	45	27	7,3	PZD-2	60324	500	VARIANTA	5.000
	50	30	7,3	PZD-2	60340	500	VARIANTA	5.000
4,0 +	30	18	7,9	PZD-2	60432	1.000	VARIANTA	10.000
	35	21	7,9	PZD-2	60456	500	VARIANTA	5.000
	40	24	7,9	PZD-2	60481	500	VARIANTA	5.000
	45	27	7,9	PZD-2	60506	500	VARIANTA	5.000
	50	30	7,9	PZD-2	60530	500	VARIANTA	5.000
	60	36	7,9	PZD-2	60558	200	VARIANTA	2.000
	70	42	7,9	PZD-2	60572	200	VARIANTA	2.000



Uitvoering: platverzonken kop met freesholtes

Aandrijving: Pozi-Drive

Draadtype: deeldraad

Materiaal: koolstofstaal

Oppervlakte: verzinkt blauw, A3K **CHROME (VI) FREE +**

Kleurcode op het HECO-etiket

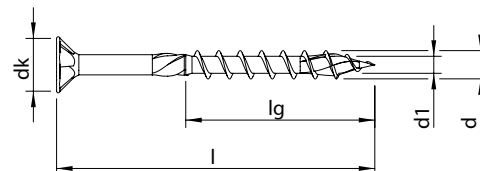

Afmeting d x l [mm]	Draadlengte lg [mm]	Kopdiameter dk [mm]	Aandrijving	ETA	Artikelnummer	Aantal per verpakking [st.]	Type verpakking	Aantal per omverpakking [st.]	
4,5 +	30	18	8,9	PZD-2	•	60638	500	VARIANTA	5.000
	35	21	8,9	PZD-2	•	60659	500	VARIANTA	5.000
	40	24	8,9	PZD-2	•	60682	500	VARIANTA	5.000
	45	27	8,9	PZD-2	•	60706	500	VARIANTA	5.000
	50	30	8,9	PZD-2	•	60729	200	VARIANTA	2.000
	60	36	8,9	PZD-2	•	60757	200	VARIANTA	2.000
	70	42	8,9	PZD-2	•	60774	200	VARIANTA	2.000
	80	48	8,9	PZD-2	•	60784	200	VARIANTA	2.000
5,0 +	30	18	9,6	PZD-2	•	60837	500	VARIANTA	5.000
	35	21	9,6	PZD-2	•	60855	500	VARIANTA	5.000
	40	24	9,6	PZD-2	•	60873	500	VARIANTA	5.000
	45	27	9,6	PZD-2	•	60889	200	VARIANTA	2.000
	50	30	9,6	PZD-2	•	60903	200	VARIANTA	2.000
	60	36	9,6	PZD-2	•	60927	200	VARIANTA	2.000
	70	42	9,6	PZD-2	•	60943	200	VARIANTA	2.000
	80	48	9,6	PZD-2	•	60955	200	VARIANTA	2.000
	90	54	9,6	PZD-2	•	60965	200	VARIANTA	2.000
	100	60	9,6	PZD-2	•	60974	100	VARIANTA	1.000
120	60	9,6	PZD-2	•	60986	100	VARIANTA	1.000	

Uitvoering: platverzonken kop met freesholtes

Aandrijving: Pozi-Drive

Draadtype: deeldraad

Materiaal: koolstofstaal

Oppervlakte: verzinkt blauw, A3K **CHROME (VI) FREE +**

Kleurcode op het HECO-etiket

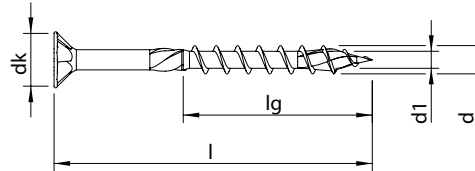

Afmeting d x l [mm]	Draadlengte lg [mm]	Kopdiameter dk [mm]	Aandrijving	ETA	Artikelnummer	Aantal per verpakking [st.]	Type verpakking	Aantal per omverpakking [st.]	
6,0 	40	24	11,7	PZD-3	•	61008	200	VARIANTA	2.000
	45	27	11,7	PZD-3	•	61022	200	VARIANTA	2.000
	50	30	11,7	PZD-3	•	61031	200	VARIANTA	2.000
	60	36	11,7	PZD-3	•	61054	200	VARIANTA	2.000
	70	42	11,7	PZD-3	•	61074	200	VARIANTA	2.000
	80	48	11,7	PZD-3	•	61086	100	VARIANTA	1.000
	90	54	11,7	PZD-3	•	61100	100	VARIANTA	1.000
	100	60	11,7	PZD-3	•	61109	100	VARIANTA	1.000
	110	66	11,7	PZD-3	•	61122	100	VARIANTA	1.000
	120	72	11,7	PZD-3	•	61130	100	VARIANTA	1.000
	130	72	11,7	PZD-3	•	61140	100	VARIANTA	1.000
	140	72	11,7	PZD-3	•	61145	100	VARIANTA	500
	150	72	11,7	PZD-3	•	61154	100	VARIANTA	800
	160	72	11,7	PZD-3	•	61161	100	VARIANTA	800
	180	72	11,7	PZD-3	•	61170	100	VARIANTA	400
200	72	11,7	PZD-3	•	61178	100	VARIANTA	400	



Uitvoering: platverzonken kop met freesholtes

Aandrijving: Pozi-Drive

Draadtype: deeldraad

Materiaal: koolstofstaal

Oppervlakte: verzinkt geel, A3L **CHROME (VI) FREE +**

Kleurcode op het HECO-etiket

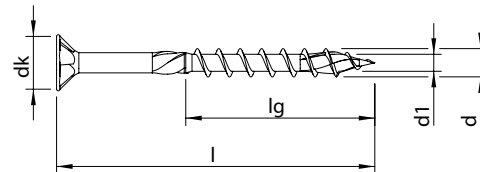

Afmeting d x l [mm]	Draadlengte lg [mm]	Kopdiameter dk [mm]	Aandrijving	ETA	Artikelnummer	Aantal per verpakking [st.]	Type verpakking	Aantal per omverpakking [st.]	
3,5 +	25	15	7,3	PZD-2	•	60235	1.000	VARIANTA	10.000
	30	18	7,3	PZD-2	•	60260	1.000	VARIANTA	10.000
	35	21	7,3	PZD-2	•	60283	1.000	VARIANTA	10.000
	40	24	7,3	PZD-2	•	60307	500	VARIANTA	5.000
	45	27	7,3	PZD-2	•	60325	500	VARIANTA	5.000
	50	30	7,3	PZD-2	•	60341	500	VARIANTA	5.000
4,0 +	30	18	7,9	PZD-2	•	60433	1.000	VARIANTA	10.000
	35	21	7,9	PZD-2	•	60457	500	VARIANTA	5.000
	40	24	7,9	PZD-2	•	60483	500	VARIANTA	5.000
	45	27	7,9	PZD-2	•	60507	500	VARIANTA	5.000
	50	30	7,9	PZD-2	•	60532	500	VARIANTA	5.000
	60	36	7,9	PZD-2	•	60559	200	VARIANTA	2.000
4,5 +	70	42	7,9	PZD-2	•	60573	200	VARIANTA	2.000
	30	18	8,9	PZD-2	•	60639	500	VARIANTA	5.000
	35	21	8,9	PZD-2	•	60660	500	VARIANTA	5.000
	40	24	8,9	PZD-2	•	60683	500	VARIANTA	5.000
	45	27	8,9	PZD-2	•	60707	500	VARIANTA	5.000
	50	30	8,9	PZD-2	•	60730	200	VARIANTA	2.000
	60	36	8,9	PZD-2	•	60758	200	VARIANTA	2.000
	70	42	8,9	PZD-2	•	60775	200	VARIANTA	2.000
80	48	8,9	PZD-2	•	60785	200	VARIANTA	2.000	

Uitvoering: platverzonken kop met freesholtes

Aandrijving: Pozi-Drive

Draadtype: deeldraad

Materiaal: koolstofstaal

Oppervlakte: verzinkt geel, A3L **CHROME (VI) FREE +**

Kleurcode op het HECO-etiket

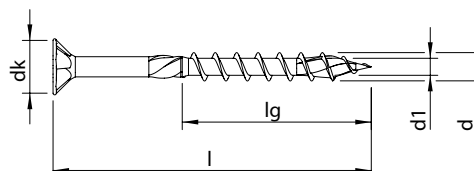

Afmeting d x l [mm]	Draadlengte lg [mm]	Kopdiameter dk [mm]	Aandrijving	ETA	Artikelnummer	Aantal per verpakking [st.]	Type verpakking	Aantal per omverpakking [st.]	
5,0 +	35	21	9,6	PZD-2	•	60856	500	VARIANTA	5.000
	40	24	9,6	PZD-2	•	60874	500	VARIANTA	2.500
	45	27	9,6	PZD-2	•	60890	200	VARIANTA	2.000
	50	30	9,6	PZD-2	•	60904	200	VARIANTA	2.000
	60	36	9,6	PZD-2	•	60928	200	VARIANTA	2.000
	70	42	9,6	PZD-2	•	60944	200	VARIANTA	2.000
	80	48	9,6	PZD-2	•	60956	200	VARIANTA	2.000
	90	54	9,6	PZD-2	•	60966	200	VARIANTA	2.000
	100	60	9,6	PZD-2	•	60977	100	VARIANTA	1.000
	120	60	9,6	PZD-2	•	60987	100	VARIANTA	1.000
6,0 +	45	27	11,7	PZD-3	•	61023	200	VARIANTA	2.000
	50	30	11,7	PZD-3	•	61032	200	VARIANTA	2.000
	60	36	11,7	PZD-3	•	61055	200	VARIANTA	2.000
	70	42	11,7	PZD-3	•	61075	200	VARIANTA	2.000
	80	48	11,7	PZD-3	•	61087	100	VARIANTA	1.000
	90	54	11,7	PZD-3	•	61101	100	VARIANTA	1.000
	100	60	11,7	PZD-3	•	61110	100	VARIANTA	1.000
	120	72	11,7	PZD-3	•	61131	100	VARIANTA	1.000



Uitvoering: kleine platverzonken kop

Aandrijving: Pozi-Drive

Draadtype: variabele voldraad

Materiaal: koolstofstaal

Oppervlakte: verzinkt blauw, A3K **CHROME (VI) FREE +**

Kleurcode op het HECO-etiket

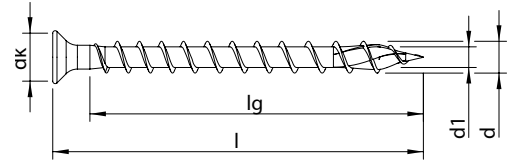

Afmeting d x l [mm]	Draadlengte lg [mm]	Kopdiameter dk [mm]	Aandrijving	ETA	Artikelnummer	Aantal per verpakking [st.]	Type verpakking	Aantal per omverpakking [st.]
3,0	12	9	5,0	PZD-1	60046	200	SKV	4.800
+	16	13	5,0	PZD-1	60070	200	SKV	4.800
	20	17	5,0	PZD-1	60091	200	SKV	4.800
	25	22	5,0	PZD-1	60109	200	SKV	4.800

Uitvoering: platverzonken kop met koptgatboring 2,4 mm *

Aandrijving: Pozi-Drive

Draadtype: variabele voldraad

Materiaal: koolstofstaal

Oppervlakte: verzinkt blauw, A3K **CHROME (VI) FREE +**

Kleurcode op het HECO-etiket

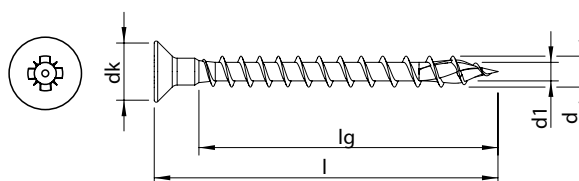

Afmeting d x l [mm]	Draadlengte lg [mm]	Kopdiameter dk [mm]	Aandrijving	ETA	Artikelnummer	Aantal per verpakking [st.]	Type verpakking	Aantal per omverpakking [st.]	
4,0 +	25	17	7,9	PZD-2	•	60399	200	SKV	4.800
	30	22	7,9	PZD-2	•	60422	200	SKV	4.800
	35	27	7,9	PZD-2	•	60446	200	SKV	4.000
	40	32	7,9	PZD-2	•	60467	200	SKV	4.000
	45	37	7,9	PZD-2	•	60496	200	SKV	4.000
	50	42	7,9	PZD-2	•	60518	200	SKV	4.000
	60	52	7,9	PZD-2	•	60553	200	VARIANTA	2.000
4,5 +	20	11	8,9	PZD-2	•	60592	200	SKV	4.800
	25	16	8,9	PZD-2	•	60609	200	SKV	4.800
	30	21	8,9	PZD-2	•	60627	200	SKV	4.000
	35	26	8,9	PZD-2	•	60649	200	SKV	4.000
	40	31	8,9	PZD-2	•	60672	200	SKV	4.000
	45	36	8,9	PZD-2	•	60696	200	SKV	4.000
	50	41	8,9	PZD-2	•	60718	200	VARIANTA	2.000
	60	51	8,9	PZD-2	•	60749	200	VARIANTA	2.000
5,0 +	60	50	9,6	PZD-2	•	60921	200	VARIANTA	2.000
	70	60	9,6	PZD-2	•	60937	200	VARIANTA	2.000
	80	70	9,6	PZD-2	•	60951	200	VARIANTA	2.000

* U vindt geschikte afdekkappen op pagina 97



Uitvoering:	rondkop
Aandrijving:	T-Drive
Draadtype:	variabele veldraad
Materiaal:	koolstofstaal
Oppervlakte:	verzinkt blauw, A3K CHROME (VI) FREE +

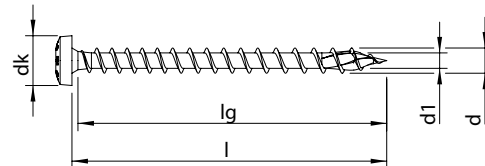

Afmeting d x l [mm]	Draadlengte lg [mm]	Kopdiameter dk [mm]	Aandrijving	ETA	Artikelnummer	Aantal per verpakking [st.]	Type verpakking	Aantal per omverpakking [st.]	
3,5	12	10	6,9	T-20		60180	1.000	VARIANTA	10.000
	16	14	6,9	T-20	●	60203	1.000	VARIANTA	10.000
	20	18	6,9	T-20	●	62664	200	SKV	4.800
	20	18	6,9	T-20	●	60223	1.000	VARIANTA	10.000
	25	23	6,9	T-20	●	62665	200	SKV	4.000
	25	23	6,9	T-20	●	60246	1.000	VARIANTA	10.000
	30	28	6,9	T-20	●	62666	200	SKV	4.000
	30	28	6,9	T-20	●	60268	1.000	VARIANTA	10.000
	35	33	6,9	T-20	●	62667	200	SKV	4.000
	35	33	6,9	T-20	●	60292	1.000	VARIANTA	5.000
4,0	12	10	7,9	T-20		60359	1.000	VARIANTA	10.000
	16	14	7,9	T-20		60380	1.000	VARIANTA	10.000
	20	18	7,9	T-20	●	62668	200	SKV	4.800
	20	18	7,9	T-20	●	60397	1.000	VARIANTA	10.000
	25	23	7,9	T-20	●	62669	200	SKV	4.000
	25	23	7,9	T-20	●	60419	1.000	VARIANTA	5.000
	30	28	7,9	T-20	●	62670	200	SKV	4.000
	30	28	7,9	T-20	●	60442	500	VARIANTA	5.000
	35	33	7,9	T-20	●	62671	200	SKV	4.000
	35	33	7,9	T-20	●	60465	500	VARIANTA	5.000
	40	38	7,9	T-20	●	62672	200	SKV	4.000
	40	38	7,9	T-20	●	60494	500	VARIANTA	5.000
	45	43	7,9	T-20	●	62673	200	SKV	4.000
	45	43	7,9	T-20	●	60517	500	VARIANTA	5.000
	50	48	7,9	T-20	●	62674	200	SKV	4.000
50	48	7,9	T-20	●	60543	500	VARIANTA	5.000	

Uitvoering: rondkop

Aandrijving: T-Drive

Draadtype: variabele voldraad

Materiaal: koolstofstaal

Oppervlakte: verzinkt blauw, A3K **CHROME (VI) FREE +**

Kleurcode op het HECO-etiket

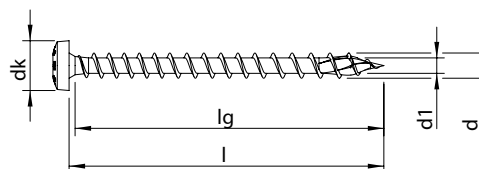

Afmeting d x l [mm]	Draadlengte lg [mm]	Kopdiameter dk [mm]	Aandrijving	ETA	Artikelnummer	Aantal per verpakking [st.]	Type verpakking	Aantal per omverpakking [st.]
4,5 ★	16	13	8,9	T-20		500	VARIANTA	5.000
	20	17	8,9	T-20	●	200	SKV	4.800
	20	17	8,9	T-20	●	500	VARIANTA	5.000
	25	22	8,9	T-20	●	200	SKV	4.000
	25	22	8,9	T-20	●	500	VARIANTA	5.000
	30	27	8,9	T-20	●	200	SKV	4.000
	30	27	8,9	T-20	●	500	VARIANTA	5.000
	35	32	8,9	T-20	●	200	SKV	4.000
	35	32	8,9	T-20	●	500	VARIANTA	5.000
	40	37	8,9	T-20	●	200	SKV	4.000
	40	37	8,9	T-20	●	500	VARIANTA	5.000
	45	42	8,9	T-20	●	200	SKV	4.000
	45	42	8,9	T-20	●	500	VARIANTA	2.500
	50	47	8,9	T-20	●	200	VARIANTA	2.000
5,0 ★	16	13	9,6	T-20		500	VARIANTA	5.000
	20	17	9,6	T-20		200	SKV	4.000
	20	17	9,6	T-20		500	VARIANTA	5.000
	25	22	9,6	T-20	●	200	SKV	4.000
	25	22	9,6	T-20	●	500	VARIANTA	5.000
	30	27	9,6	T-20	●	200	SKV	4.000
	30	27	9,6	T-20	●	500	VARIANTA	5.000
	35	32	9,6	T-20	●	200	SKV	4.000
	35	32	9,6	T-20	●	500	VARIANTA	2.500
	40	37	9,6	T-20	●	200	VARIANTA	2.000
	50	47	9,6	T-20	●	200	VARIANTA	2.000
6,0 ★	60	57	9,6	T-20	●	200	VARIANTA	2.000
	40	36	11,6	T-30	●	200	VARIANTA	2.000
	50	46	11,6	T-30	●	200	VARIANTA	2.000
	60	56	11,6	T-30	●	200	VARIANTA	1.000
	80	76	11,6	T-30	●	100	VARIANTA	1.000



Uitvoering:	rondkop
Aandrijving:	T-Drive
Draadtype:	variabele voldraad
Materiaal:	roestvaststaal A2 1.4567
Oppervlakte:	blank, glijcoating

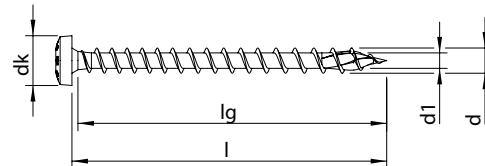

Afmeting d x l [mm]	Draadlengte lg [mm]	Kopdiameter dk [mm]	Aandrijving	ETA	Artikelnummer	Aantal per verpakking [st.]	Type verpakking	Aantal per omverpakking [st.]
3,0 	20	18	5,9	T-10	61978	200	SKV	4.800
	30	28	5,9	T-10	61979	200	SKV	4.000
3,5 	20	18	6,9	T-20	61980	200	SKV	4.800
	30	28	6,9	T-20	61981	200	SKV	4.800
4,0 	20	18	7,9	T-20	61982	200	SKV	4.800
	25	23	7,9	T-20	61983	200	SKV	4.000
	30	28	7,9	T-20	61984	200	SKV	4.000
	35	33	7,9	T-20	61985	200	SKV	4.000
	40	38	7,9	T-20	61986	200	SKV	4.000
	45	43	7,9	T-20	61987	200	SKV	4.000
5,0 	50	48	7,9	T-20	61988	200	SKV	4.000
	25	22	9,6	T-20	61989	200	SKV	4.000
	30	27	9,6	T-20	61990	200	SKV	4.000
	40	37	9,6	T-20	61991	200	SKV	4.000
	50	47	9,6	T-20	61992	200	VARIANTA	2.000

Uitvoering: rondkop

Aandrijving: Pozi-Drive

Draadtype: variabele voldraad

Materiaal: koolstofstaal

Oppervlakte: verzinkt blauw, A3K **CHROME (VI) FREE +**

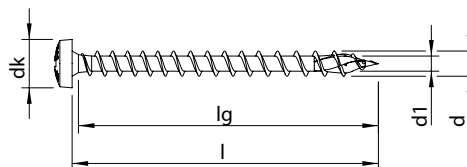

Afmeting d x l [mm]	Draadlengte lg [mm]	Kopdiameter dk [mm]	Aandrijving	ETA	Artikelnummer	Aantal per verpakking [st.]	Type verpakking	Aantal per omverpakking [st.]	
3,0	12	10	5,9	PZD-1	60042	200	SKV	4.800	
	+	12	10	5,9	PZD-1	60043	1.000	VARIANTA	10.000
	15	13	5,9	PZD-1	60053	200	SKV	4.800	
	15	13	5,9	PZD-1	60054	1.000	VARIANTA	10.000	
	16	14	5,9	PZD-1	60066	200	SKV	4.800	
	16	14	5,9	PZD-1	60067	1.000	VARIANTA	10.000	
	20	18	5,9	PZD-1	60086	200	SKV	4.800	
	20	18	5,9	PZD-1	60087	1.000	VARIANTA	10.000	
	25	23	5,9	PZD-1	60105	200	SKV	4.800	
	25	23	5,9	PZD-1	60106	1.000	VARIANTA	10.000	
3,5	30	28	5,9	PZD-1	60126	200	SKV	4.000	
	30	28	5,9	PZD-1	60127	1.000	VARIANTA	10.000	
	+	12	10	6,9	PZD-2	60178	200	SKV	4.800
	12	10	6,9	PZD-2	60179	1.000	VARIANTA	10.000	
	15	13	6,9	PZD-2	60188	200	SKV	4.800	
	15	13	6,9	PZD-2	60189	1.000	VARIANTA	10.000	
	16	14	6,9	PZD-2	• 60199	200	SKV	4.800	
	16	14	6,9	PZD-2	• 60200	1.000	VARIANTA	10.000	
	20	18	6,9	PZD-2	• 60219	200	SKV	4.800	
	20	18	6,9	PZD-2	• 60220	1.000	VARIANTA	10.000	
25	23	6,9	PZD-2	• 60242	200	SKV	4.000		
25	23	6,9	PZD-2	• 60243	1.000	VARIANTA	10.000		
30	28	6,9	PZD-2	• 60265	200	SKV	4.000		
30	28	6,9	PZD-2	• 60266	1.000	VARIANTA	10.000		
35	33	6,9	PZD-2	• 60288	200	SKV	4.000		
35	33	6,9	PZD-2	• 60289	1.000	VARIANTA	5.000		
40	38	6,9	PZD-2	• 60313	200	SKV	4.000		
40	38	6,9	PZD-2	• 60314	500	VARIANTA	5.000		



Uitvoering:	rondkop
Aandrijving:	Pozi-Drive
Draadtype:	variabele voldraad
Materiaal:	koolstofstaal
Oppervlakte:	verzinkt blauw, A3K CHROME (VI) FREE +

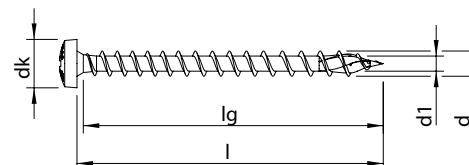

Afmeting d x l [mm]	Draadlengte lg [mm]	Kopdiameter dk [mm]	Aandrijving	ETA	Artikelnummer	Aantal per verpakking [st.]	Type verpakking	Aantal per omverpakking [st.]
4,0 	12	10	7,9	PZD-2	60356	200	SKV	4.800
	12	10	7,9	PZD-2	60357	1.000	VARIANTA	10.000
	15	13	7,9	PZD-2	60366	200	SKV	4.800
	15	13	7,9	PZD-2	60367	1.000	VARIANTA	10.000
	16	14	7,9	PZD-2	60377	200	SKV	4.800
	16	14	7,9	PZD-2	60378	1.000	VARIANTA	10.000
	20	18	7,9	PZD-2	• 60394	200	SKV	4.800
	20	18	7,9	PZD-2	• 60395	1.000	VARIANTA	10.000
	25	23	7,9	PZD-2	• 60416	200	SKV	4.000
	25	23	7,9	PZD-2	• 60417	1.000	VARIANTA	5.000
	30	28	7,9	PZD-2	• 60438	200	SKV	4.000
	30	28	7,9	PZD-2	• 60439	500	VARIANTA	5.000
	35	33	7,9	PZD-2	• 60462	200	SKV	4.000
	35	33	7,9	PZD-2	• 60463	500	VARIANTA	5.000
	40	38	7,9	PZD-2	• 60491	200	SKV	4.000
	40	38	7,9	PZD-2	• 60492	500	VARIANTA	5.000
	45	43	7,9	PZD-2	• 60513	200	SKV	4.000
	45	43	7,9	PZD-2	• 60514	500	VARIANTA	5.000
	50	48	7,9	PZD-2	• 60540	200	SKV	4.000
50	48	7,9	PZD-2	• 60541	500	VARIANTA	5.000	
60	58	7,9	PZD-2	• 60563	200	VARIANTA	2.000	

Uitvoering: rondkop

Aandrijving: Pozi-Drive

Draadtype: variabele voldraad

Materiaal: koolstofstaal

Oppervlakte: verzinkt blauw, A3K **CHROME (VI) FREE +**

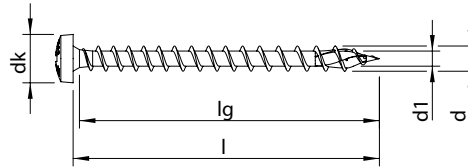

Afmeting d x l [mm]	Draadlengte lg [mm]	Kopdiameter dk [mm]	Aandrijving	ETA	Artikelnummer	Aantal per verpakking [st.]	Type verpakking	Aantal per omverpakking [st.]
4,5 	15	12	8,9	PZD-2	60579	200	SKV	4.800
	15	12	8,9	PZD-2	60580	500	VARIANTA	5.000
	16	13	8,9	PZD-2	60587	200	SKV	4.800
	16	13	8,9	PZD-2	60588	500	VARIANTA	5.000
	20	17	8,9	PZD-2	60603	200	SKV	4.800
	20	17	8,9	PZD-2	60604	500	VARIANTA	5.000
	25	22	8,9	PZD-2	• 60621	200	SKV	4.000
	25	22	8,9	PZD-2	• 60622	500	VARIANTA	5.000
	30	27	8,9	PZD-2	• 60643	200	SKV	4.000
	30	27	8,9	PZD-2	• 60644	500	VARIANTA	5.000
	35	32	8,9	PZD-2	• 60664	200	SKV	4.000
	35	32	8,9	PZD-2	• 60665	500	VARIANTA	5.000
	40	37	8,9	PZD-2	• 60688	200	SKV	4.000
	40	37	8,9	PZD-2	• 60689	500	VARIANTA	5.000
	45	42	8,9	PZD-2	• 60712	200	SKV	4.000
	45	42	8,9	PZD-2	• 60713	500	VARIANTA	2.500
	50	47	8,9	PZD-2	• 60736	200	VARIANTA	2.000
	60	57	8,9	PZD-2	• 60763	200	VARIANTA	2.000



Uitvoering:	rondkop
Aandrijving:	Pozi-Drive
Draadtype:	variabele voldraad
Materiaal:	koolstofstaal
Oppervlakte:	verzinkt blauw, A3K CHROME (VI) FREE +

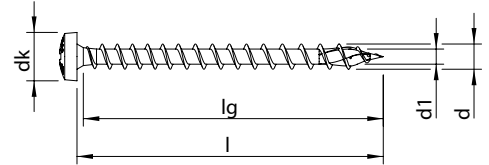

Afmeting d x l [mm]	Draadlengte lg [mm]	Kopdiameter dk [mm]	Aandrijving	ETA	Artikelnummer	Aantal per verpakking [st.]	Type verpakking	Aantal per omverpakking [st.]
5,0 	16	13	9,6	PZD-2	60797	200	SKV	4.000
	16	13	9,6	PZD-2	60798	500	VARIANTA	5.000
	20	17	9,6	PZD-2	60809	200	SKV	4.000
	20	17	9,6	PZD-2	60810	500	VARIANTA	5.000
	25	22	9,6	PZD-2	● 60823	200	SKV	4.000
	25	22	9,6	PZD-2	● 60824	500	VARIANTA	5.000
	30	27	9,6	PZD-2	● 60842	200	SKV	4.000
	30	27	9,6	PZD-2	● 60843	500	VARIANTA	5.000
	35	32	9,6	PZD-2	● 60860	200	SKV	4.000
	35	32	9,6	PZD-2	● 60861	500	VARIANTA	2.500
	40	37	9,6	PZD-2	● 60880	200	VARIANTA	2.000
	50	47	9,6	PZD-2	● 60909	200	VARIANTA	2.000
	60	57	9,6	PZD-2	● 60933	200	VARIANTA	2.000
	70	67	9,6	PZD-2	● 60949	200	VARIANTA	2.000
	80	77	9,6	PZD-2	● 60962	200	VARIANTA	2.000

Uitvoering:	rondkop
Aandrijving:	Pozi-Drive
Draadtype:	variabele voldraad
Materiaal:	koolstofstaal
Oppervlakte:	verzinkt blauw, A3K CHROME (VI) FREE +

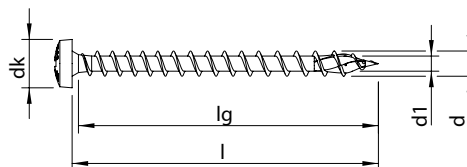

Afmeting d x l [mm]	Draadlengte lg [mm]	Kopdiameter dk [mm]	Aandrijving	ETA	Artikelnummer	Aantal per verpakking [st.]	Type verpakking	Aantal per omverpakking [st.]	
6,0	30	26	11,6	PZD-3	•	60998	200	VARIANTA	2.000
+	35	31	11,6	PZD-3	•	61003	200	VARIANTA	2.000
	40	36	11,6	PZD-3	•	61010	200	VARIANTA	2.000
	50	46	11,6	PZD-3	•	61036	200	VARIANTA	2.000
	60	56	11,6	PZD-3	•	61059	200	VARIANTA	2.000
	70	66	11,6	PZD-3	•	61079	200	VARIANTA	1.000
	80	76	11,6	PZD-3	•	61092	100	VARIANTA	1.000



Uitvoering: rondkop

Aandrijving: Pozi-Drive

Draadtype: variabele voldraad

Materiaal: roestvaststaal A2 1.4567

Oppervlakte: blank, glijcoating

Kleurcode op het HECO-etiket

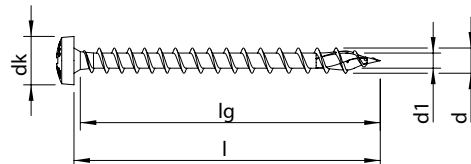

Afmeting d x l [mm]	Draadlengte lg [mm]	Kopdiameter dk [mm]	Aandrijving	ETA	Artikelnummer	Aantal per verpakking [st.]	Type verpakking	Aantal per omverpakking [st.]
3,0 +	20	18	5,9	PZD-1	61620	200	SKV	4.800
	30	28	5,9	PZD-1	61627	200	SKV	4.000
3,5 +	20	18	6,9	PZD-2	61633	200	SKV	4.800
	30	28	6,9	PZD-2	61639	200	SKV	4.800
4,0 +	20	18	7,9	PZD-2	61659	200	SKV	4.800
	25	23	7,9	PZD-2	61664	200	SKV	4.000
	30	28	7,9	PZD-2	61670	200	SKV	4.000
	35	33	7,9	PZD-2	61675	200	SKV	4.000
	40	38	7,9	PZD-2	61679	200	SKV	4.000
	45	43	7,9	PZD-2	61683	200	SKV	4.000
5,0 +	50	48	7,9	PZD-2	61687	200	SKV	4.000
	25	22	9,6	PZD-2	61729	200	SKV	4.000
	30	27	9,6	PZD-2	61732	200	SKV	4.000
	40	37	9,6	PZD-2	61747	200	SKV	4.000
	50	47	9,6	PZD-2	61764	200	VARIANTA	2.000



Uitvoering: verzonken lenskop met freesholtes

Aandrijving: HECO-Drive *





Draadtype: variabele voldraad

Materiaal: roestvaststaal A2 1.4567

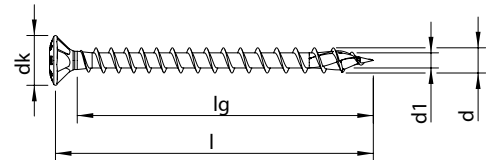
Oppervlakte: blank, glijcoating

Kleurcode op het HECO-etiket



Afmeting d x l [mm]	Draadlengte lg [mm]	Kopdiameter dk [mm]	Aandrijving	ETA	Artikelnummer	Aantal per verpakking [st.]	Type verpakking	Aantal per omverpakking [st.]	
3,5 	20	16	7,3	HD-20	•	61997	200	SKV	4.800
	25	21	7,3	HD-20	•	61998	200	SKV	4.800
	30	26	7,3	HD-20	•	61999	200	SKV	4.800
	35	31	7,3	HD-20	•	62000	200	SKV	4.000
	40	36	7,3	HD-20	•	62001	200	SKV	4.000
4,0 	20	15	7,9	HD-20	•	62002	200	SKV	4.800
	25	20	7,9	HD-20	•	62003	200	SKV	4.800
	30	25	7,9	HD-20	•	62004	200	SKV	4.800
	35	30	7,9	HD-20	•	62005	200	SKV	4.000
	40	35	7,9	HD-20	•	62006	200	SKV	4.000
	50	45	7,9	HD-20	•	62007	200	SKV	4.000
4,5 	40	35	8,9	HD-20	•	62008	200	SKV	4.000
	50	45	8,9	HD-20	•	62010	200	VARIANTA	2.000
5,0 	50	44	9,6	HD-20	•	62011	200	VARIANTA	2.000
	60	54	9,6	HD-20	•	62012	200	VARIANTA	2.000

* Alle schroeven met HECO-Drive zijn 100% compatibel met conventionele TX-bits.
Het GripFit-effect is alleen gegarandeerd bij gebruik met bijpassende HECO-Drive-bits.

Uitvoering: verzonken lenskop met freesholtes

Aandrijving: Pozi-Drive

Draadtype: variabele voldraad

Materiaal: roestvaststaal A2 1.4567

Oppervlakte: blank, glijcoating

Kleurcode op het HECO-etiket

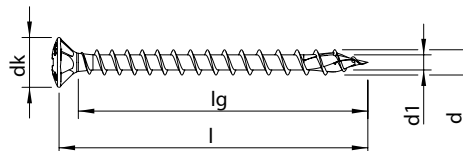

Afmeting d x l [mm]	Draadlengte lg [mm]	Kopdiameter dk [mm]	Aandrijving	ETA	Artikelnummer	Aantal per verpakking [st.]	Type verpakking	Aantal per omverpakking [st.]	
3,5 +	20	16	7,3	PZD-2	•	61632	200	SKV	4.800
	25	21	7,3	PZD-2	•	61635	200	SKV	4.800
	30	26	7,3	PZD-2	•	61638	200	SKV	4.800
	35	31	7,3	PZD-2	•	61643	200	SKV	4.000
	40	36	7,3	PZD-2	•	61648	200	SKV	4.000
4,0 +	20	15	7,9	PZD-2	•	61658	200	SKV	4.800
	25	20	7,9	PZD-2	•	61663	200	SKV	4.800
	30	25	7,9	PZD-2	•	61669	200	SKV	4.800
	35	30	7,9	PZD-2	•	61674	200	SKV	4.000
	40	35	7,9	PZD-2	•	61678	200	SKV	4.000
	50	45	7,9	PZD-2	•	61686	200	SKV	4.000
4,5 +	40	35	8,9	PZD-2	•	61700	200	SKV	4.000
	50	45	8,9	PZD-2	•	61710	200	VARIANTA	2.000
5,0 +	50	44	9,6	PZD-2	•	61763	200	VARIANTA	2.000
	60	54	9,6	PZD-2	•	61776	200	VARIANTA	2.000

75



Uitvoering: Achterwandschroef, tellerkop

Aandrijving: T-Drive

Draadtype: variabele voldraad

Materiaal: koolstofstaal

Oppervlakte: verzinkt blauw, A3K **CHROME (VI) FREE +**

Kleurcode op het HECO-etiket

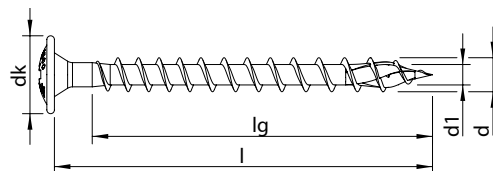

Afmeting d x l [mm]	Draadlengte lg [mm]	Kopdiameter dk [mm]	Aandrijving	ETA	Artikelnummer	Aantal per verpakking [st.]	Type verpakking	Aantal per omverpakking [st.]
3,0 ★	20	18	8,0	T-10	61959	1.000	VARIANTA	10.000
	25	23	8,0	T-10	61960	1.000	VARIANTA	10.000
	30	28	8,0	T-10	61961	1.000	VARIANTA	10.000
	35	33	8,0	T-10	61962	500	VARIANTA	5.000
3,5 ★	20	17	8,2	T-20	• 61963	1.000	VARIANTA	10.000
	25	22	8,2	T-20	• 61964	1.000	VARIANTA	10.000
	30	27	8,2	T-20	• 61965	500	VARIANTA	5.000
	35	32	8,2	T-20	• 61966	500	VARIANTA	5.000
4,0 ★	25	22	9,2	T-20	• 61967	500	VARIANTA	5.000
	30	27	9,2	T-20	• 61968	500	VARIANTA	5.000
	35	32	9,2	T-20	• 61969	500	VARIANTA	5.000
	40	37	9,2	T-20	• 61970	500	VARIANTA	5.000
4,5 ★	25	22	10,3	T-20	• 61971	1.000	VARIANTA	5.000
	30	27	10,3	T-20	• 61972	500	VARIANTA	5.000
	35	32	10,3	T-20	• 61973	500	VARIANTA	5.000
	40	37	10,3	T-20	• 61974	200	VARIANTA	2.000
	45	42	10,3	T-20	• 61975	200	VARIANTA	2.000
50	47	10,3	T-20	• 61976	200	VARIANTA	2.000	
5,0*	60	56	11,8	T-20	• 61977	200	VARIANTA	2.000

* Kleurcode HD bit = ★

Uitvoering: Achterwandschroef, tellerkop

Aandrijving: Pozi-Drive

Draadtype: variabele voldraad

Materiaal: koolstofstaal

Oppervlakte: verzinkt blauw, A3K **CHROME (VI) FREE +**

Kleurcode op het HECO-etiket

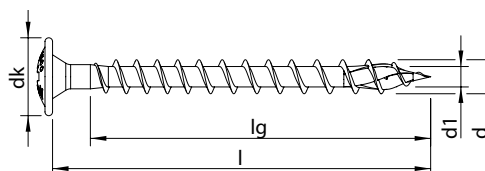
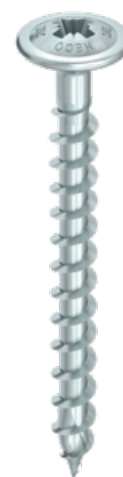

Afmeting d x l [mm]	Draadlengte lg [mm]	Kopdiameter dk [mm]	Aandrijving	ETA	Artikelnummer	Aantal per verpakking [st.]	Type verpakking	Aantal per omverpakking [st.]
3,0 +	20	18	8,0	PZD-2	60076	1.000	VARIANTA	10.000
	25	23	8,0	PZD-2	60094	1.000	VARIANTA	10.000
	30	28	8,0	PZD-2	60111	1.000	VARIANTA	10.000
	35	33	8,0	PZD-2	60132	500	VARIANTA	5.000
3,5 +	20	17	8,2	PZD-2	60208	1.000	VARIANTA	10.000
	25	22	8,2	PZD-2	60224	1.000	VARIANTA	10.000
	30	27	8,2	PZD-2	60248	500	VARIANTA	5.000
	35	32	8,2	PZD-2	60269	500	VARIANTA	5.000
4,0 +	25	22	9,2	PZD-2	60398	500	VARIANTA	5.000
	30	27	9,2	PZD-2	60421	500	VARIANTA	5.000
	35	32	9,2	PZD-2	60445	500	VARIANTA	5.000
4,5 +	25	22	10,3	PZD-2	60608	1.000	VARIANTA	5.000
	30	27	10,3	PZD-2	60626	500	VARIANTA	5.000
	35	32	10,3	PZD-2	60648	500	VARIANTA	5.000
5,0*	40	37	10,3	PZD-2	60670	200	VARIANTA	2.000
	45	42	10,3	PZD-2	60695	200	VARIANTA	2.000
	50	47	10,3	PZD-2	60717	200	VARIANTA	2.000
5,0*	60	56	11,8	PZD-2	60920	200	VARIANTA	2.000

* Kleurcode PZD bit = **+**

HECO-TOPIX®-plus Vloerplaatschroef

Productinformatie

- Aantrekken en fixeren met slechts één schroef
- Gereduceerde splijtwerking bij het inschroeven door boorpunt
- Snel aanzetten en inschroeven, in het bijzonder op harde oppervlakten
- Geen knarsen van het hout dankzij fixatie met de voldraad
- Tijdsbesparing door de inzet van één schroefvariant
- Goedgekeurd en bewaakt product (CE-markering)



De unieke vloerplaatschroef met het samentrekeffect

Platverzonken kop met freesholtes

Uitstekende freeseigenschappen in hout. Geen beschadiging van het oppervlak bij metalen beslag.

MagicClose®

Gepatenteerde voldraad trekt houten onderdelen spleetvrij samen zonder voorspannen



HECO-TOPIX-plus-punt

Maakt voorboren overbodig en vermindert het risico van splijten van het hout

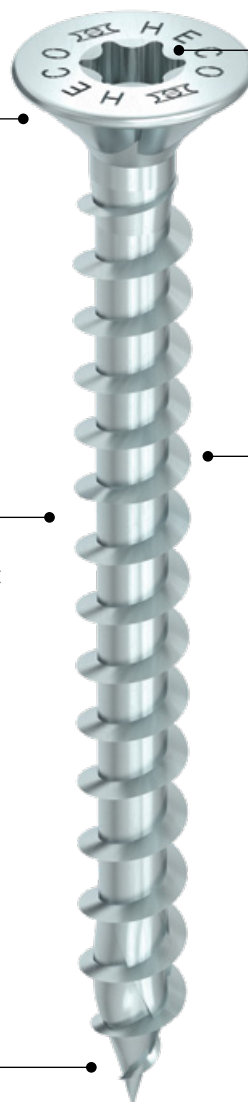

GripFit®

HECO-Drive maakt werken met één hand mogelijk



PerfectPitch®

Optimale schroefdraadspeed voor elke schroeflengte



Uitvoering: Vloerplaatschroef, platverzonken kop met freesholtes

Aandrijving: HECO-Drive *

Draadtype: variabele voldraad

Materiaal: koolstofstaal

Oppervlakte: verzinkt blauw, A3K **CHROME (VI) FREE +**

Kleurcode op het HECO-etiket

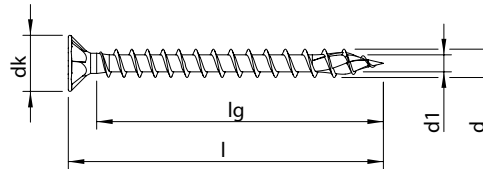

Afmeting d x l [mm]	Draadlengte lg [mm]	Kopdiameter dk [mm]	Aandrijving	ETA	Artikelnummer	Aantal per verpakking [st.]	Type verpakking	Aantal per omverpakking [st.]	
4,5	40	35	8,9	HD-20	•	62107	500	VARIANTA	5.000
	50	45	8,9	HD-20	•	60722	200	VARIANTA	2.000
	60	55	8,9	HD-20	•	60752	200	VARIANTA	2.000
	70	65	8,9	HD-20	•	60769	200	VARIANTA	2.000
	80	75	8,9	HD-20	•	60781	200	VARIANTA	2.000

* Alle schroeven met HECO-Drive zijn 100% compatibel met conventionele TX-bits.
Het GripFit-effect is alleen gegarandeerd bij gebruik met bijpassende HECO-Drive-bits.

HECO-TOPIX[®]-plus Vloerschroef

Productinformatie

- Aantrekken en fixeren met slechts één schroef
- Gereduceerde splijtwerking bij het inschroeven door boorpunt
- Geen knarsen van de vloerplanken door vaste fixering met de voldraad
- Makkelijk verzinken van de kop in de veer en verminderde spreidwerking
- Tijdsbesparing door de inzet van één schroefvariant
- Goedgekeurd en bewaakt product (CE-markering)



De unieke vloerschroef met het samentrekeffect

Kleine lenskop met freesribben

Voor gemakkelijk verzinken in de veer

MagicClose[®]

Gepatenteerde voldraad trekt houten onderdelen spleetvrij samen zonder voorspannen

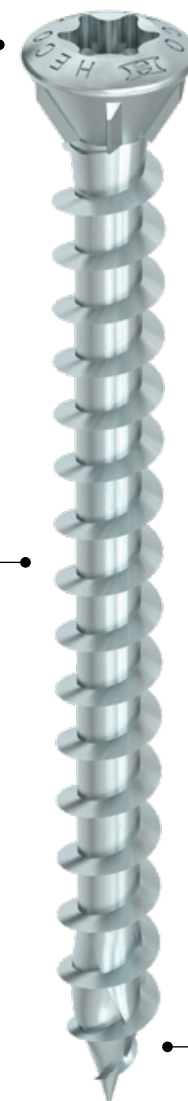

PerfectPitch[®]

Optimale schroefdraadspoed voor elke schroeflengte



HECO-TOPIX-plus-punt

Maakt voorboren overbodig en vermindert het risico van splijten van het hout

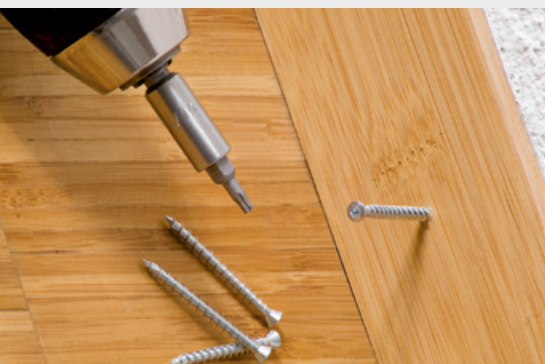

Uitvoering: Vloerschroef, verzonken lenskop met freesribben

Aandrijving: T-Drive



Draadtype: variabele voldraad

Materiaal: koolstofstaal

Oppervlakte: verzinkt blauw, A3K **CHROME (VI) FREE +**

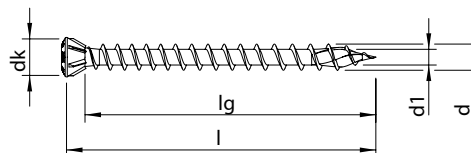
Kleurcode op het HECO-etiket



Afmeting d x l [mm]	Draadlengte lg [mm]	Kopdiameter dk [mm]	Aandrijving	ETA	Artikelnummer	Aantal per verpakking [st.]	Type verpakking	Aantal per omverpakking [st.]	
3,5 	40	37	5,3	T-10	•	60293	200	SKV	4.000
	40	37	5,3	T-10	•	60294	500	VARIANTA	5.000
	50	47	5,3	T-10	•	60328	200	SKV	4.000
	50	47	5,3	T-10	•	60329	500	VARIANTA	5.000
	60	57	5,3	T-10	•	60346	200	VARIANTA	2.000
	60	57	5,3	T-10	•	60348	500	VARIANTA	5.000
4,0 	40	36	6,1	T-15	•	64596 NIEUW	500	VARIANTA	5.000
	50	46	6,1	T-15	•	64597 NIEUW	500	VARIANTA	5.000
	60	56	6,1	T-15	•	64598 NIEUW	500	VARIANTA	5.000
	70	66	6,1	T-15	•	60564	200	VARIANTA	2.000
	70	66	6,1	T-15	•	60565	500	O-BOX	2.000
4,5 	50	46	6,8	T-20	•	60719	200	VARIANTA	2.000
	50	46	6,8	T-20	•	60721	500	VARIANTA	5.000
	60	56	6,8	T-20	•	60750	200	VARIANTA	2.000
	60	56	6,8	T-20	•	60751	500	O-BOX	2.000
	70	66	6,8	T-20	•	60766	200	VARIANTA	2.000
	70	66	6,8	T-20	•	60768	500	O-BOX	2.000
	80	76	6,8	T-20	•	60779	200	VARIANTA	2.000
	80	76	6,8	T-20	•	60780	500	O-BOX	2.000



Uitvoering: Vloerschroef, verzonken lenskop met freesribben

Aandrijving: T-Drive



Draadtype: variabele voldraad

Materiaal: roestvaststaal A2 1.4567

Oppervlakte: blank, glijcoating

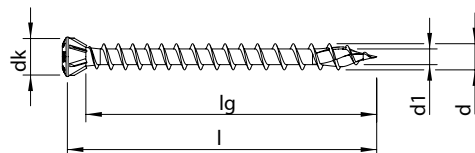
Kleurcode op het HECO-etiket



Afmeting d x l [mm]	Draadlengte lg [mm]	Kopdiameter dk [mm]	Aandrijving	ETA	Artikelnummer	Aantal per verpakking [st.]	Type verpakking	Aantal per omverpakking [st.]	
3,5	40	37	5,3	T-10	●	61644	200	SKV	4.000
	 50	47	5,3	T-10	●	61651	200	SKV	4.000
	60	57	5,3	T-10	●	61654	200	SKV	4.000
4,0	40	36	6,1	T-15	●	64599 NIEUW	200	SKV	4.000
	 50	46	6,1	T-15	●	64600 NIEUW	200	SKV	4.000
	60	56	6,1	T-15	●	64601 NIEUW	200	SKV	4.000



Uitvoering: Vloerschroef, verzonken cilinderkop

Aandrijving: T-Drive

Draadtype: variabele voldraad

Materiaal: roestvaststaal A2 1.4567

Oppervlakte: blank, glijcoating

Kleurcode op het HECO-etiket

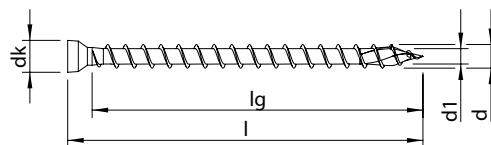

Afmeting d x l [mm]	Draadlengte lg [mm]	Kopdiameter dk [mm]	Aandrijving	ETA	Artikelnummer	Aantal per verpakking [st.]	Type verpakking	Aantal per omverpakking [st.]	
3,5*	40	36	4,3	T-10	●	64655 NIEUW	200	SKV	4.000

Beschikbaarheid en data op aanvraag.

** Kleurcode HD bit = 

HECO-TOPIX®-plus Gevelschroef

Productinformatie

- Aantrekken en fixeren van de gevelplank met één schroef
- Duurzame fixering en hogere aantreklasten dankzij HECO-TOPIX-plus voldraad
- Splijtvrij aantrekken van de gevelplank
- Uitvoering in roestvaststaal A2 voor duurzame en gestandaardiseerde montage voor gebruiksklasse 3
- Goedgekeurd en bewaakt product (CE-markering)



De unieke gevelschroef met het samentrekeffect

Kleine lenskop

Voor optische mooie montage en minder vochtophoping

GripFit®

HECO-Drive maakt werken met één hand mogelijk



MagicClose®

Gepatenteerde voldraad trekt houten onderdelen spleetvrij samen zonder voorspannen

PerfectPitch®

Optimale schroefdraadspoed voor elke schroeflengte



HECO-TOPIX-plus-punt

Maakt voorboren overbodig en vermindert het risico van splijten van het hout



Uitvoering: Gevelschroef, verzonken lenskop met freesribben

Aandrijving: HECO-Drive*

Draadtype: variabele voldraad

Materiaal: roestvaststaal A2 1.4567

Oppervlakte: blank, glijcoating

Kleurcode op het HECO-etiket

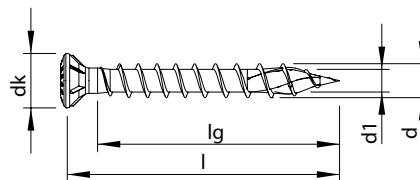

Afmeting d x l [mm]	Draadlengte lg [mm]	Kopdiameter dk [mm]	Aandrijving	ETA	Artikelnummer	Aantal per verpakking [st.]	Type verpakking	Aantal per omverpakking [st.]	
4,5 	50	45	7,2	HD-20	•	61706	200	VARIANTA	2.000
	60	55	7,2	HD-20	•	61711	200	VARIANTA	2.000
	70	65	7,2	HD-20	•	61715	200	VARIANTA	2.000
	80	75	7,2	HD-20	•	61720	200	VARIANTA	2.000
5,0 	40	34	7,2	HD-20	•	61743	200	VARIANTA	2.000
	50	44	7,2	HD-20	•	61759	200	VARIANTA	2.000
	60	54	7,2	HD-20	•	61772	200	VARIANTA	2.000
	70	64	7,2	HD-20	•	61783	200	VARIANTA	2.000
	80	74	7,2	HD-20	•	61793	200	VARIANTA	2.000

* Alle schroeven met HECO-Drive zijn 100% compatibel met conventionele TX-bits.
Het GripFit-effect is alleen gegarandeerd bij gebruik met bijpassende HECO-Drive-bits.

HECO-TOPIX®-plus Scharnierschroef

Productinformatie

- Geen beschadigingen van het beslag
- Remmende werking van de kop verhindert doordraaien van de schroef
- Van glijmiddel voorzien voor minimaal inschroefdraaimoment
- Universele toepassing in vele houtsoorten
- Coating zonder chroom-VI
- Goedgekeurd en bewaakt product (CE-markering)



De scharnierschroef voor de professional

Speciale kop met aangepaste helling

voor een snelle montage zonder het oppervlakte beschadigen
geen doordraaien van de schroef

GripFit®

HECO-Drive maakt werken met één hand mogelijk



PerfectPitch®

Optimale schroefdraadspoed voor elke schroeflengte



HECO-TOPIX-plus-punt

Maakt voorboren overbodig en vermindert het risico van splijten van het hout

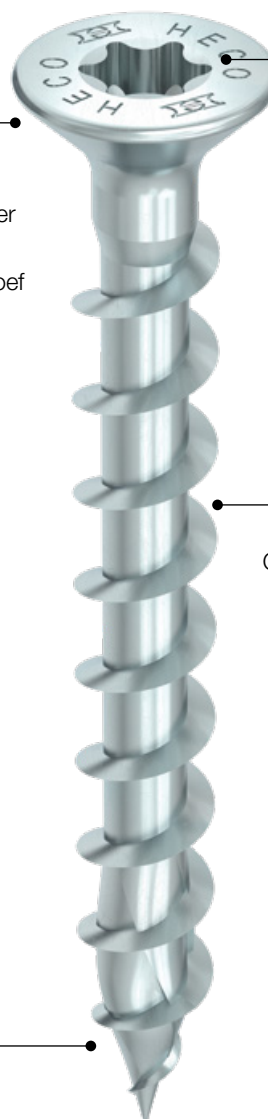

Uitvoering: Scharnierschroef, platverzonken kop met freesholtes

Aandrijving: **A** T-Drive **B** Pozi-Drive

Draadtype: voldraad

Materiaal: koolstofstaal

Oppervlakte: verzinkt blauw, A3K **CHROME (VI) FREE +**

Kleurcode op het HECO-etiket

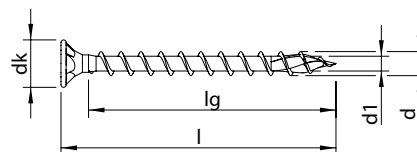
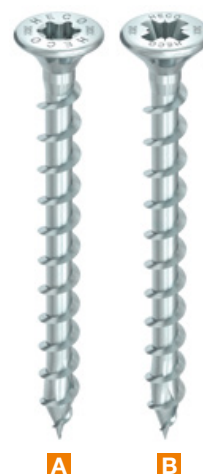

Afmeting d x l [mm]	Draadlengte lg [mm]	Kopdiameter dk [mm]	Aandrijving	ETA	Artikelnummer	Aantal per verpakking [st.]	Type verpakking	Aantal per omverpakking [st.]
3,5 	12	9	6,9	T-15	62236	1.000	VARIANTA	10.000
	16	13	6,9	T-15	62237	1.000	VARIANTA	10.000
	20	16	6,9	T-15	62238	1.000	VARIANTA	10.000
	25	21	6,9	T-15	62239	1.000	VARIANTA	10.000
	30	26	6,9	T-15	62240	1.000	VARIANTA	10.000
	35	31	6,9	T-15	62244	1.000	VARIANTA	10.000
	40	36	6,9	T-15	62241	500	VARIANTA	5.000
	50	46	6,9	T-15	62242	500	VARIANTA	5.000
3,5 	12	9	6,9	PZD-2	62229	1.000	VARIANTA	10.000
	16	13	6,9	PZD-2	62230	1.000	VARIANTA	10.000
	20	16	6,9	PZD-2	62231	1.000	VARIANTA	10.000
	25	21	6,9	PZD-2	62232	1.000	VARIANTA	10.000
	30	26	6,9	PZD-2	62233	1.000	VARIANTA	10.000
	35	31	6,9	PZD-2	62243	1.000	VARIANTA	10.000
	40	36	6,9	PZD-2	62234	500	VARIANTA	5.000
	50	46	6,9	PZD-2	62235	500	VARIANTA	5.000



Uitvoering: Scharnierschroef, platverzonken kop

Aandrijving: HECO-Drive*

Draadtype: voldraad

Materiaal: koolstofstaal

Oppervlakte: verzinkt blauw, A3K **CHROME (VI) FREE +**

Kleurcode op het HECO-etiket

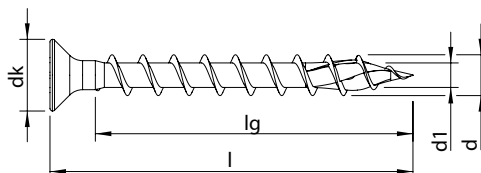

Afmeting d x l [mm]	Draadlengte lg [mm]	Kopdiameter dk [mm]	Aandrijving	ETA	Artikelnummer	Aantal per verpakking [st.]	Type verpakking	Aantal per omverpakking [st.]
---------------------	---------------------	---------------------	-------------	-----	---------------	-----------------------------	-----------------	-------------------------------

4,5**	40	35	7,9	HD-20	•	60694	500	VARIANTA	5.000
-------	----	----	-----	-------	---	-------	-----	----------	-------

* Alle schroeven met HECO-Drive zijn 100% compatibel met conventionele TX-bits.
Het GripFit-effect is alleen gegarandeerd bij gebruik met bijpassende HECO-Drive-bits.

** Kleurcode HD bit =



Uitvoering: Scharnierschroef, platverzonken kop

Aandrijving: HECO-Drive*

Draadtype: voldraad

Materiaal: roestvaststaal A2 1.4567

Oppervlakte: blank, glijcoating

Kleurcode op het HECO-etiket

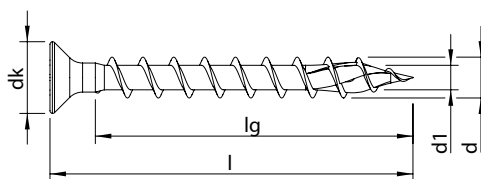

Afmeting d x l [mm]	Draadlengte lg [mm]	Kopdiameter dk [mm]	Aandrijving	ETA	Artikelnummer	Aantal per verpakking [st.]	Type verpakking	Aantal per omverpakking [st.]
---------------------	---------------------	---------------------	-------------	-----	---------------	-----------------------------	-----------------	-------------------------------

4,5**	40	35	7,9	HD-20	•	61701	500	VARIANTA	5.000
-------	----	----	-----	-------	---	-------	-----	----------	-------

* Alle schroeven met HECO-Drive zijn 100% compatibel met conventionele TX-bits.
Het GripFit-effect is alleen gegarandeerd bij gebruik met bijpassende HECO-Drive-bits.

** Kleurcode HD bit =

Uitvoering: Scharnierschroef, platverzonken kop

Aandrijving: Pozi-Drive

Draadtype: voldraad

Materiaal: koolstofstaal

Oppervlakte: verzinkt blauw, A3K **CHROME (VI) FREE +**

Kleurcode op het HECO-etiket

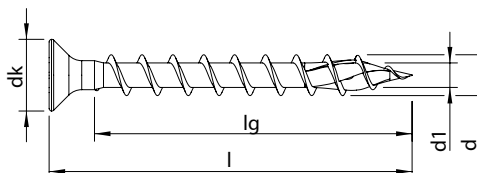

Afmeting d x l [mm]	Draadlengte lg [mm]	Kopdiameter dk [mm]	Aandrijving	ETA	Artikelnummer	Aantal per verpakking [st.]	Type verpakking	Aantal per omverpakking [st.]	
4,5*	40	35	7,9	PZD-2	●	62050	500	VARIANTA	5.000

* Kleurcode PZD bit =

Uitvoering: Scharnierschroef, platverzonken kop

Aandrijving: Pozi-Drive

Draadtype: voldraad

Materiaal: roestvaststaal A2 1.4567

Oppervlakte: blank, glijcoating

Kleurcode op het HECO-etiket



89

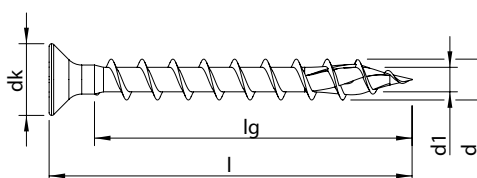

Afmeting d x l [mm]	Draadlengte lg [mm]	Kopdiameter dk [mm]	Aandrijving	ETA	Artikelnummer	Aantal per verpakking [st.]	Type verpakking	Aantal per omverpakking [st.]	
4,5*	40	35	7,9	PZD-2	●	62051	500	VARIANTA	5.000

* Kleurcode PZD bit =

HECO-TOPIX®-plus Glaslatschroef

Productinformatie

- Gereduceerde splijtwerking bij het inschroeven door boorpunt
- Te gebruiken in bijna alle materialen van houtbouw
- Het kleine, iets lenskopvormige ontwerp rondt uw montage optisch af
- Coating zonder chroom-VI
- Goedgekeurd en bewaakt product (CE-markering)



De glaslatschroef voor de professional

Kleine lenskop met freesribben

Voor gemakkelijk en zuiver verzinken van de kop

Schachtribben

Verminderen het inschroefdraaimoment

HECO-TOPIX-plus-punt

Maakt voorboren overbodig en vermindert het risico van splijten van het hout



PerfectPitch®

Optimale schroefdraadspoed voor elke schroeflengte

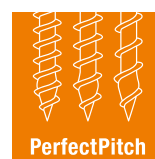

Uitvoering: Glaslatschroef, verzonken lenskop met freesribben

Aandrijving: T-Drive

Draadtype: deeldraad

Materiaal: koolstofstaal

Oppervlakte: verzinkt blauw, A3K **CHROME (VI) FREE +**

Kleurcode op het HECO-etiket

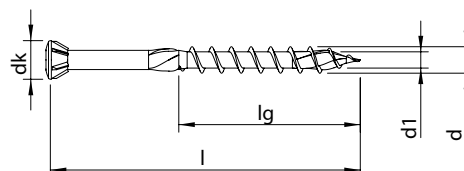

Afmeting d x l [mm]	Draadlengte lg [mm]	Kopdiameter dk [mm]	Aandrijving	ETA	Artikelnummer	Aantal per verpakking [st.]	Type verpakking	Aantal per omverpakking [st.]
3,5 	30	18	5,3	T-10	60249	1.000	VARIANTA	10.000
	35	21	5,3	T-10	60272	1.000	VARIANTA	10.000
	40	27	5,3	T-10	60296	500	VARIANTA	5.000
	50	27	5,3	T-10	60331	500	VARIANTA	5.000
	60	27	5,3	T-10	60349	200	VARIANTA	2.000

Uitvoering: Glaslatschroef, verzonken lenskop met freesribben

Aandrijving: T-Drive

Draadtype: deeldraad

Materiaal: koolstofstaal

Oppervlakte: verzinkt geel, A3L **CHROME (VI) FREE +**

Kleurcode op het HECO-etiket



91

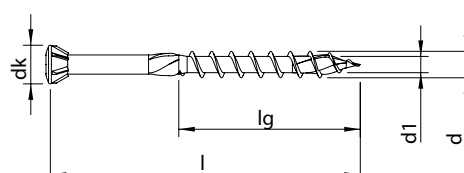

Afmeting d x l [mm]	Draadlengte lg [mm]	Kopdiameter dk [mm]	Aandrijving	ETA	Artikelnummer	Aantal per verpakking [st.]	Type verpakking	Aantal per omverpakking [st.]
3,5 	30	18	5,3	T-10	60250	1.000	VARIANTA	10.000
	35	21	5,3	T-10	60273	1.000	VARIANTA	10.000
	40	27	5,3	T-10	60297	500	VARIANTA	5.000



Uitvoering: Glaslatschroef, verzonken lenskop met freesribben

Aandrijving: T-Drive

Draadtype: deeldraad

Materiaal: roestvaststaal A2 1.4567

Oppervlakte: blank, glijcoating

Kleurcode op het HECO-etiket

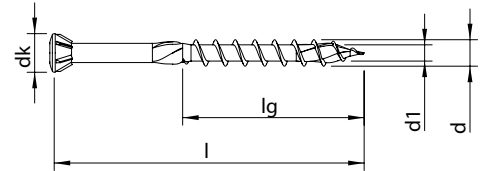

Afmeting d x l [mm]	Draadlengte lg [mm]	Kopdiameter dk [mm]	Aandrijving	ETA	Artikelnummer	Aantal per verpakking [st.]	Type verpakking	Aantal per omverpakking [st.]	
3,5	40	27	5,3	T-10	•	61645	200	SKV	4.000
	50	27	5,3	T-10	•	61652	200	SKV	4.000
	60	27	5,3	T-10	•	61655	200	SKV	4.000

HECO-UFIX MDF-schroef

Productinformatie

- Dicht aan de rand schroeven mogelijk
- Vastschroeven aan kopse kant zonder voorboren
- Vergroot het boorgat door de freesribben op de punt, daardoor wordt de kans op splijtvorming en opbollen vermindert.
- Exact aanzetten zonder weg te glijden op het materiaaloppervlak
- HECO-Drive en aandrijving met GripFit-effect perfect op elkaar afgestemd; de bit wordt vastgeklemd en wankelt niet
- Eén bitmaat voor het complete assortiment

De optimale schroef voor MDF- en HDF-platen

Kleine platverzonken kop met freesholtes

Optimale freeseigenschappen in hout, nauwkeurige bevestiging in het beslag



GripFit®

HECO-Drive maakt werken met één hand mogelijk



▶ Video

Vertande schroefdraad

Vermindering van het inschroefmoment

MDF-boorpunt

Makkelijk en snel voorboren

Freesribben aan de punt

Vermindering van het splijtgedrag bij MDF



Uitvoering: MDF-schroef, platverzonken kop met freesholtes

Aandrijving: HECO-Drive*

Draadtype: deeldraad

Materiaal: koolstofstaal

Oppervlakte: verzinkt blauw, A2K **CHROME (VI) FREE +**

Kleurcode op het HECO-etiket

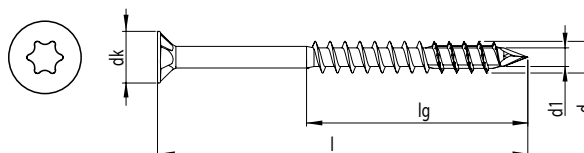

Afmeting d x l [mm]	Draadlengte lg [mm]	Kopdiameter dk [mm]	Aandrijving	ETA	Artikelnummer	Aantal per verpakking [st.]	Type verpakking	Aantal per omverpakking [st.]
3,5 	40	28	7,0	HD-20	47970	200	SKV	4.000
	45	30	7,0	HD-20	47972	200	SKV	4.000
	50	35	7,0	HD-20	47974	200	SKV	4.000
4,0 	40	28	7,4	HD-20	47976	200	SKV	4.000
	45	30	7,4	HD-20	47978	200	SKV	4.000
	50	35	7,4	HD-20	47980	200	SKV	4.000
	60	40	7,4	HD-20	47982	200	VARIANTA	2.000
4,5 	45	30	7,9	HD-20	47984	200	SKV	4.000
	50	35	7,9	HD-20	47986	200	VARIANTA	2.000

* Alle schroeven met HECO-Drive zijn 100% compatibel met conventionele TX-bits.
Het GripFit-effect is alleen gegarandeerd bij gebruik met passende HECO-Drive-bits.

Toepassingsvoorbeelden



Montage van beslag aan kops kant



Stompe corpusverbindingen



Montage van zwenkwielen



Afdekkapjes

Productinformatie

- Plastic afdekkapjes voor schroeven
- Verschillende gangbare RAL-kleuren
- Andere kleuren op aanvraag

Für HECO-platverzonken kopschrauben



Beschrijving: Afdekkapjes voor HECO-schroeven platkop met koptgatboring, PZD, T-Drive en HECO-Drive



Uitvoering	Andrijving	Diameter [mm]	RAL	Kleuren	Artikelnummer	Aantal [st.]	Type verpakking
------------	------------	---------------	-----	---------	---------------	--------------	-----------------

Afdekkapjes voor koptgat							
	2,4 mm	12	1001	beige	19846	500	Plastic zak
	2,4 mm	12	7001	zilvergrijs	19859 NIEUW	500	Plastic zak
	2,4 mm	12	8001	okerbruin	19865	500	Plastic zak
	2,4 mm	12	8007	reebruin	19866	500	Plastic zak
	2,4 mm	12	8011	notenbruin	19868	500	Plastic zak
	2,4 mm	12	8012	roodbruin	19869	500	Plastic zak
	2,4 mm	12	9005	zwart	19872	500	Plastic zak
	2,4 mm	12	9010	wit	19874	500	Plastic zak

Afdekkapjes voor Pozi-Drive							
	PZD-2	12	1001	beige	19885	500	Plastic zak
	PZD-2	12	8001	okerbruin	19914	500	Plastic zak
	PZD-2	12	8007	reebruin	20140	500	Plastic zak
	PZD-2	12	8011	notenbruin	19897	500	Plastic zak
	PZD-2	12	8012	roodbruin	19898	500	Plastic zak
	PZD-2	12	9005	zwart	19899	500	Plastic zak
	PZD-2	12	9010	wit	19900	500	Plastic zak
	PZD-3	12	1001	beige	19902	500	Plastic zak
	PZD-3	12	8001	okerbruin	19907	500	Plastic zak
	PZD-3	12	8007	reebruin	19908	500	Plastic zak
	PZD-3	12	8011	notenbruin	19909	500	Plastic zak
	PZD-3	12	8012	roodbruin	19910	500	Plastic zak
	PZD-3	12	9005	zwart	19911	500	Plastic zak
	PZD-3	12	9010	wit	19913	500	Plastic zak

Afdekkapjes voor T- en HECO-Drive							
	T-/HD-15	12	8011	notenbruin	19925	500	Plastic zak
	T-/HD-15	12	9005	zwart	19921	500	Plastic zak
	T-/HD-15	12	9010	wit	19923	500	Plastic zak
	T-/HD-20	12	8011	notenbruin	48711	500	Plastic zak
	T-/HD-20	12	9005	zwart	48713	500	Plastic zak
	T-/HD-20	12	9010	wit	39844	500	Plastic zak
	T-/HD-25	15	8011	notenbruin	19922	500	Plastic zak
	T-/HD-25	15	9005	zwart	19926	500	Plastic zak
	T-/HD-25	15	9010	wit	19939	500	Plastic zak

* Schroeven met passende koptgatboring op pagina 63

Speciale kleuren: levering vanaf 50.000 stuks mogelijk, RAL-nummer aangeven, prijs op aanvraag



Houtbouwschroeven

SCHROEVEN

HECO-TOPIX-plus, platverzonken kop	102
HECO-TOPIX-plus, cilinderkop	110
HECO-TOPIX-plus, combizeskantkop	112
HECO-TOPIX-plus, tellerkop	114
HECO-TOPIX-plus, tellerkop XL	120
HECO-TOPIX-plus CombiConnect	122
HECO-TOPIX-plus Therm	126
HECO-TOPIX-plus T Solar	128
HECO-TOPIX-plus TCS	130
HECO-TOPIX-plus Paalschroef	132
HECO-TOPIX-plus Verbindingsschroeven	134
HECO-TOPIX-plus Vloerplaatschroef	136
HECO-TOPIX-plus Vloerschroef	138
HECO-TOPIX-plus Gevelschroef	142
HECO-WR Voldraadschroef	144
HECO-WS Zelfborende stalen deugel	146
HECO-WB Draadstang	148
HECO-VB Hout-beton-verbindingsschroef	150
MULTI-MONTI-plus S, zeskantkop, met sluitring	154
MULTI-MONTI-plus F, platverzonken kop	155
MULTI-MONTI-TimberConnect	156
MULTI-MONTI-plus Therm	158

ACCESSOIRES

HECO-PowerLock Houtbouwschroevenhouder	160
Montageaccessoires voor HECO-WS	161
Inschroefhulzen voor HECO-WB	162
Boorsystemen voor HECO-WB	163
Montageaccessoires voor HECO-VB	164
Zetgereedschappen voor MULTI-MONTI-TC	165
HECO-Onderlegschijven	166
HECO-Inschroefhulp	167

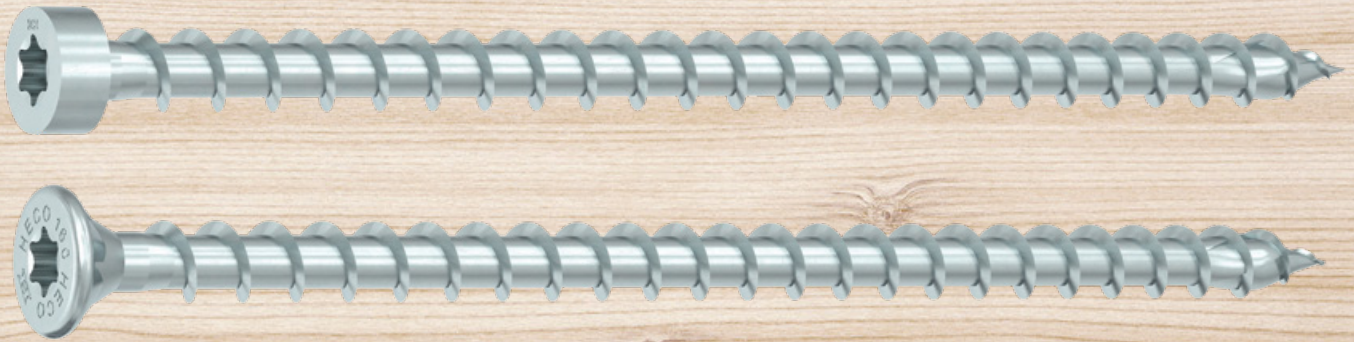

HECO-TOPIX®-plus Houtbouwschroeven

Productinformatie

De innovatieve eigenschappen van HECO-TOPIX-plus leiden ook in de houtbouw tot duidelijke voordelen voor de gebruiker. Dankzij de PerfectPitch kunnen zelfs lange schroeven snel en tijdbesparend worden ingedraaid. Het HECO-Drive systeem met GripFit zorgt ervoor dat de schroef stevig op de bit blijft zitten en maakt het werk gemakkelijker, wat vooral bij roestvrijstalen versies een onovertroffen voordeel is.

Het veelzijdige assortiment biedt zowel flexibel inzetbare, als zeer gespecialiseerde hightech schroeven en dekt een breed scala aan toepassingen in de professionele houtbouw.



Maakt het beste beter.

MagicClose®

Gepatenteerde voldraad trekt houten onderdelen spleetvrij samen zonder voorspannen (alleen voor schroeven met Ø 6mm)



GripFit®

HECO-Drive maakt werken met één hand mogelijk



GripFit

PerfectPitch®

Optimale schroefdraadsped voor elke schroeflengte



PerfectPitch

HECO-TOPIX-plus-punt

Maakt voorbereiden overbodig en vermindert het risico van splijten van het hout



Video





Toepassingsvoorbeelden

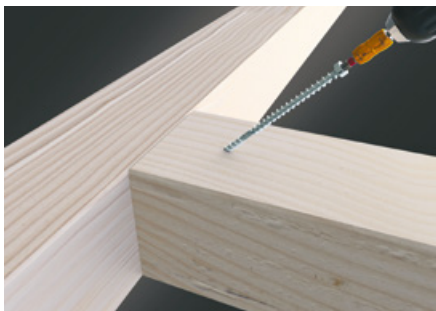

Hoofdhulpligger verbinding

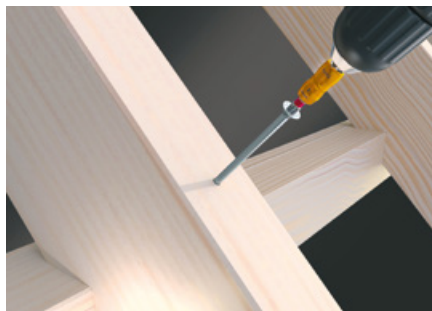

Spantbevestiging



Isolatiemateriaal op dakspanten



Versteviging van doorsnedeverswakkingen

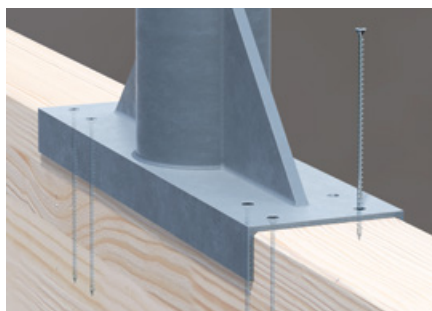

Bevestiging van metalen hulpstukken



Installatie van solar dakhaken



Bevestiging van regelwerk t.b.v. installaties



Uitvoering: platverzonken kop met freesholtes

Aandrijving: HECO-Drive*

Draadtype: variabele voldraad

Materiaal: koolstofstaal

Oppervlakte: verzinkt blauw, A3K **CHROME (VI) FREE +**

Kleurcode op het HECO-etiket

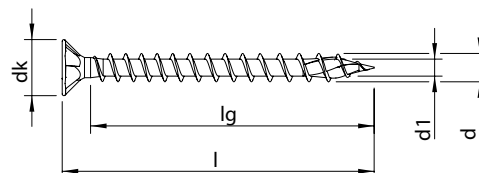

Afmeting d x l [mm]	Draadlengte lg [mm]	Kopdiameter dk [mm]	Aandrijving	ETA	Artikelnummer	Aantal per verpakking [st.]	Type verpakking	Aantal per omverpakking [st.]
6,0	30	23	11,7	HD-30	60996	200	VARIANTA	2.000
	35	28	11,7	HD-30	61002	200	VARIANTA	2.000
	40	33	11,7	HD-30	61006	200	VARIANTA	2.000
	45	38	11,7	HD-30	61020	200	VARIANTA	2.000
	50	43	11,7	HD-30	61028	200	VARIANTA	2.000
	60	53	11,7	HD-30	61051	200	VARIANTA	2.000
	70	63	11,7	HD-30	61072	200	VARIANTA	1.000
	80	73	11,7	HD-30	61084	100	VARIANTA	1.000
	90	83	11,7	HD-30	61098	100	VARIANTA	1.000
	100	93	11,7	HD-30	61107	100	VARIANTA	1.000
	110	103	11,7	HD-30	61121	100	VARIANTA	1.000
	120	113	11,7	HD-30	61128	100	VARIANTA	1.000
	140	133	11,7	HD-30	61144	100	VARIANTA	500
	160	153	11,7	HD-30	61160	100	O-BOX	800

* Alle schroeven met HECO-Drive zijn 100% compatibel met conventionele TX-bits.
Het GripFit-effect is alleen gegarandeerd bij gebruik met bijpassende HECO-Drive-bits.

Uitvoering: **A** platverzonken kop met freesholtes **B** platverzonken kop

Aandrijving: HECO-Drive */T-Drive









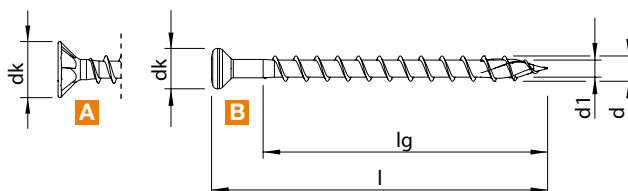
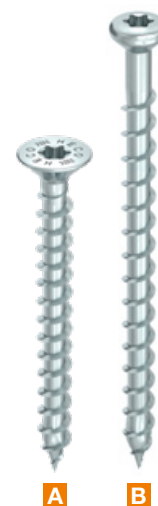













Draadtype: voldraad

Materiaal: koolstofstaal

Oppervlakte: verzinkt blauw, A3K **CHROME (VI) FREE +**

Kleurcode op het HECO-etiket



Afmeting d x l [mm]	Draadlengte lg [mm]	Kopdiameter dk [mm]	Aandrijving	ETA	Artikelnummer	Aantal per verpakking [st.]	Type verpakking	Aantal per omverpakking [st.]	
8,0  A	60	50	14,8	HD-40		61956	100	O-BOX	400
	80	70	14,8	HD-40		61957	100	O-BOX	400
	100	90	14,8	HD-40		61958	100	O-BOX	400
	120	110	14,8	HD-40		61266	100	O-BOX	400
	140	130	14,8	HD-40		63890	100	O-BOX	400
	160	150	14,8	HD-40		61289	100	O-BOX	400
	180	170	14,8	HD-40		61301	100	O-BOX	200
	200	190	14,8	HD-40		61314	100	O-BOX	200
	220	210	14,8	HD-40		61326	50	O-BOX	200
	240	230	14,8	HD-40		61337	50	O-BOX	200
	260	250	14,8	HD-40		61348	50	O-BOX	200
	280	270	14,8	HD-40		61361	50	O-BOX	200
	300	290	14,8	HD-40		61374	50	O-BOX	200
	340	330	14,8	HD-40		61396	50	O-BOX	200
	380	370	14,8	HD-40		61418	50	O-BOX	100
400	370	14,8	HD-40		63352	50	O-BOX	100	
8,0  B	450	415	13,0	T-40		62067 **	50	O-BOX	100
	500	465	13,0	T-40		62068 **	25	O-BOX	100
	550	515	13,0	T-40		62069 **	25	O-BOX	100
	600	565	13,0	T-40		62070 **	25	O-BOX	-

De passende houtbouwschroefhouder HECO-PowerLock vindt u op pagina 160, een inschroefhulp voor hoeken van 45° en 60° op pagina 167.

* Alle schroeven met HECO-Drive zijn 100% compatibel met conventionele TX-bits.
Het GripFit-effect is alleen gegarandeerd bij gebruik met bijpassende HECO-Drive-bits.

** Versie met T-Drive en zonder freesholtes

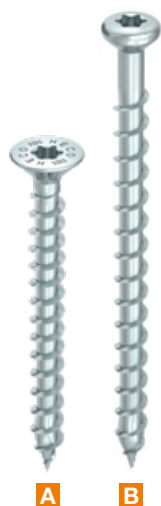

Uitvoering: **A** platverzonken kop met freesholtes **B** platverzonken kop

Aandrijving: HECO-Drive*/T-Drive



Draadtype: voldraad

Materiaal: koolstofstaal

Oppervlakte: verzinkt blauw, A3K **CHROME (VI) FREE +**

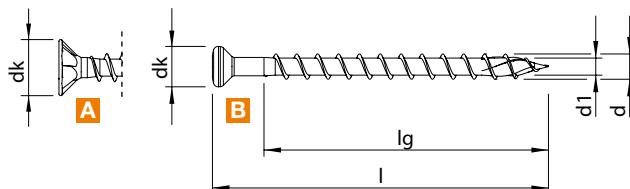
Kleurcode op het HECO-etiket



Afmeting d x l [mm]	Draadlengte lg [mm]	Kopdiameter dk [mm]	Aandrijving	ETA	Artikelnummer	Aantal per verpakking [st.]	Type verpakking	Aantal per omverpakking [st.]	
10,0  A	120	108	18,5	HD-40	•	61488	50	O-BOX	200
	160	148	18,5	HD-40	•	61506	50	O-BOX	200
	200	188	18,5	HD-40	•	61523	50	O-BOX	200
	220	208	18,5	HD-40	•	61532	50	O-BOX	200
	240	228	18,5	HD-40	•	61540	50	O-BOX	100
	260	248	18,5	HD-40	•	61548	50	O-BOX	100
	280	268	18,5	HD-40	•	61557	50	O-BOX	100
	300	288	18,5	HD-40	•	61568	50	O-BOX	100
	340	328	18,5	HD-40	•	61585	50	O-BOX	100
	380	368	18,5	HD-40	•	61596	50	O-BOX	100
	400	368	18,5	HD-40	•	63353	50	O-BOX	100
	10,0  B	450	410	16,5	T-50	•	62084 **	50	O-BOX
500		460	16,5	T-50	•	62085 **	25	O-BOX	50
550		510	16,5	T-50	•	62086 **	25	O-BOX	50
600		560	16,5	T-50	•	62087 **	25	O-BOX	-
700		660	16,5	T-50	•	62088 **	25	O-BOX	-
800		760	16,5	T-50	•	62089 **	25	O-BOX	-

De passende houtbouwschroefhouder HECO-PowerLock vindt u op pagina 160, een inschroefhulp voor hoeken van 45° en 60° op pagina 167.

* Alle schroeven met HECO-Drive zijn 100% compatibel met conventionele TX-bits.

Het GripFit-effect is alleen gegarandeerd bij gebruik met bijpassende HECO-Drive-bits.

** Versie met T-Drive en zonder freesholtes

Uitvoering: platverzonken kop met freesholtes

Aandrijving: HECO-Drive*

Draadtype: variabele voldraad

Materiaal: roestvaststaal A2 1.4567

Oppervlakte: blank, glijcoating

Kleurcode op het HECO-etiket

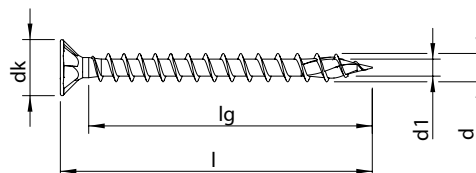

Afmeting d x l [mm]	Draadlengte lg [mm]	Kopdiameter dk [mm]	Aandrijving	ETA	Artikelnummer	Aantal per verpakking [st.]	Type verpakking	Aantal per omverpakking [st.]
6,0	60	53	HD-30	•	62045	200	VARIANTA	2.000
	80	73	HD-30	•	62046	100	VARIANTA	1.000

* Alle schroeven met HECO-Drive zijn 100% compatibel met conventionele TX-bits.
Het GripFit-effect is alleen gegarandeerd bij gebruik met bijpassende HECO-Drive-bits.



Uitvoering: platverzonken kop met freesholtes

Aandrijving: HECO-Drive*

Draadtype: deeldraad

Materiaal: koolstofstaal

Oppervlakte: verzinkt blauw, A3K **CHROME (VI) FREE +**

Kleurcode op het HECO-etiket

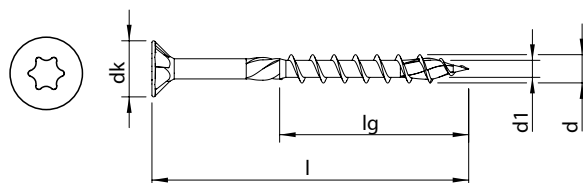

Afmeting d x l [mm]	Draadlengte lg [mm]	Kopdiameter dk [mm]	Aandrijving	ETA	Artikelnummer	Aantal per verpakking [st.]	Type verpakking	Aantal per omverpakking [st.]	
6,0	50	30	11,7	HD-30	●	61033	200	VARIANTA	2.000
★	60	36	11,7	HD-30/HD-25**	●	61056/62260 **	200	VARIANTA	2.000
★	70	42	11,7	HD-30/HD-25**	●	61076/62261 **	200	VARIANTA	1.000
	80	48	11,7	HD-30/HD-25**	●	61088/62262 **	100	VARIANTA	1.000
	90	54	11,7	HD-30/HD-25**	●	61102/62263 **	100	VARIANTA	1.000
	100	60	11,7	HD-30/HD-25**	●	61111/62264 **	100	VARIANTA	1.000
	110	66	11,7	HD-30/HD-25**	●	61124/62265 **	100	VARIANTA	1.000
	120	72	11,7	HD-30/HD-25**	●	61132/62266 **	100	VARIANTA	1.000
	130	72	11,7	HD-30/HD-25**	●	61142/62267 **	100	VARIANTA	1.000
	140	72	11,7	HD-30/HD-25**	●	61147/62268 **	100	VARIANTA	500
	150	72	11,7	HD-30/HD-25**	●	61156/62269 **	100	O-BOX	800
	160	72	11,7	HD-30/HD-25**	●	61163/62270 **	100	O-BOX	800
	180	72	11,7	HD-30/HD-25**	●	61172/62271 **	100	O-BOX	400
	200	72	11,7	HD-30/HD-25**	●	61180/62272 **	100	O-BOX	400
	220	72	11,7	HD-30/HD-25**	●	61187/62273 **	100	O-BOX	400
	240	72	11,7	HD-30/HD-25**	●	61195/62274 **	100	O-BOX	400
	260	72	11,7	HD-30/HD-25**	●	61202/62275 **	100	O-BOX	400
	280	72	11,7	HD-30/HD-25**	●	61209/62276 **	100	O-BOX	400
	300	72	11,7	HD-30/HD-25**	●	61217/62277 **	100	O-BOX	400

* Alle schroeven met HECO-Drive zijn 100% compatibel met conventionele TX-bits.
Het GripFit-effect is alleen gegarandeerd bij gebruik met bijpassende HECO-Drive-bits.

** Alternatieve variant met aandrijving HD-25

Uitvoering: platverzonken kop met freesholtes

Aandrijving: HECO-Drive *

Draadtype: deeldraad

Materiaal: koolstofstaal

Oppervlakte: verzinkt blauw, A3K **CHROME (VI) FREE +**

Kleurcode op het HECO-etiket

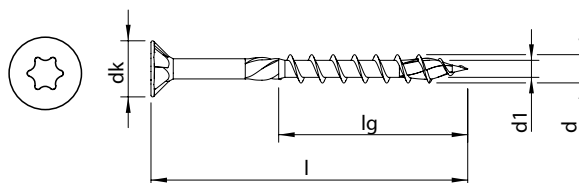

Afmeting d x l [mm]	Draadlengte lg [mm]	Kopdiameter dk [mm]	Aandrijving	ETA	Artikelnummer	Aantal per verpakking [st.]	Type verpakking	Aantal per omverpakking [st.]	
8,0 	80	60	14,8	HD-40	●	61242	100	O-BOX	400
	90	60	14,8	HD-40	●	61251	100	O-BOX	400
	100	60	14,8	HD-40	●	61257	100	O-BOX	400
	120	72	14,8	HD-40	●	61268	100	O-BOX	400
	140	72	14,8	HD-40	●	61277	100	O-BOX	400
	160	100	14,8	HD-40	●	61291	100	O-BOX	400
	180	100	14,8	HD-40	●	61303	100	O-BOX	200
	200	100	14,8	HD-40	●	61315	100	O-BOX	200
	220	100	14,8	HD-40	●	61327	50	O-BOX	200
	240	100	14,8	HD-40	●	61338	50	O-BOX	200
	260	100	14,8	HD-40	●	61349	50	O-BOX	200
	280	100	14,8	HD-40	●	61362	50	O-BOX	200
	300	100	14,8	HD-40	●	61375	50	O-BOX	200
	320	100	14,8	HD-40	●	61385	50	O-BOX	200
	340	100	14,8	HD-40	●	61397	50	O-BOX	200
	360	100	14,8	HD-40	●	61409	50	O-BOX	100
	380	100	14,8	HD-40	●	61419	50	O-BOX	100
	400	100	14,8	HD-40	●	61428	50	O-BOX	100
	420	100	14,8	HD-40	●	61435	50	O-BOX	100
460	100	14,8	HD-40	●	61440	50	O-BOX	100	
500	100	14,8	HD-40	●	61445	50	O-BOX	100	

* Alle schroeven met HECO-Drive zijn 100% compatibel met conventionele TX-bits.
Het GripFit-effect is alleen gegarandeerd bij gebruik met bijpassende HECO-Drive-bits.



Uitvoering: platverzonken kop met freesholtes

Aandrijving: HECO-Drive *

Draadtype: deeldraad

Materiaal: koolstofstaal

Oppervlakte: verzinkt blauw, A3K **CHROME (VI) FREE +**

Kleurcode op het HECO-etiket

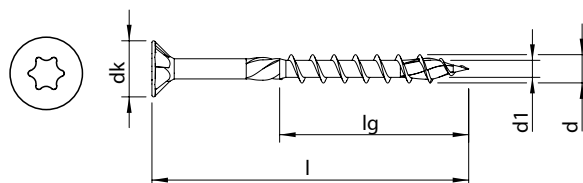

Afmeting d x l [mm]	Draadlengte lg [mm]	Kopdiameter dk [mm]	Aandrijving	ETA	Artikelnummer	Aantal per verpakking [st.]	Type verpakking	Aantal per omverpakking [st.]	
10,0 ★	80	60	18,5	HD-40	●	61473	50	O-BOX	200
	100	84	18,5	HD-40	●	61481	50	O-BOX	200
	120	84	18,5	HD-40	●	61490	50	O-BOX	200
	140	84	18,5	HD-40	●	61499	50	O-BOX	200
	160	100	18,5	HD-40	●	61508	50	O-BOX	200
	180	100	18,5	HD-40	●	61516	50	O-BOX	200
	200	100	18,5	HD-40	●	61524	50	O-BOX	200
	220	100	18,5	HD-40	●	61533	50	O-BOX	200
	240	100	18,5	HD-40	●	61541	50	O-BOX	100
	260	100	18,5	HD-40	●	61549	50	O-BOX	100
	280	100	18,5	HD-40	●	61559	50	O-BOX	100
	300	100	18,5	HD-40	●	61569	50	O-BOX	100
	320	100	18,5	HD-40	●	61577	50	O-BOX	100
	340	100	18,5	HD-40	●	61586	50	O-BOX	100
	360	100	18,5	HD-40	●	61590	50	O-BOX	100
	380	100	18,5	HD-40	●	61597	50	O-BOX	100
	400	100	18,5	HD-40	●	61600	50	O-BOX	100
420	100	18,5	HD-40	●	61607	25	O-BOX	100	
460	100	18,5	HD-40	●	61611	25	O-BOX	100	
500	100	18,5	HD-40	●	61614	25	O-BOX	50	

* Alle schroeven met HECO-Drive zijn 100% compatibel met conventionele TX-bits.
Het GripFit-effect is alleen gegarandeerd bij gebruik met bijpassende HECO-Drive-bits.

Bijpassende onderlegschijven vindt u op pagina 158, een inschroefhulp voor inschroef hoek 60° en 45° op pagina 159



Uitvoering: platverzonken kop met freesholtes

Aandrijving: HECO-Drive *

Draadtype: deeldraad

Materiaal: roestvaststaal A2 1.4567

Oppervlakte: blank, glijcoating

Kleurcode op het HECO-etiket

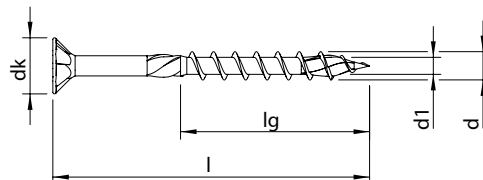

Afmeting d x l [mm]	Draadlengte lg [mm]	Kopdiameter dk [mm]	Aandrijving	ETA	Artikelnummer	Aantal per verpakking [st.]	Type verpakking	Aantal per omverpakking [st.]	
6,0	40	24	11,7	HD-30	●	61801	200	VARIANTA	2.000
	50	30	11,7	HD-30/HD-25**	●	61804/62486**	200	VARIANTA	2.000
	60	36	11,7	HD-30/HD-25**	●	61808/62487**	200	VARIANTA	2.000
	70	42	11,7	HD-30/HD-25**	●	61813/62488**	200	VARIANTA	1.000
	80	48	11,7	HD-30/HD-25**	●	61818/62489**	100	VARIANTA	1.000
	90	54	11,7	HD-30/HD-25**	●	61822/62490**	100	VARIANTA	1.000
	100	60	11,7	HD-30/HD-25**	●	61826/62492**	100	VARIANTA	1.000
	120	72	11,7	HD-30/HD-25**	●	61833/62493**	100	VARIANTA	1.000
	140	72	11,7	HD-30/HD-25**	●	61838/62494**	100	VARIANTA	500
	160	72	11,7	HD-30/HD-25**	●	61840/62495**	100	O-BOX	400
8,0	180	72	11,7	HD-30	●	61842	100	O-BOX	400
	200	72	11,7	HD-30	●	61843	100	O-BOX	400
	80	60	14,8	HD-40	●	61847	100	O-BOX	400
	100	60	14,8	HD-40	●	61851	100	O-BOX	400
	120	72	14,8	HD-40	●	61857	100	O-BOX	400
	140	72	14,8	HD-40	●	61862	100	O-BOX	400
	160	100	14,8	HD-40	●	61866	100	O-BOX	400
	180	100	14,8	HD-40	●	61870	100	O-BOX	200
	200	100	14,8	HD-40	●	61874	100	O-BOX	200
	220	100	14,8	HD-40	●	61879	50	O-BOX	200
	240	100	14,8	HD-40	●	61885	50	O-BOX	200
	260	100	14,8	HD-40	●	61889	50	O-BOX	200
	280	100	14,8	HD-40	●	61894	50	O-BOX	200
	300	100	14,8	HD-40	●	61900	50	O-BOX	200
	320	100	14,8	HD-40	●	61904	50	O-BOX	200
	340	100	14,8	HD-40	●	61905	50	O-BOX	200
	360	100	14,8	HD-40	●	61908	50	O-BOX	100
	380	100	14,8	HD-40	●	61909	50	O-BOX	100
	400	100	14,8	HD-40	●	61910	50	O-BOX	100

* Alle schroeven met HECO-Drive zijn 100% compatibel met conventionele TX-bits.
Het GripFit-effect is alleen gegarandeerd bij gebruik met bijpassende HECO-Drive-bits.

** Alternatieve variant met aandrijving HD-25

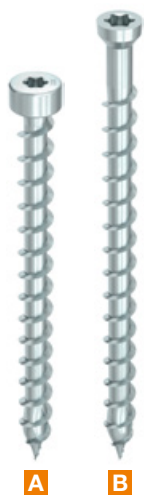

Uitvoering: **A** cilinderkop **B** verzonken cilinderkop

Aandrijving: T-Drive

Draadtype: voldraad

Materiaal: koolstofstaal

Oppervlakte: verzinkt blauw, A3K **CHROME (VI) FREE +**

Kleurcode op het HECO-etiket

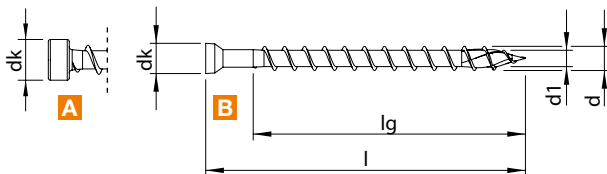

Afmeting d x l [mm]	Draadlengte lg [mm]	Kopdiameter dk [mm]	Aandrijving	ETA	Artikelnummer	Aantal per verpakking [st.]	Type verpakking	Aantal per omverpakking [st.]	
6,0 ★ A	120	114	9,0	T-30	●	61953	100	VARIANTA	1.000
	140	134	9,0	T-30	●	61952	100	VARIANTA	500
	160	154	9,0	T-30	●	61951	100	O-BOX	800
	180	174	9,0	T-30	●	61950	100	O-BOX	400
	200	194	9,0	T-30	●	61949	100	O-BOX	400
8,0 ★ A	120	112	12,0	T-40	●	61928	100	O-BOX	400
	140	132	12,0	T-40	●	64595 NIEUW	100	O-BOX	400
	160	152	12,0	T-40	●	61929	100	O-BOX	400
	180	172	12,0	T-40	●	61930	100	O-BOX	200
	200	192	12,0	T-40	●	61931	100	O-BOX	200
	220	212	12,0	T-40	●	61932	50	O-BOX	200
	240	232	12,0	T-40	●	61933	50	O-BOX	200
	260	252	12,0	T-40	●	61934	50	O-BOX	200
	280	272	12,0	T-40	●	61935	50	O-BOX	200
	300	292	12,0	T-40	●	61936	50	O-BOX	200
	340	332	12,0	T-40	●	61937	50	O-BOX	200
	380	372	12,0	T-40	●	61938	50	O-BOX	100
	400	372	12,0	T-40	●	63649	50	O-BOX	100
8,0 ★ B	450	415	10,0	T-40	●	62079	50	O-BOX	100
	500	465	10,0	T-40	●	62080	25	O-BOX	100
	550	515	10,0	T-40	●	62081	25	O-BOX	100
	600	565	10,0	T-40	●	62082	25	O-BOX	-

De passende houtbouwschroefhouder HECO-PowerLock vindt u op pagina 160, een inschroefhulp voor hoeken van 45° en 60° op pagina 167.

Uitvoering: **A** cilinderkop **B** verzonken cilinderkop

Aandrijving: T-Drive

Draadtype: voldraad

Materiaal: koolstofstaal

Oppervlakte: verzinkt blauw, A3K **CHROME (VI) FREE +** Kleurcode op het HECO-etiket

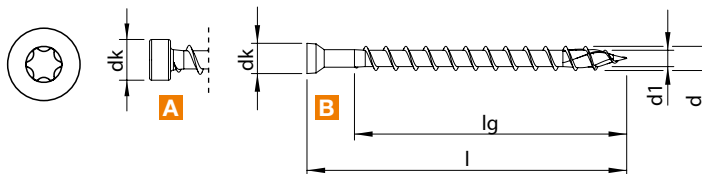

Afmeting d x l [mm]	Draadlengte lg [mm]	Kopdiameter dk [mm]	Aandrijving	ETA	Artikelnummer	Aantal per verpakking [st.]	Type verpakking	Aantal per omverpakking [st.]	
10,0 	120	110	14,0	T-40	•	61939	50	O-BOX	200
	160	150	14,0	T-40	•	61940	50	O-BOX	200
	A 200	190	14,0	T-40	•	61941	50	O-BOX	200
	220	210	14,0	T-40	•	61942	50	O-BOX	200
	240	230	14,0	T-40	•	61943	50	O-BOX	100
	260	250	14,0	T-40	•	61944	50	O-BOX	100
	280	270	14,0	T-40	•	61945	50	O-BOX	100
	300	290	14,0	T-40	•	61946	50	O-BOX	100
	340	330	14,0	T-40	•	61947	50	O-BOX	100
	380	370	14,0	T-40	•	61948	50	O-BOX	100
	400	370	14,0	T-40	•	63650	50	O-BOX	100
	10,0 	450	410	14,0	T-50	•	62072	50	O-BOX
500		460	14,0	T-50	•	62073	25	O-BOX	50
B 550		510	14,0	T-50	•	62074	25	O-BOX	50
600		560	14,0	T-50	•	62075	25	O-BOX	-
700		660	14,0	T-50	•	62076	25	O-BOX	-
800		760	14,0	T-50	•	62077	25	O-BOX	-

De passende houtbouwschroefhouder HECO-PowerLock vindt u op pagina 160, een inschroefhulp voor hoeken van 45° en 60° op pagina 167.



Uitvoering: combizeskantkop

Aandrijving: zeskantkop + T-Drive

Draadtype: voldraad

Materiaal: koolstofstaal

Oppervlakte: verzinkt blauw, A3K **CHROME (VI) FREE +**

Kleurcode op het HECO-etiket

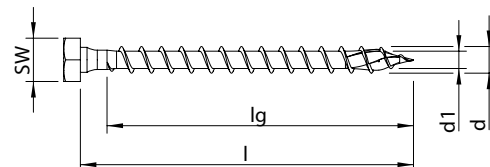

Afmeting d x l [mm]	Draadlengte lg [mm]	Kopdiameter dk [mm]	Aandrijving	ETA	Artikelnummer	Aantal per verpakking [st.]	Type verpakking	Aantal per omverpakking [st.]	
8,0 ★	50	42	13,0	SW-13/T-40	●	61232	100	O-BOX	400
	60	52	13,0	SW-13/T-40	●	61237	100	O-BOX	400
	70	62	13,0	SW-13/T-40	●	61240	50	O-BOX	200
	80	72	13,0	SW-13/T-40	●	61248	50	O-BOX	200
	100	92	13,0	SW-13/T-40	●	61262	50	O-BOX	200
10,0 ★	60	50	15,0	SW-15/T-40	●	61470	50	O-BOX	200
	70	60	15,0	SW-15/T-40	●	61471	50	O-BOX	200
	80	70	15,0	SW-15/T-40	●	61478	50	O-BOX	200
	100	90	15,0	SW-15/T-40	●	61486	50	O-BOX	200

Uitvoering: combizeskantkop

Aandrijving: zeskantkop + T-Drive



Draadtype: deeldraad

Materiaal: koolstofstaal

Oppervlakte: verzinkt blauw, A3K **CHROME (VI) FREE +**

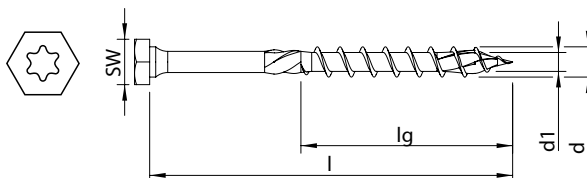
Kleurcode op het HECO-etiket



Afmeting d x l [mm]	Draadlengte lg [mm]	Kopdiameter dk [mm]	Aandrijving	ETA	Artikelnummer	Aantal per verpakking [st.]	Type verpakking	Aantal per omverpakking [st.]	
8,0	120	72	13,0	SW-13/T-40	●	61273	50	O-BOX	200
	140	84	13,0	SW-13/T-40	●	61284	50	O-BOX	200
10,0	120	72	15,0	SW-15/T-40	●	61497	50	O-BOX	200
	140	84	15,0	SW-15/T-40	●	61504	50	O-BOX	200

HECO-TOPIX®-plus Tellerkopschroef

Productinformatie

- Hogere lastoverdracht door vergroot klemvlak van de kop
- Hoge schroefdraadspoed voor sneller inschroeven
- Dimensioneringsbewijzen via HECO-HCS of dimensioneringsservice
- Oppervlakte zonder chroom-VI
- Goedgekeurd en bewaakt product (CE-markering)



De houtbouwschroef voor de professional

Tellerkop

Hogere lastoverdracht door vergroot klemvlak van de kop

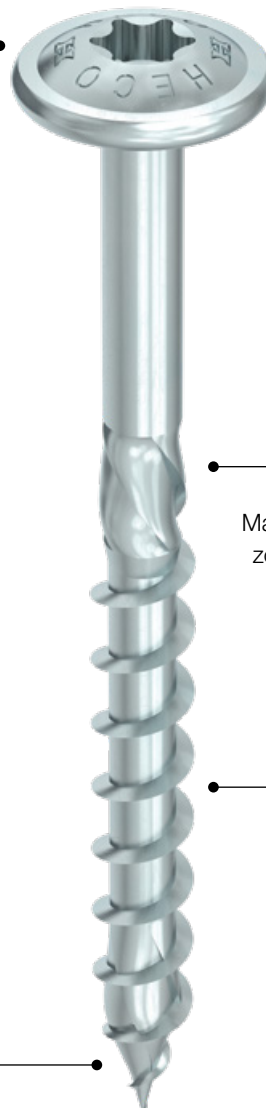

Schachtfreesribben

Maken gemakkelijk inschroeven zonder mechanische spanning mogelijk (alleen bij deeldraad)

PerfectPitch®

Optimale schroefdraadspoed voor elke schroeflengte



HECO-TOPIX-plus-punt

Maakt voorboren overbodig en vermindert het risico van splijten van het hout



Uitvoering: tellerkop

Aandrijving: T-Drive

Draadtype: deeldraad

Materiaal: koolstofstaal

Oppervlakte: verzinkt blauw, A3K **CHROME (VI) FREE +**

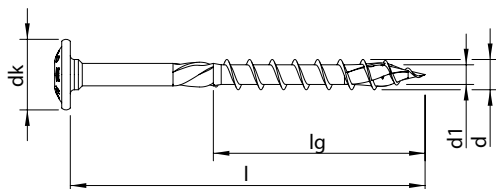

Afmeting d x l [mm]	Draadlengte lg [mm]	Kopdiameter dk [mm]	Aandrijving	ETA	Artikelnummer	Aantal per verpakking [st.]	Type verpakking	Aantal per omverpakking [st.]
6,0	100	60	14,0	T-30 / T-25*	● 61117 / 62278*	100	VARIANTA	1.000
	120	72	14,0	T-30 / T-25*	● 61137 / 62279*	100	VARIANTA	1.000
	140	72	14,0	T-30 / T-25*	● 61151 / 62280*	100	O-BOX	800
	160	72	14,0	T-30 / T-25*	● 61167 / 62281*	100	O-BOX	400
	180	72	14,0	T-30 / T-25*	● 61176 / 62282*	100	O-BOX	400
	200	72	14,0	T-30 / T-25*	● 61185 / 62283*	100	O-BOX	400
	220	72	14,0	T-30 / T-25*	● 61192 / 62284*	100	O-BOX	400
	240	72	14,0	T-30 / T-25*	● 61199 / 62285*	100	O-BOX	400
	260	72	14,0	T-30 / T-25*	● 61206 / 62286*	100	O-BOX	400
	280	72	14,0	T-30 / T-25*	● 61213 / 62287*	100	O-BOX	400
	300	72	14,0	T-30 / T-25*	● 61220 / 62288*	100	O-BOX	200
8,0	120	72	18,0	T-40	● 61272	50	O-BOX	200
	140	100	18,0	T-40	● 61280	50	O-BOX	200
	160	100	18,0	T-40	● 61294	50	O-BOX	200
	180	100	18,0	T-40	● 61306	50	O-BOX	200
	200	100	18,0	T-40	● 61319	50	O-BOX	200
	220	100	18,0	T-40	● 61330	50	O-BOX	200
	240	100	18,0	T-40	● 61341	50	O-BOX	200
	260	100	18,0	T-40	● 61353	50	O-BOX	200
	280	100	18,0	T-40	● 61367	50	O-BOX	200
	300	100	18,0	T-40	● 61379	50	O-BOX	200
	320	100	18,0	T-40	● 61391	50	O-BOX	200
	340	100	18,0	T-40	● 61403	50	O-BOX	100
	360	100	18,0	T-40	● 61413	50	O-BOX	100
	380	100	18,0	T-40	● 61423	50	O-BOX	100
	400	100	18,0	T-40	● 61432	50	O-BOX	100
	420	100	18,0	T-40	● 61438	50	O-BOX	100
460	100	18,0	T-40	● 61443	50	O-BOX	100	
500	100	18,0	T-40	● 61447	50	O-BOX	100	

* Alternatieve variant met aandrijving T-25



Uitvoering:	tellerkop
Aandrijving:	T-Drive
Draadtype:	deeldraad
Materiaal:	koolstofstaal
Oppervlakte:	verzinkt blauw, A3K CHROME (VI) FREE +

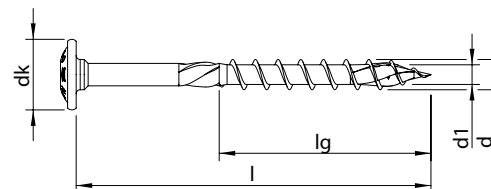

Afmeting d x l [mm]	Draadlengte lg [mm]	Kopdiameter dk [mm]	Aandrijving	ETA	Artikelnummer	Aantal per verpakking [st.]	Type verpakking	Aantal per omverpakking [st.]	
10,0 ★	140	84	22,5	T-40	●	61501	50	O-BOX	200
	160	100	22,5	T-40	●	61512	50	O-BOX	200
	180	100	22,5	T-40	●	61518	50	O-BOX	200
	200	100	22,5	T-40	●	61527	50	O-BOX	200
	220	100	22,5	T-40	●	61535	50	O-BOX	200
	240	100	22,5	T-40	●	61543	50	O-BOX	100
	260	100	22,5	T-40	●	61552	50	O-BOX	100
	280	100	22,5	T-40	●	61562	50	O-BOX	100
	300	100	22,5	T-40	●	61572	50	O-BOX	100
	320	100	22,5	T-40	●	61580	50	O-BOX	100
	340	100	22,5	T-40	●	61588	50	O-BOX	100
	360	100	22,5	T-40	●	61592	50	O-BOX	100
	380	100	22,5	T-40	●	61598	50	O-BOX	100
	400	100	22,5	T-40	●	61603	50	O-BOX	100

Uitvoering: tellerkop

Aandrijving: T-Drive

Draadtype: deeldraad

Materiaal: roestvaststaal A2 1.4567

Oppervlakte: blank, glijcoating

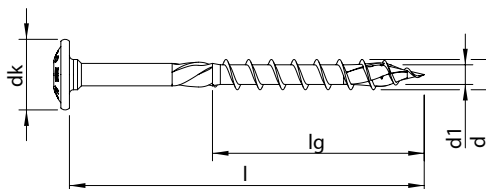

Afmeting d x l [mm]	Draadlengte lg [mm]	Kopdiameter dk [mm]	Aandrijving	ETA	Artikelnummer	Aantal per verpakking [st.]	Type verpakking	Aantal per omverpakking [st.]	
6,0 	100	60	14,0	T-30	●	61828	100	VARIANTA	1.000
	120	72	14,0	T-30	●	61836	100	VARIANTA	500
8,0 	140	100	18,0	T-40	●	61863	50	O-BOX	200
	160	100	18,0	T-40	●	61868	50	O-BOX	200
	180	100	18,0	T-40	●	61872	50	O-BOX	200
	200	100	18,0	T-40	●	61876	50	O-BOX	200
	220	100	18,0	T-40	●	61880	50	O-BOX	200
	240	100	18,0	T-40	●	61887	50	O-BOX	200
	260	100	18,0	T-40	●	61891	50	O-BOX	200
	280	100	18,0	T-40	●	61896	50	O-BOX	200
300	100	18,0	T-40	●	61902	50	O-BOX	200	



Uitvoering: tellerkop

Aandrijving: T-Drive

Draadtype: variabele voldraad

Materiaal: koolstofstaal

Oppervlakte: verzinkt blauw, A3K **CHROME (VI) FREE +**

Kleurcode op het HECO-etiket

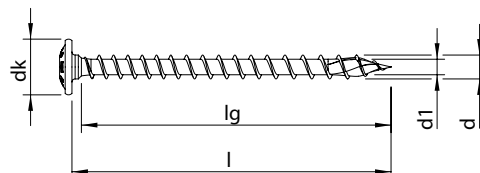

Afmeting d x l [mm]	Draadlengte lg [mm]	Kopdiameter dk [mm]	Aandrijving	ETA	Artikelnummer	Aantal per verpakking [st.]	Type verpakking	Aantal per omverpakking [st.]	
6,0 ★	40	36	14,0	T-30	●	61013	200	VARIANTA	2.000
	50	46	14,0	T-30	●	61039	200	VARIANTA	2.000
	60	56	14,0	T-30	●	61063	100	VARIANTA	1.000
	70	66	14,0	T-30	●	61080	100	VARIANTA	1.000
	80	76	14,0	T-30	●	61094	100	VARIANTA	1.000



Uitvoering: tellerkop

Aandrijving: T-Drive

Draadtype: voldraad

Materiaal: koolstofstaal

Oppervlakte: verzinkt blauw, A3K **CHROME (VI) FREE +**

Kleurcode op het HECO-etiket

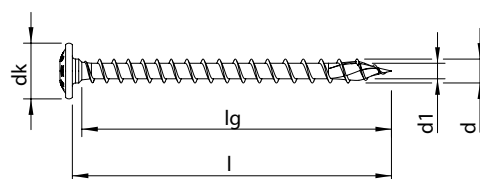

Afmeting d x l [mm]	Draadlengte lg [mm]	Kopdiameter dk [mm]	Aandrijving	ETA	Artikelnummer	Aantal per verpakking [st.]	Type verpakking	Aantal per omverpakking [st.]	
8,0 ★	80	74	18,0	T-40	●	61245	50	O-BOX	200
	100	94	18,0	T-40	●	61259	50	O-BOX	200
	120	114	18,0	T-40	●	61270	50	O-BOX	200
10,0 ★	80	73	22,5	T-40	●	61475	50	O-BOX	200
	100	93	22,5	T-40	●	61483	50	O-BOX	200
	120	100	22,5	T-40	●	61492	50	O-BOX	200

Uitvoering: tellerkop

Aandrijving: T-Drive

Draadtype: variabele voldraad

Materiaal: roestvaststaal A2 1.4567

Oppervlakte: blank, glijcoating

Kleurcode op het HECO-etiket

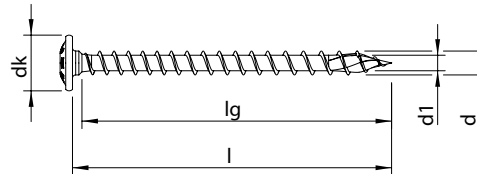

Afmeting d x l [mm]	Draadlengte lg [mm]	Kopdiameter dk [mm]	Aandrijving	ETA	Artikelnummer	Aantal per verpakking [st.]	Type verpakking	Aantal per omverpakking [st.]	
6,0 	40	36	14,0	T-30	●	61802	200	VARIANTA	2.000
	50	46	14,0	T-30	●	61805	200	VARIANTA	2.000
	60	56	14,0	T-30	●	61810	100	VARIANTA	1.000
	70	66	14,0	T-30	●	61815	100	VARIANTA	1.000
	80	76	14,0	T-30	●	61820	100	VARIANTA	1.000

Uitvoering: tellerkop

Aandrijving: T-Drive

Draadtype: voldraad

Materiaal: roestvaststaal A2 1.4567

Oppervlakte: blank, glijcoating

Kleurcode op het HECO-etiket

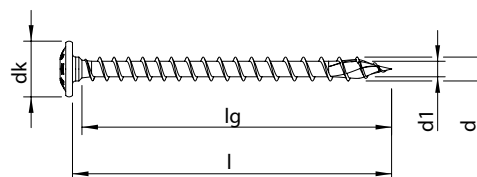

Afmeting d x l [mm]	Draadlengte lg [mm]	Kopdiameter dk [mm]	Aandrijving	ETA	Artikelnummer	Aantal per verpakking [st.]	Type verpakking	Aantal per omverpakking [st.]	
8,0 	40	34	18,0	T-40	●	61844	50	O-BOX	200
	50	44	18,0	T-40	●	61845	50	O-BOX	200
	60	54	18,0	T-40	●	61846	50	O-BOX	200
	80	74	18,0	T-40	●	61849	50	O-BOX	200
	100	94	18,0	T-40	●	61853	50	O-BOX	200
	120	114	18,0	T-40	●	61860	50	O-BOX	200



Uitvoering: tellerkop XL

Aandrijving: T-Drive

Draadtype: deeldraad

Materiaal: koolstofstaal

Oppervlakte: verzinkt blauw, A3K **CHROME (VI) FREE +**

Kleurcode op het HECO-etiket

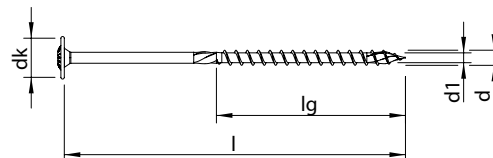

Afmeting d x l [mm]	Draadlengte lg [mm]	Kopdiameter dk [mm]	Aandrijving	ETA	Artikelnummer	Aantal per verpakking [st.]	Type verpakking	Aantal per omverpakking [st.]	
8,0 	160	100	22,5	T-40	•	61293	50	O-BOX	200
	180	100	22,5	T-40	•	61305	50	O-BOX	200
	200	100	22,5	T-40	•	61317	50	O-BOX	200
	220	100	22,5	T-40	•	61329	50	O-BOX	200
	240	100	22,5	T-40	•	61340	50	O-BOX	200
	260	100	22,5	T-40	•	61351	50	O-BOX	200
	280	100	22,5	T-40	•	61365	50	O-BOX	200
	300	100	22,5	T-40	•	61378	50	O-BOX	200
	320	100	22,5	T-40	•	61389	50	O-BOX	100
	340	100	22,5	T-40	•	61402	50	O-BOX	100
	360	100	22,5	T-40	•	61412	50	O-BOX	100
	380	100	22,5	T-40	•	61422	50	O-BOX	100
	400	100	22,5	T-40	•	61431	50	O-BOX	100

HECO-TOPIX®-plus CombiConnect

Productinformatie

- Overdracht van hoge trek- en drukkrachten via de CC-schroefdraad
- Trekt tijdens het schroeven de te verbinden onderdelen samen
- Universele toepassingsmogelijkheden voor nieuwbouw en renovatiewerkzaamheden
- Eenvoudig verzinken in hout
- Dimensioneringsbewijzen via HECO-dimensioneringssoftware HCS of dimensioneringsservice
- Goedgekeurd en bewaakt product (CE-markering)



De power-schroef met opnamemogelijkheid van hoge trekbelastingen

Cilinderkop

Voor splijtvrij inschroeven van de schroefkop, ook bij kleine schroefafstanden onzichtbare montage is mogelijk

PerfectPitch®

Optimale schroefdraadspoed voor elke schroeflengte

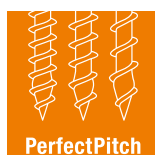

Klemeffect

Door verschillende soorten schroefdraadspoed

HECO-TOPIX-plus-punt

Maakt voorboren overbodig en vermindert het risico van splijten van het hout





Toepassingsvoorbeelden



Stompe dwarsverbinding



Paal/ligger verbinding



Korbeel (schoor) verbinding

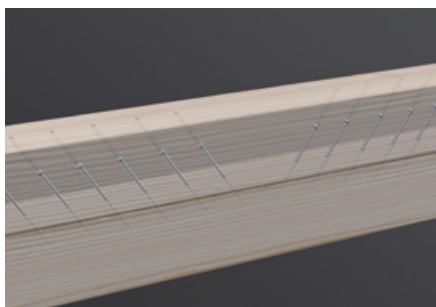

Versterking van spanten/verdubbeling



Kruisverbinding

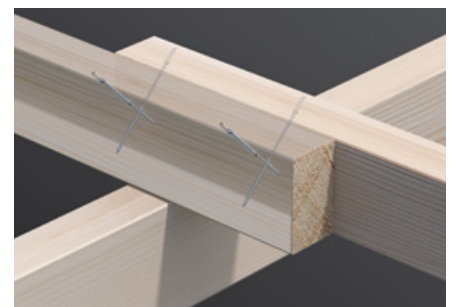

Koppelde kruisverbinding

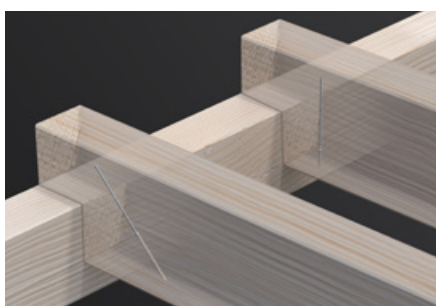

Inkeping



Uitvoering: HECO-TOPIX-plus CombiConnect, cilinderkop

Aandrijving: T-Drive

Draadtype: CC-draad

Materiaal: koolstofstaal

Oppervlakte: verzinkt blauw, A3K **CHROME (VI) FREE +**

Kleurcode op het HECO-etiket

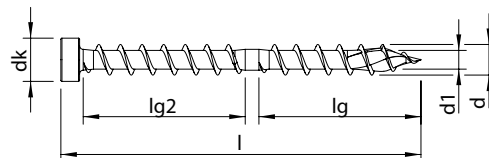

Afmeting d x l [mm]	Draadlengte lg [mm]	Kopdiameter dk [mm]	Aandrijving	ETA	Artikelnummer	Aantal per verpakking [st.]	Type verpakking	Aantal per omverpakking [st.]	
6,5 	100	45/45	9,0	T-30	●	61222	100	VARIANTA	1.000
	130	60/60	9,0	T-30	●	61224	100	VARIANTA	1.000
	150	70/70	9,0	T-30	●	61225	100	O-BOX	400
	190	90/90	9,0	T-30	●	61226	100	O-BOX	400
	215	100/100	9,0	T-30	●	61227	100	O-BOX	400
8,5 	100	45/45	12,0	T-40	●	61448	100	O-BOX	400
	150	70/70	12,0	T-40	●	61449	100	O-BOX	400
	190	90/90	12,0	T-40	●	61452	100	O-BOX	200
	215	100/100	12,0	T-40	●	61455	50	O-BOX	200
	250	110/110	12,0	T-40	●	61457	50	O-BOX	200
	270	122/122	12,0	T-40	●	61459	50	O-BOX	200
	300	138/138	12,0	T-40	●	61461	50	O-BOX	200
	350	158/158	12,0	T-40	●	61463	50	O-BOX	100
	400	182/182	12,0	T-40	●	61466	50	O-BOX	100

Inschreefhulp voor inschroef hoek 60° en 45° op pagina 167

HECO-HCS 4.0 Dimensioneringssoftware

Berekeningen met HECO-TOPIX-plus CombiConnect en vele anderen HECO-schroeven!



Productinformatie

Berekeningsinstrumenten

- hoofd/hulpligger aansluitingen
- opdikkingen
- afschuif versterkingen bij doorbreken en
- inkepingen
- balkhoofdvernieuwingen
- steunpuntversterkingen
- laterale draagversterkingen
- wandaansluitingen, etc.

Meer informatie?

De uitvoerige beschrijving voor de berekeningssoftware HCS vindt u op pagina 8 van deze catalogus.

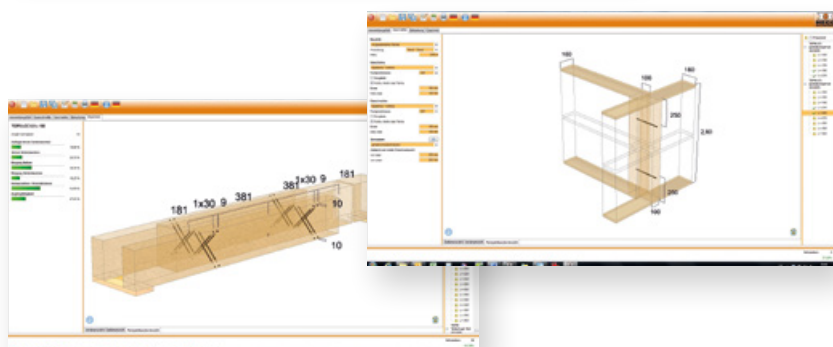



HECO-TOPIX®-plus Therm

Productinformatie

- Drukkrachten worden door de onderkopdraad direct naar de spanten geleid
- Hogere lastopnames door de onderkopdraad
- Te gebruiken voor gangbare isolatiematerialen
- Dimensioneringsbewijzen via HECO-dimensioneringssoftware HCS of dimensioneringsservice
- Goedgekeurd en bewaakt product (CE-markering)



De houtschroef voor dakspanten met drukzachte isolatiematerialen

Platverzonken kop met freesholtes

Voor een eenvoudig verzinken in hout

Onderkopdraad

Leidt drukkrachten direct naar de spanten

HECO-TOPIX-plus-punt

Maakt voorboren overbodig en vermindert het risico van splijten van het hout

GripFit®

HECO-Drive maakt werken met één hand mogelijk



PerfectPitch®

Optimale schroefdraadspoed voor elke schroeflengte



Uitvoering: HECO-TOPIX-plus Therm, platverzonken kop met freesholtes

Aandrijving: HECO-Drive *

Draadtype: onderkopdraad

Materiaal: koolstofstaal

Oppervlakte: verzinkt blauw, A3K **CHROME (VI) FREE +** Kleurcode op het HECO-etiket

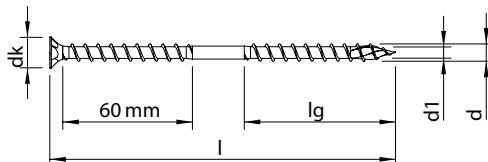

Afmeting d x l [mm]	Draadlengte lg [mm]	Kopdiameter dk [mm]	Aandrijving	ETA	Artikelnummer	Aantal per verpakking [st.]	Type verpakking	Aantal per omverpakking [st.]	
8,0 	160	70	14,8	HD-40	•	61286	50	O-BOX	200
	200	70	14,8	HD-40	•	61310	50	O-BOX	200
	240	100	14,8	HD-40	•	61333	50	O-BOX	200
	280	100	14,8	HD-40	•	61357	50	O-BOX	200
	300	100	14,8	HD-40	•	61370	50	O-BOX	200
	330	100	14,8	HD-40	•	61394	50	O-BOX	100
	360	100	14,8	HD-40	•	61406	50	O-BOX	100
	400	100	14,8	HD-40	•	61427	50	O-BOX	100
	450	100	14,8	HD-40	•	61439	50	O-BOX	100
	500	100	14,8	HD-40	•	61444	50	O-BOX	100
	550	100	14,8	HD-40	•	61954	50	O-BOX	200
600	100	14,8	HD-40	•	61955	50	O-BOX	-	
10,0 	380	100	18,5	HD-40	•	61595	50	O-BOX	100
	420	100	18,5	HD-40	•	61606	25	O-BOX	100
	460	100	18,5	HD-40	•	61610	25	O-BOX	100

* Alle schroeven met HECO-Drive zijn 100% compatibel met conventionele TX-bits.
Het GripFit-effect is alleen gegarandeerd bij gebruik met bijpassende HECO-Drive-bits.

Inschroefhulp voor inschroef hoek 60° en 45° op pagina 167



Productinformatie

- Inzetbaar voor de montage van haken voor zonnepanelen bij daken met isolatiemateriaal op dakspanten
- Fixatie van tengel via een schroef met onderkopdraad
- Tellerkop voor een optimale fixatie van het beslag op hout
- Roestvaststaal A2 1.4567
- Goedgekeurd en bewaakt product (CE-markering)



De houtschroef voor montage van zonnepanelen bij daken met isolatiemateriaal op dakspanten

Tellerkop

Voor een optimale fixatie van het beslag op hout

Onderkopdraad

Voor het fixatie van de tengel

HECO-TOPIX-plus-punt

Maakt voorboren overbodig en vermindert het risico van splijten van het hout



PerfectPitch®

Optimale schroefdraadspoed voor elke schroeflengte

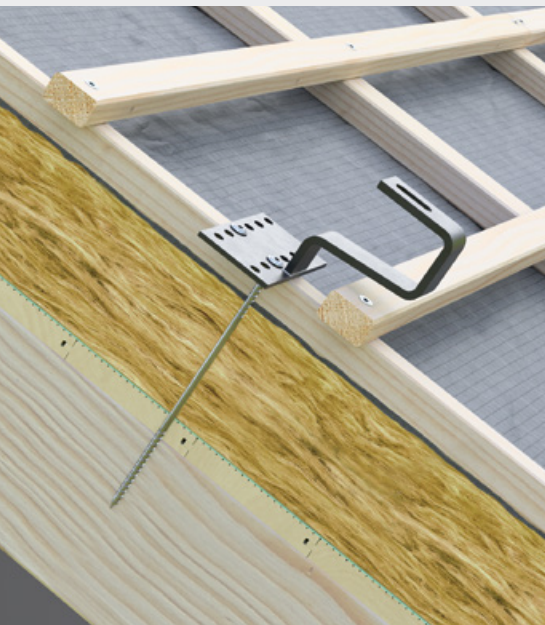

Uitvoering: HECO-TOPIX-plus T Solar, tellerkop

Aandrijving: T-Drive

Draadtype: onderkopdraad

Materiaal: roestvaststaal A2 1.4567

Oppervlakte: blank, glijcoating

Kleurcode op het HECO-etiket

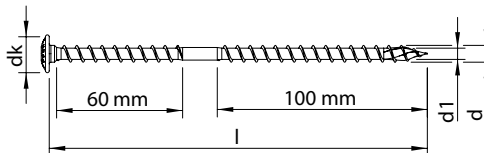

Afmeting d x l [mm]	Draadlengte lg [mm]	Kopdiameter dk [mm]	Aandrijving	ETA	Artikelnummer	Aantal per verpakking [st.]	Type verpakking	Aantal per omverpakking [st.]	
8,0	180	72	18,0	T-40	•	63374	50	O-BOX	200
	240	100	18,0	T-40	•	61882	50	O-BOX	200
	300	100	18,0	T-40	•	61897	50	O-BOX	200
	360	100	18,0	T-40	•	61907	50	O-BOX	100



HECO-TOPIX®-plus TCS

Productinformatie

- Aandrijving: HD-30 (analoog aan HT-plus Ø 6,0). Daarom is er geen bitwisseling nodig.
- Hoge krachtoverbrenging, ook onder de moeilijkste omstandigheden
- HECO-Drive en aandrijving met GripFit-effect perfect op elkaar afgestemd
- Oppervlakte zonder chroom-VI
- Goedgekeurd en bewaakt product (CE-markering)



Voor minder bitwisselingen in houtbouw

Aandrijving HD-30

Voor overdracht met hoog vermogen en minder bitwisselingen

GripFit®

HECO-Drive maakt werken met één hand mogelijk



MagicClose®

Gepatenteerde voldraad trekt houten onderdelen spleetvrij samen zonder voorspannen (alleen bij voldraad)

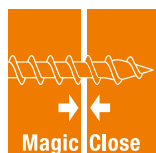

PerfectPitch®

Optimale schroefdraadspoed voor elke schroeflengte



HECO-TOPIX-plus-punt

Maakt voorboren overbodig en vermindert het risico van splijten van het hout



Uitvoering: platverzonken kop 60° met freesribben

Aandrijving: HECO-Drive*

Draadtype: variabele voldraad

Materiaal: koolstofstaal

Oppervlakte: verzinkt blauw, A3K **CHROME (VI) FREE +**

Kleurcode op het HECO-etiket

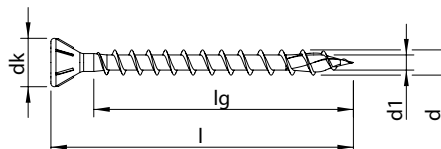

Afmeting d x l [mm]	Draadlengte lg [mm]	Kopdiameter dk [mm]	Aandrijving	ETA	Artikelnummer	Aantal per verpakking [st.]	Type verpakking	Aantal per omverpakking [st.]	
5,0 ★	40	32	9,6	HD-30	●	62097	500	VARIANTA	5.000
	50	42	9,6	HD-30	●	62098	200	VARIANTA	2.000
	60	52	9,6	HD-30	●	62099	200	VARIANTA	2.000
	80	72	9,6	HD-30	●	62100	200	VARIANTA	2.000
	100	92	9,6	HD-30	●	62101	100	VARIANTA	1.000
	120	112	9,6	HD-30	●	62102	100	VARIANTA	1.000

* Alle schroeven met HECO-Drive zijn 100% compatibel met conventionele TX-bits.
Het GripFit-effect is alleen gegarandeerd bij gebruik met bijpassende HECO-Drive-bits.

Uitvoering: platverzonken kop 60° met freesribben

Aandrijving: HECO-Drive*

Draadtype: deeldraad

Materiaal: koolstofstaal

Oppervlakte: verzinkt blauw, A3K **CHROME (VI) FREE +**

Kleurcode op het HECO-etiket

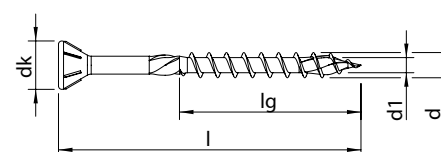

Afmeting d x l [mm]	Draadlengte lg [mm]	Kopdiameter dk [mm]	Aandrijving	ETA	Artikelnummer	Aantal per verpakking [st.]	Type verpakking	Aantal per omverpakking [st.]	
5,0 ★	40	24	9,6	HD-30	●	62091	500	VARIANTA	5.000
	50	30	9,6	HD-30	●	62092	200	VARIANTA	2.000
	60	36	9,6	HD-30	●	62093	200	VARIANTA	2.000
	80	48	9,6	HD-30	●	62094	200	VARIANTA	2.000
	100	60	9,6	HD-30	●	62095	100	VARIANTA	1.000
	120	60	9,6	HD-30	●	62096	100	VARIANTA	1.000

* Alle schroeven met HECO-Drive zijn 100% compatibel met conventionele TX-bits.
Het GripFit-effect is alleen gegarandeerd bij gebruik met bijpassende HECO-Drive-bits.



HECO-TOPIX®-plus Paalschroef

Productinformatie

- Voor het bevestigen van houten palen in paalsteunen, kolomvoeten, grondankers, enz.
- Bevestiging van montage hulpstukken zoals schoren of stalen steunen
- Verbeterde corrosiebescherming door HP-coating
- Tellerkop met onder de kop een verdikte schacht; goede centreringen vlakke aansluiting van de kop op het beslag
- Snelle verwerking zonder voorboren
- Dimensioneringsbewijzen via HECO-HCS of dimensionerings-service
- Goedgekeurd en bewaakt product (CE-markering)



De ideale schroef voor gebruik in houtverbinders buiten

Tellerkop

Hogere lastoverdracht door vergroot klemvlak van de kop

MagicClose®

Gepatenteerde voldraad trekt houten onderdelen spleetvrij samen zonder voorspannen (alleen bij Ø6 mm)

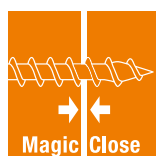

HECO-TOPIX-plus-punt

Maakt voorboren overbodig en vermindert het risico van splijten van het hout

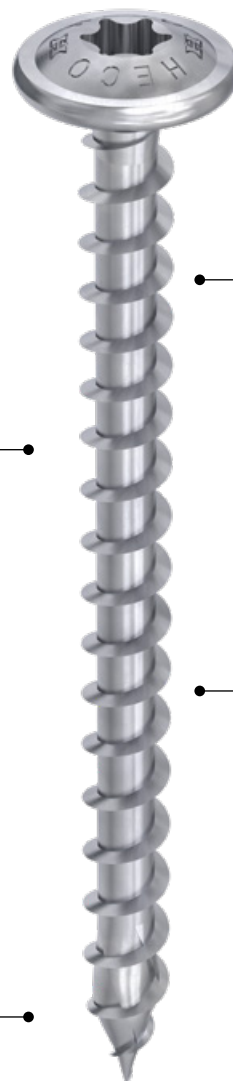

PerfectPitch®

Optimale schroefdraadspoed voor elke schroeflengte



PerfectPitch

HP-coating

Voor verbeterde corrosiebescherming



Uitvoering: Paalschroef, tellerkop

Aandrijving: T-Drive

Draadtype: variabele voldraad

Materiaal: koolstofstaal

Oppervlakte: HP-coating **CHROME (VI) FREE +**

Kleurcode op het HECO-etiket

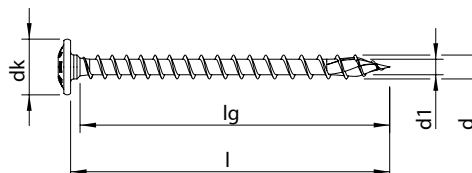

Afmeting d x l [mm]	Draadlengte lg [mm]	Kopdiameter dk [mm]	Aandrijving	ETA	Artikelnummer	Aantal per verpakking [st.]	Type verpakking	Aantal per omverpakking [st.]	
6,0	40	36	14,0	T-30	•	61016	200	VARIANTA	2.000
	50	46	14,0	T-30	•	61041	200	VARIANTA	2.000
	60	56	14,0	T-30	•	61067	100	VARIANTA	1.000

HECO-TOPIX-plus tellerkopschroeven in roestvrijstaal A2 vindt u op pagina 117 en 119

Uitvoering: Paalschroef, tellerkop

Aandrijving: T-Drive

Draadtype: voldraad

Materiaal: koolstofstaal

Oppervlakte: HP-coating **CHROME (VI) FREE +**

Kleurcode op het HECO-etiket

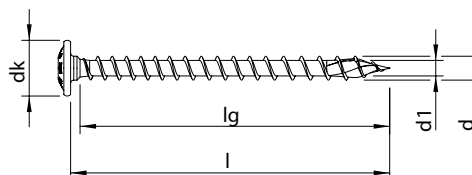

Afmeting d x l [mm]	Draadlengte lg [mm]	Kopdiameter dk [mm]	Aandrijving	ETA	Artikelnummer	Aantal per verpakking [st.]	Type verpakking	Aantal per omverpakking [st.]	
8,0	40	34	18,0	T-40	•	61228	100	O-BOX	400
	50	44	18,0	T-40	•	61230	100	O-BOX	400
	60	54	18,0	T-40	•	61234	100	O-BOX	400

HECO-TOPIX-plus tellerkopschroeven in roestvrijstaal A2 vindt u op pagina 117 en 119

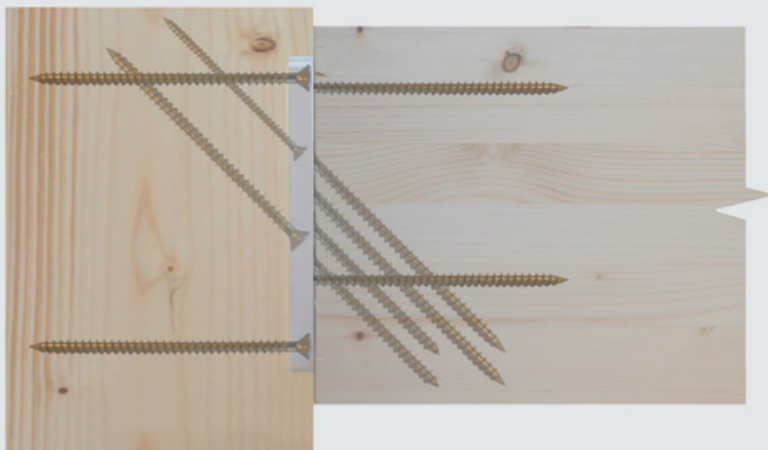

HECO-TOPIX®-plus Verbindingschroeven

Productinformatie

Algemeen

- Afgestemde schroefdraad-lengten voor optimaal gebruik van houtverbinders
- Verminderde rand- en asafstanden
- Onderdeel van de dimensionerings software van Pitzl
- Ook inzetbaar voor andere veldraadoplossingen
- Goedgekeurd en bewaakt product (CE-markering)

Tellerkop

- Hogere lastoverdracht door vergroot klemvlak van de kop
- Vlak aandrukken van de verbinder
- Verdikte schacht voor een betere centering van de houtverbinder

Platverzonken kop

- Geen beschadiging van het oppervlak bij metalen beslag



De ideale schroef voor gebruik in houtverbinders

Tellerkop



Platverzonken kop met freesholtes



GripFit®

HECO-Drive maakt werken met één hand mogelijk



PerfectPitch®

Optimale schroefdraadspoed voor elke schroeflengte



HECO-TOPIX-plus-punt

Maakt voorboren overbodig en vermindert het risico van splijten van het hout

Uitvoering: Verbindingschroef, tellerkop

Aandrijving: T-Drive

Draadtype: voldraad

Materiaal: koolstofstaal

Oppervlakte: verzinkt blauw, A3K **CHROME (VI) FREE +**

Kleurcode op het HECO-etiket

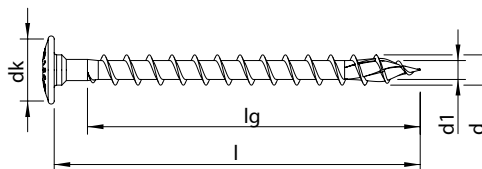
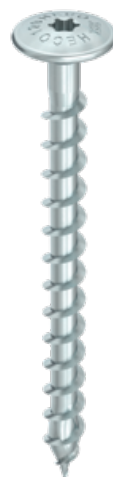

Afmeting d x l [mm]	Draadlengte lg [mm]	Kopdiameter dk [mm]	Aandrijving	ETA	Artikelnummer	Aantal per verpakking [st.]	Type verpakking	Aantal per omverpakking [st.]	
10,0	120	110	22,5	T-40	●	61495	50	O-BOX	200
	160	150	22,5	T-40	●	61510	50	O-BOX	200

Uitvoering: Verbindingschroef, platverzonken kop met freesholtes

Aandrijving: HECO-Drive *

Draadtype: voldraad

Materiaal: koolstofstaal

Oppervlakte: verzinkt blauw, A3K **CHROME (VI) FREE +**

Kleurcode op het HECO-etiket

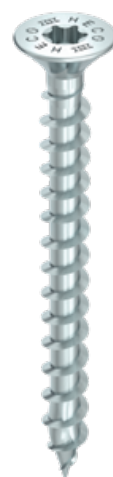

135

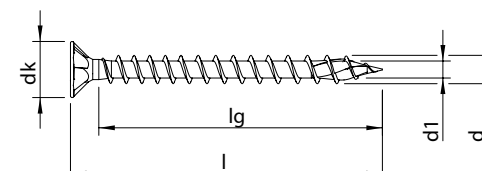

Afmeting d x l [mm]	Draadlengte lg [mm]	Kopdiameter dk [mm]	Aandrijving	ETA	Artikelnummer	Aantal per verpakking [st.]	Type verpakking	Aantal per omverpakking [st.]	
8,0	60	50	14,8	HD-40	●	61956	100	O-BOX	400
	80	70	14,8	HD-40	●	61957	100	O-BOX	400
	100	90	14,8	HD-40	●	61958	100	O-BOX	400
	120	110	14,8	HD-40	●	61266	100	O-BOX	400
	160	150	14,8	HD-40	●	61289	100	O-BOX	400
	180	170	14,8	HD-40	●	61301	100	O-BOX	400
10,0	120	110	18,5	HD-40	●	61488	50	O-BOX	200
	160	150	18,5	HD-40	●	61506	50	O-BOX	200

* Alle schroeven met HECO-Drive zijn 100% compatibel met conventionele TX-bits.
Het GripFit-effect is alleen gegarandeerd bij gebruik met passende HECO-Drive-bits.

HECO-TOPIX®-plus Vloerplaatschroef

Productinformatie

- Aantrekken en fixeren met slechts één schroef
- Gereduceerde splijtwerking bij het inschroeven door boorpunt
- Snel aanzetten en inschroeven, in het bijzonder op harde oppervlakten
- Geen knarsen van het hout dankzij fixatie met de voldraad
- Tijdsbesparing door de inzet van één schroefvariant
- Goedgekeurd en bewaakt product (CE-markering)



De unieke vloerplaatschroef met het samentrekeffect

Platverzonken kop met freesholtes

Uitstekende freeseigenschappen in hout. Geen beschadiging van het oppervlak bij metalen beslag.

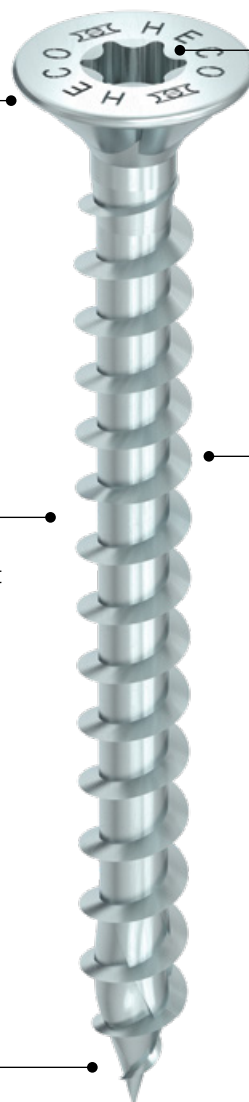

GripFit®

HECO-Drive maakt werken met één hand mogelijk



MagicClose®

Gepatenteerde voldraad trekt houten onderdelen spleetvrij samen zonder voorspannen



PerfectPitch®

Optimale schroefdraadspeed voor elke schroeflengte



HECO-TOPIX-plus-punt

Maakt voorboren overbodig en vermindert het risico van splijten van het hout



Uitvoering: Vloerplaatschroef, platverzonken kop met freesholtes

Aandrijving: HECO-Drive *

Draadtype: variabele voldraad

Materiaal: koolstofstaal

Oppervlakte: verzinkt blauw, A3K **CHROME (VI) FREE +**

Kleurcode op het HECO-etiket

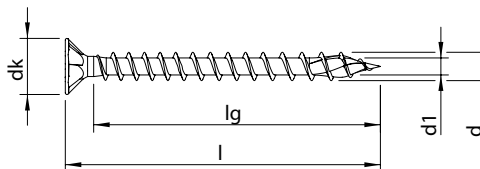
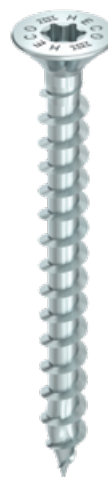

Afmeting d x l [mm]	Draadlengte lg [mm]	Kopdiameter dk [mm]	Aandrijving	ETA	Artikelnummer	Aantal per verpakking [st.]	Type verpakking	Aantal per omverpakking [st.]	
4,5	40	35	8,9	HD-20	•	62107	500	VARIANTA	5.000
	50	45	8,9	HD-20	•	60722	200	VARIANTA	2.000
	60	55	8,9	HD-20	•	60752	200	VARIANTA	2.000
	70	65	8,9	HD-20	•	60769	200	VARIANTA	2.000
	80	75	8,9	HD-20	•	60781	200	VARIANTA	2.000

* Alle schroeven met HECO-Drive zijn 100% compatibel met conventionele TX-bits.
Het GripFit-effect is alleen gegarandeerd bij gebruik met bijpassende HECO-Drive-bits.

HECO-TOPIX®-plus Vloerschroef

Productinformatie

- Aantrekken en fixeren met slechts één schroef
- Gereduceerde splijtwerking bij het inschroeven door boorpunt
- Geen knarsen van de vloerplanken door vaste fixering met de voldraad
- Makkelijk verzinken van de kop in de veer en verminderde spreidwerking
- Tijdsbesparing door de inzet van één schroefvariant
- Goedgekeurd en bewaakt product (CE-markering)



De unieke vloerschroef met het samentrekeffect

Kleine lenskop met freesribben

Voor gemakkelijk verzinken in de veer

MagicClose®

Gepatenteerde voldraad trekt houten onderdelen spleetvrij samen zonder voorspannen

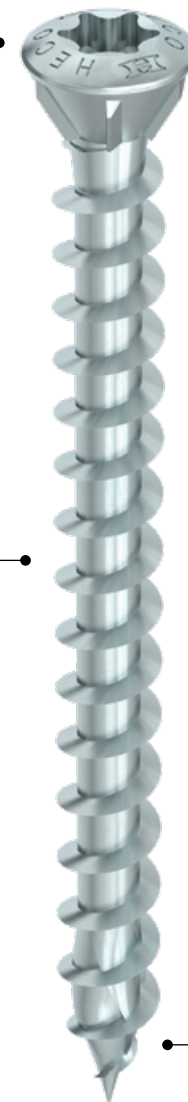

PerfectPitch®

Optimale schroefdraadspoed voor elke schroeflengte



HECO-TOPIX-plus-punt

Maakt voorboren overbodig en vermindert het risico van splijten van het hout

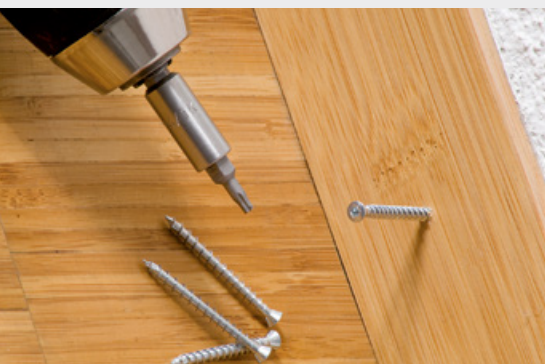

Uitvoering: Vloerschroef, verzonken lenskop met freesribben

Aandrijving: T-Drive



Draadtype: variabele voldraad

Materiaal: koolstofstaal

Oppervlakte: verzinkt blauw, A3K **CHROME (VI) FREE +**

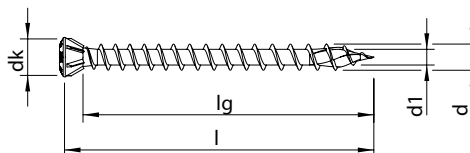
Kleurcode op het HECO-etiket



Afmeting d x l [mm]	Draadlengte lg [mm]	Kopdiameter dk [mm]	Aandrijving	ETA	Artikelnummer	Aantal per verpakking [st.]	Type verpakking	Aantal per omverpakking [st.]	
3,5 	40	37	5,3	T-10	•	60293	200	SKV	4.000
	40	37	5,3	T-10	•	60294	500	VARIANTA	5.000
	50	47	5,3	T-10	•	60328	200	SKV	4.000
	50	47	5,3	T-10	•	60329	500	VARIANTA	5.000
	60	57	5,3	T-10	•	60346	200	VARIANTA	2.000
	60	57	5,3	T-10	•	60348	500	VARIANTA	5.000
4,0 	40	36	6,1	T-15	•	64596 NIEUW	500	VARIANTA	5.000
	50	46	6,1	T-15	•	64597 NIEUW	500	VARIANTA	5.000
	60	56	6,1	T-15	•	64598 NIEUW	500	VARIANTA	5.000
	70	66	6,1	T-15	•	60564	200	VARIANTA	2.000
	70	66	6,1	T-15	•	60565	500	O-BOX	2.000
4,5 	50	46	6,8	T-20	•	60719	200	VARIANTA	2.000
	50	46	6,8	T-20	•	60721	500	VARIANTA	5.000
	60	56	6,8	T-20	•	60750	200	VARIANTA	2.000
	60	56	6,8	T-20	•	60751	500	O-BOX	2.000
	70	66	6,8	T-20	•	60766	200	VARIANTA	2.000
	70	66	6,8	T-20	•	60768	500	O-BOX	2.000
	80	76	6,8	T-20	•	60779	200	VARIANTA	2.000
	80	76	6,8	T-20	•	60780	500	O-BOX	2.000



Uitvoering: Vloerschroef, verzonken lenskop met freesribben

Aandrijving: T-Drive



Draadtype: variabele voldraad

Materiaal: roestvaststaal A2 1.4567

Oppervlakte: blank, glijcoating

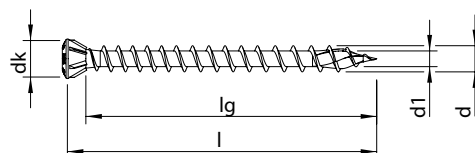
Kleurcode op het HECO-etiket



Afmeting d x l [mm]	Draadlengte lg [mm]	Kopdiameter dk [mm]	Aandrijving	ETA	Artikelnummer	Aantal per verpakking [st.]	Type verpakking	Aantal per omverpakking [st.]	
3,5	40	37	5,3	T-10	•	61644	200	SKV	4.000
	 50	47	5,3	T-10	•	61651	200	SKV	4.000
	60	57	5,3	T-10	•	61654	200	SKV	4.000
4,0	40	36	6,1	T-15	•	64599 NIEUW	200	SKV	4.000
	 50	46	6,1	T-15	•	64600 NIEUW	200	SKV	4.000
	60	56	6,1	T-15	•	64601 NIEUW	200	SKV	4.000



Uitvoering: Vloerschroef, verzonken cilinderkop

Aandrijving: T-Drive

Draadtype: variabele voldraad

Materiaal: roestvaststaal A2 1.4567

Oppervlakte: blank, glijcoating

Kleurcode op het HECO-etiket

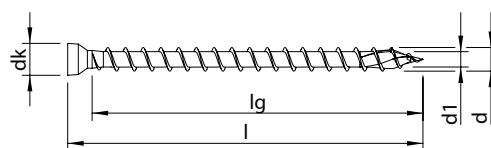

Afmeting d x l [mm]	Draadlengte lg [mm]	Kopdiameter dk [mm]	Aandrijving	ETA	Artikelnummer	Aantal per verpakking [st.]	Type verpakking	Aantal per omverpakking [st.]	
3,5*	40	36	4,3	T-10	•	64655 NIEUW	200	SKV	4.000

Beschikbaarheid en data op aanvraag.

** Kleurcode HD bit = 

HECO-TOPIX®-plus Gevelschroef

Productinformatie

- Aantrekken en fixeren van de gevelplank met één schroef
- Duurzame fixering en hogere aantreklasten dankzij HECO-TOPIX-plus voldraad
- Splijtvrij aantrekken van de gevelplank
- Uitvoering in roestvaststaal A2 voor duurzame en gestandaardiseerde montage voor gebruiksklasse 3
- Goedgekeurd en bewaakt product (CE-markering)



De unieke gevelschroef met het samentrekeffect

Kleine lenskop

Voor optische mooie montage en minder vochtophoping

GripFit®

HECO-Drive maakt werken met één hand mogelijk



MagicClose®

Gepatenteerde voldraad trekt houten onderdelen spleetvrij samen zonder voorspannen

PerfectPitch®

Optimale schroefdraadspeed voor elke schroeflengte



HECO-TOPIX-plus-punt

Maakt voorboren overbodig en vermindert het risico van splijten van het hout



Uitvoering: Gevelschroef, verzonken lenskop met freesribben

Aandrijving: HECO-Drive*



Draadtype: variabele voldraad

Materiaal: roestvaststaal A2 1.4567

Oppervlakte: blank, glijcoating

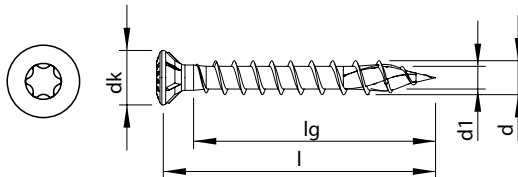
Kleurcode op het HECO-etiket



Afmeting d x l [mm]	Draadlengte lg [mm]	Kopdiameter dk [mm]	Aandrijving	ETA	Artikelnummer	Aantal per verpakking [st.]	Type verpakking	Aantal per omverpakking [st.]	
4,5 	50	45	7,2	HD-20	•	61706	200	VARIANTA	2.000
	60	55	7,2	HD-20	•	61711	200	VARIANTA	2.000
	70	65	7,2	HD-20	•	61715	200	VARIANTA	2.000
	80	75	7,2	HD-20	•	61720	200	VARIANTA	2.000
5,0 	40	34	7,2	HD-20	•	61743	200	VARIANTA	2.000
	50	44	7,2	HD-20	•	61759	200	VARIANTA	2.000
	60	54	7,2	HD-20	•	61772	200	VARIANTA	2.000
	70	64	7,2	HD-20	•	61783	200	VARIANTA	2.000
	80	74	7,2	HD-20	•	61793	200	VARIANTA	2.000

* Alle schroeven met HECO-Drive zijn 100% compatibel met conventionele TX-bits.
Het GripFit-effect is alleen gegarandeerd bij gebruik met bijpassende HECO-Drive-bits.

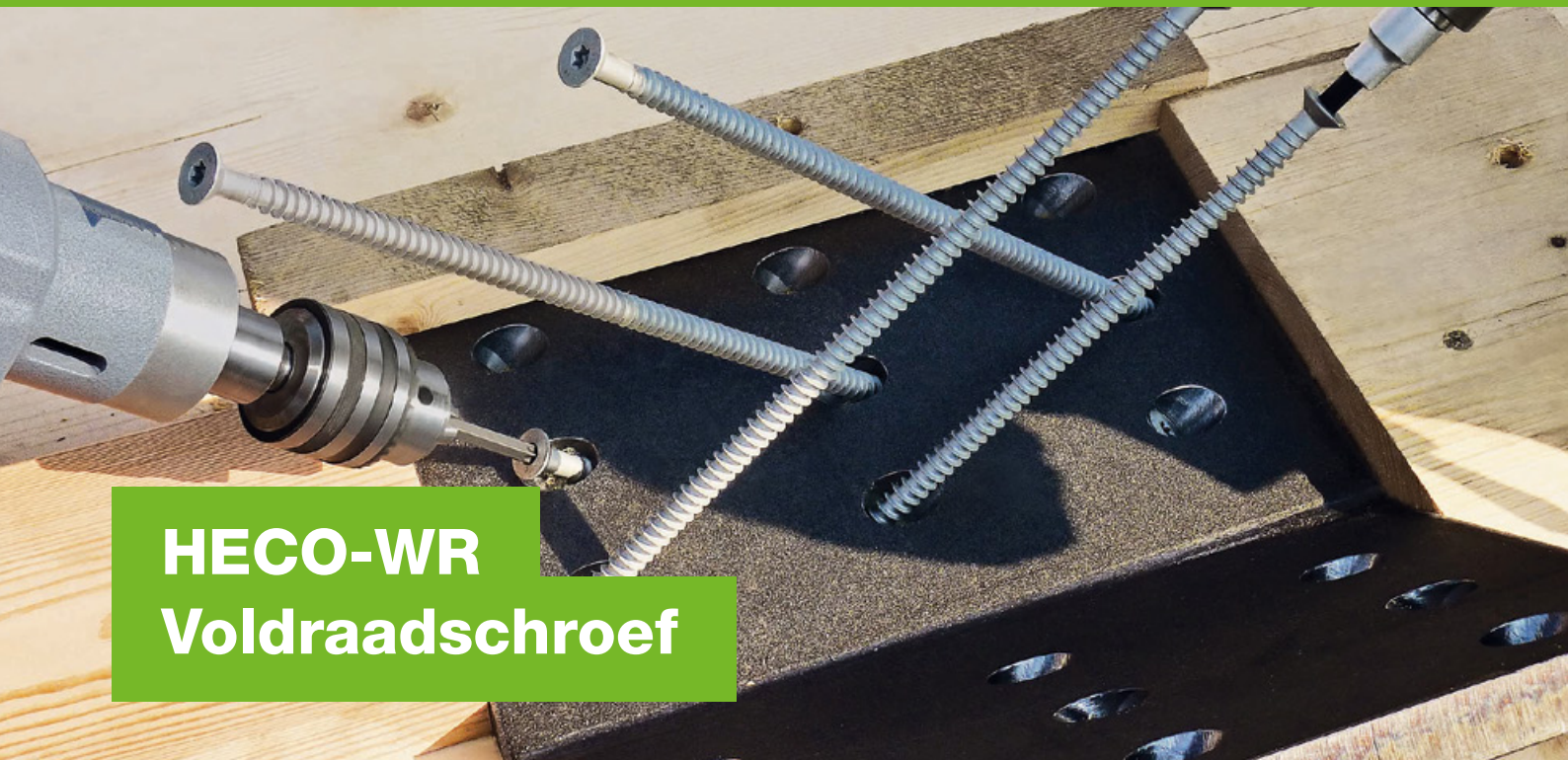

HECO-WR Voldraadschroef

Productinformatie

- Zeer hoog prestatievermogen
- Schroefverbindingen ook parallel tot de vezels mogelijk
- Geen vermindering van het draagvermogen van 90° tot 45° ten opzichte van de vezel
- Verwerking zonder voorboren
- Weinig neiging tot splijten, dus kleine rand- en tussenafstanden
- Tijd- en kostenverlaging
- Breed toepassingspectrum
- Hoge corrosiebescherming (Durocoat)
- Goedgekeurd en bewaakt product (CE-markering)



Meer power in de constructieve houtbouw

Platverzonken kop

Voldraad

Oppervlakte Durocoat

Ø9 met boorpunt

Ø13 met halve punt

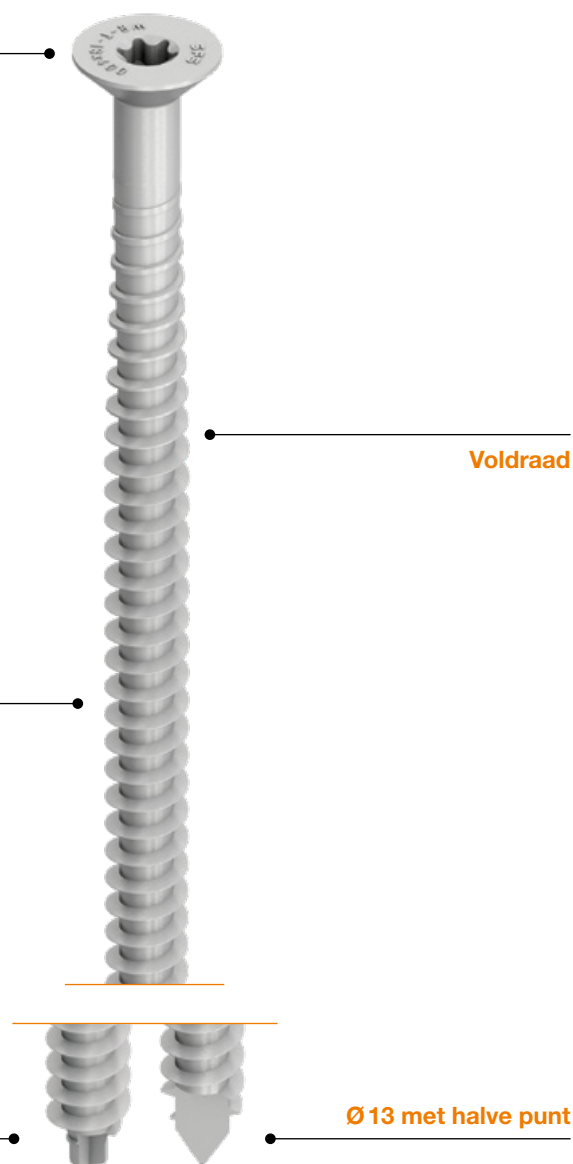

Uitvoering: HECO-WR Voldraadschroef, platverzonken kop

Aandrijving: T-Drive



Draadtype: voldraad

Materiaal: koolstofstaal

Oppervlakte: Durocoat **CHROME (VI) FREE +**

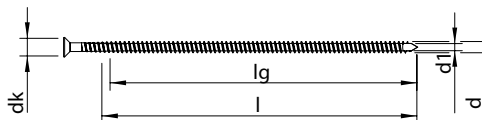
Kleurcode op het HECO-etiket



Afmeting d x l [mm]	Draadlengte lg [mm]	Kopdiameter dk [mm]	Aandrijving	ETA	Artikelnummer	Aantal per verpakking [st.]	Type verpakking	Aantal per omverpakking [st.]
9,0 	250	230	14,0	T-40	• 58835	50	O-BOX	200
	300	280	14,0	T-40	• 58836	50	O-BOX	100
	350	330	14,0	T-40	• 58837	50	O-BOX	100
	400	380	14,0	T-40	• 58838	50	O-BOX	100
	450	430	14,0	T-40	• 58839	50	O-BOX	100
	500	480	14,0	T-40	• 58840	50	O-BOX	100
13,0 	400	380	22,0	T-50	• 53334	25	O-BOX	50
	500	480	22,0	T-50	• 53336	25	O-BOX	50
	600	580	22,0	T-50	• 53337	25	O-BOX	-
	700	680	22,0	T-50	• 53338	25	O-BOX	-
	800	780	22,0	T-50	• 53339	25	O-BOX	-
	900	880	22,0	T-50	• 53340	25	O-BOX	-
1000	980	22,0	T-50	• 53341	25	O-BOX	-	

145

De passende houtbouwschroefhouder HECO-PowerLock vindt u op pagina 160, een inschroefhulp voor hoeken van 45° en 60° op pagina 167.

Toepassingsvoorbeelden

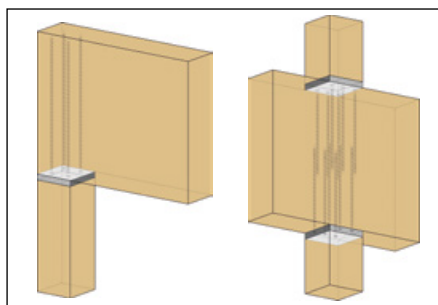

Draagvlakversterking

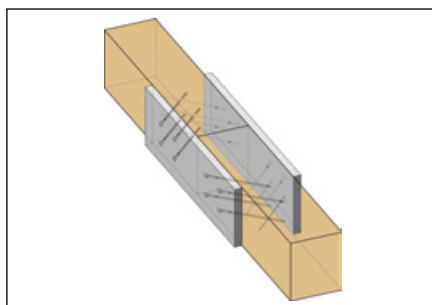

Staalplaten algemeen

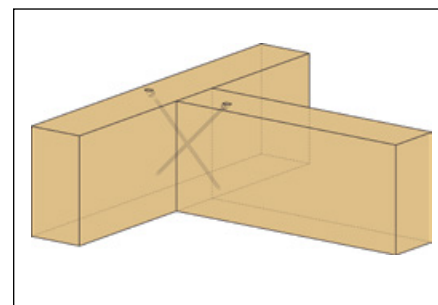

Hoofd-/hulppliggers

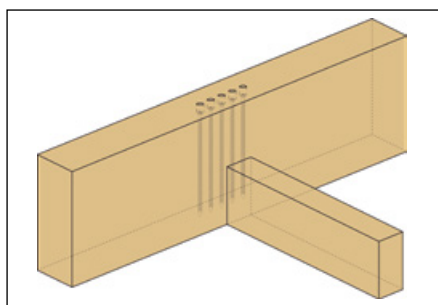

Dwarsversterking

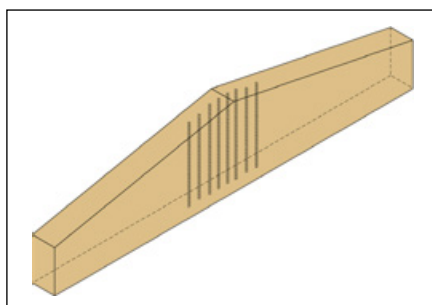

Zadeldaken

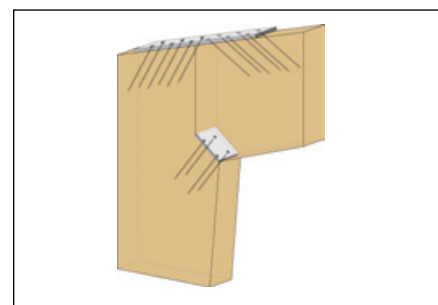

Raamhoeken

HECO-WS Zelfborende stalen deugel

Productinformatie

- Eenvoudig in gebruik zonder voorbereiden van hout en staal
- Zelfborend door de speciale boorpunt
- Geschikt voor talloze toepassingen
- Eenvoudige, betrouwbare berekening volgens EN 1995-1-1
- Hoog vloei-moment $M_{y,k}$
- Demonteerbaar
- Fixatie door middel van onderkopdraad
- Hoog brandweerstandsvormogen
- De vormvaste directe schroefverbinding
- Zorgt voor een maximale pasnauwkeurigheid
- Optisch aantrekkelijke verbinding zonder doorbreken van houten oppervlak aan achterkant

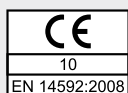

Meer efficiëntie in de houtbouw

Verzonken cilinderkop

Oppervlakte blauw verzinkt

Onderkopdraad

Zelfborend door de speciale boorpunt



Uitvoering: HECO-WS Zelfborende stalen deuvcl, verzonken cilinderkop

Aandrijving: T-Drive

Draadtype: onderkopdraad

Materiaal: koolstofstaal

Oppervlakte: verzinkt blauw, A2K **CHROME (VI) FREE +**

Kleurcode op het HECO-etiket

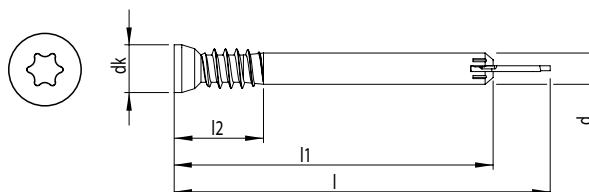
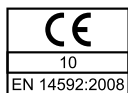

Afmeting d x l [mm]	Draadlengte lg [mm]	Nuttige lengte l1 [mm]	Lengte l2 [mm]	Kop-Ø dk [mm]	Aandrijving	CE	Artikelnummer	Aantal per verpakking [st.]	Type verpakking	Aantal per omverpakking [st.]
7,0	73	14	60	20	10,7	T-40	● 53342	100	O-BOX	400
●	93	14	80	20	10,7	T-40	● 53344	100	O-BOX	400
	113	14	100	20	10,7	T-40	● 53346	100	O-BOX	400
	133	14	120	20	10,7	T-40	● 53347	100	O-BOX	400
	153	14	140	20	10,7	T-40	● 53348	50	O-BOX	200
	173	14	160	20	10,7	T-40	● 53349	50	O-BOX	200
	193	14	180	20	10,7	T-40	● 53350	50	O-BOX	200
	213	14	200	20	10,7	T-40	● 53351	50	O-BOX	200
	233	14	220	20	10,7	T-40	● 53352	50	O-BOX	100

● = CE volgens EN 14592:2008 Het bijbehorende montagegereedschap vindt u op pagina 161

Toepassingsvoorbeelden

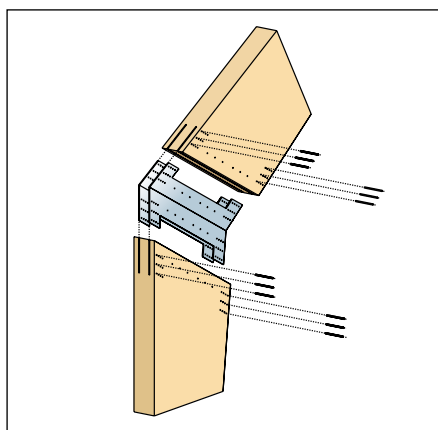

Raamhoek

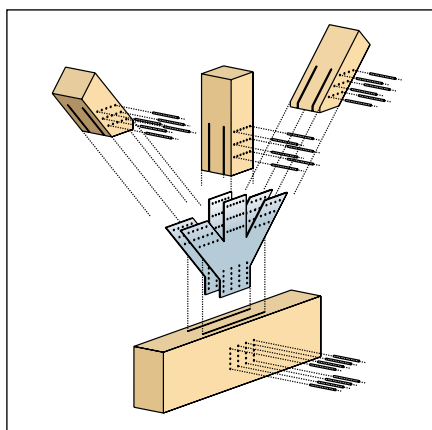

Vakwerk-Knooppunt

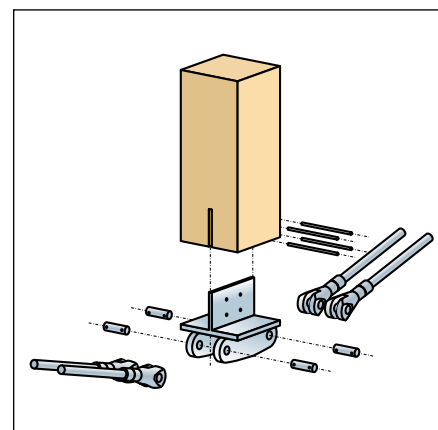

Onderspannen ligger

Andere toepassingen:

- Aansluiting stijl-regel
- Ingespannen paalvoet
- Verbindingen/saneringen
- Knooppunt van steunbalken
- e.a.

HECO-WB Houtbouwdraadstang

Productinformatie

- Dwarstrekkerversteviging zonder lijm
- Tot wel 50% tijdsbesparing
- Goedgekeurd zonder lijmgebruik
- Ongeacht de temperatuur
- Eenvoudige en veilige berekening
- Treksterkte tot 160 kN (karakteristiek)
- Individueel bijsnijden in de lengte mogelijk
- Eenvoudig voorraadbeheer
- Inschroefhuls voor verzinken
- Ook verkrijgbaar als variant met M12 of M16-aansluitschroefdraad
- Goedgekeurd en bewaakt product (CE-markering)



Dwarsverstevigingen eenvoudig opgelost

Houtbouwdraadstang
zonder kop

Variant met
M12-/M16-
aansluitschroefdraad

Oppervlakte blauw verzinkt

Schroefdraadgeometrie
DIN 7998



Uitvoering: **A** HECO-WB Houtbouwdraadstang **B** met aansluitschroefdraad

Aandrijving: zetgereedschap

Draadtype: voldraad

Materiaal: koolstofstaal

Oppervlakte: verzinkt blauw, A2K **CHROME (VI) FREE +**

Kleurcode op het HECO-etiket

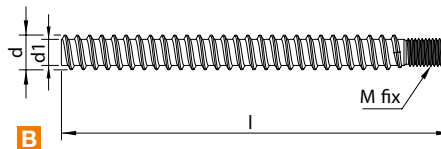
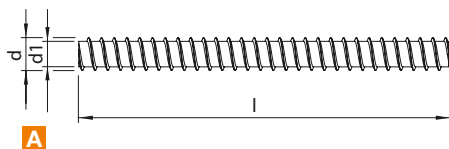

Afmeting d x l [mm]	Draadlengte lg [mm]	Kern-Ø d1 [mm]	Boor-Ø [mm]	Aansluitschroefdraad M _{fix} [mm]	ETA	Artikelnummer	Aantal per verpakking [st.]	Type verpakking	Aantal per omverpakking [st.]
16,0	2.200	2.200	12	12-13	-	A 59138	1*	Industrieel verp.	-
	**	**	12	12-13	-	A 59654	-*	Industrieel verp.	-
	1.000	920	12	12-13	M12 x 80	B 64302 NIEUW	1*	Industrieel verp.	-
20,0	2.200	2.200	15	15-16	-	A 59139	1*	Industrieel verp.	-
	**	**	15	15-16	-	A 59659	-*	Industrieel verp.	-
	1.000	900	15	15-16	M16 x 100	B 59140	1*	Industrieel verp.	-
	1.500	1.400	15	15-16	M16 x 100	B 59141	1*	Industrieel verp.	-

* Minimale bestelhoeveelheid 5 stuks/snitten ** Individuele lengtesnitten op aanvraag, max. 3.000 mm

Bijpassende accessoires en montagegereedschappen vindt u op pagina's 162 & 163

Toepassingsvoorbeelden

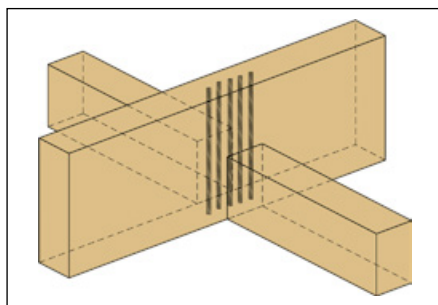

Dwarsaansluitingen

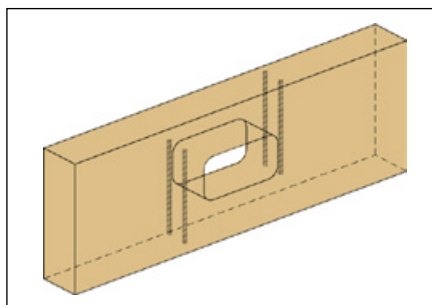

Gaten

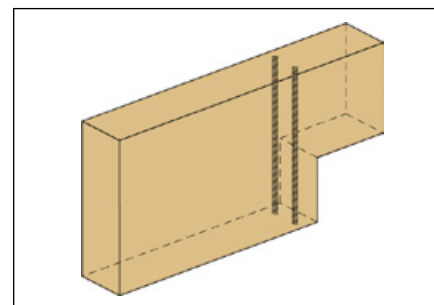

Ontkoppelingen

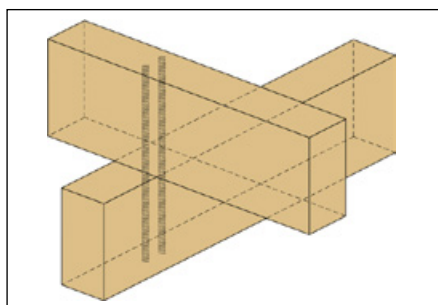

Verbindingen

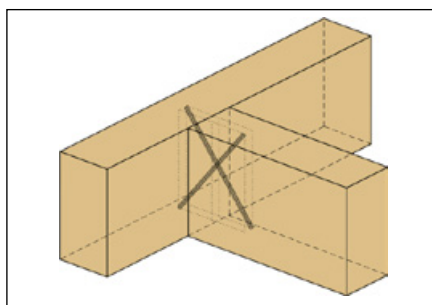

Aansluitingen voor hoofd- en hulpliggers

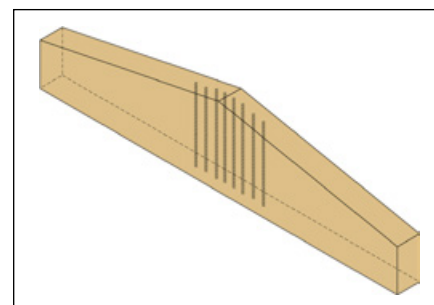

Zadeldakbalken



HECO-VB Hout-beton-verbindingschroef

Productinformatie

- Ideaal voor de renovatie van oude gebouwen en nieuwbouw
- Gebruik van bestaande bouwsubstantie
- Minimale ingreep en korte bouwperiode
- Aanzienlijke kostenbesparing vergeleken met conventionele oplossingen
- Groot draagvermogen bij een geringe opbouwhoogte
- Verbetering van de geluidsisolatie
- Verbetering van de brandbeveiliging
- Dimensioneringsbewijzen via HBV-software of dimensionerings-service
- Goedgekeurd en bewaakt product (CE-markering)



De toonaangevende methode bij hout-beton-composietplafonds

Speciale kop

Met TORX-aangrijping E8 voor goede geleiding tijdens de installatie



Kraag

Voor constante en betrouwbare zetdiepte

Schroefdraad

Gering indraaimoment zonder voorboren

De HBV-software maakt een efficiënte dimensionering mogelijk



Uitvoering: HECO-VB Hout-beton-verbindingsschroef, speciale kop

Aandrijving: TX-aandrijving E8

Draadtype: deeldraad

Materiaal: koolstofstaal

Oppervlakte: verzinkt blauw, A2K **CHROME (VI) FREE +**

Kleurcode op het HECO-etiket

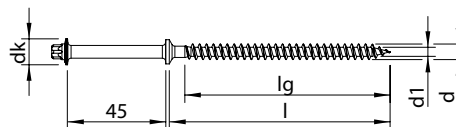

Afmeting d x l [mm]	Draadlengte lg [mm]	Kopdiameter dk [mm]	Aandrijving	ETA	Artikelnummer	Aantal per verpakking [st.]	Type verpakking	Aantal per omverpakking [st.]
7,5	100	95	12,0	TX-E8	• 58841	100	O-BOX	400
	165	135	12,0	TX-E8	• 58842	100	O-BOX	200

Het bijbehorende montagegereedschap vindt u op pagina 164

Wij adviseren u graag!
Bel ons gerust:
07422 / 989 – 300

Toepassingsvoorbeelden

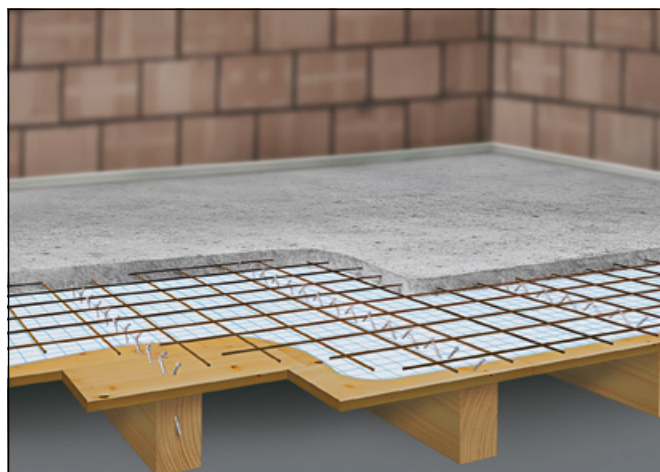

MULTI-MONTI®-plus Schroefankers voor houtbouw

De voordelen in beton

- Groter goedgekeurd assortiment voor ETA optie 1 vanaf MMS-plus 6, inclusief seismische lasten vanaf 10 mm
- Geoptimaliseerde betondraad met voldraad varianten voor de hoogste eisen
- Tot aan drie montagediepten voor meer flexibiliteit
- Machinaal te monteren en direct belastbaar
- Montagevriendelijk schroefanker ook bij zwaar versleten boren

De voordelen in metselwerk

- Mit ETA-Zulassung (ETA-20/0132)
- Goedgekeurd voor baksteen, massieve kalkzandsteen, holle kalkzandsteen en licht beton
- Toegestaan voor brandbelasting in metselwerk
- Optimale schroefdraad voor veilig en snel bevestigen in metselwerk
- Montage zonder reiniging van het boorgat toegestaan
- Twee zetdieptes voor meer flexibiliteit
- Eenvoudig te monteren en direct belastbaar

Hoogwaardige schroefankers voor het bevestigen van houten onderdelen aan beton en metselwerk

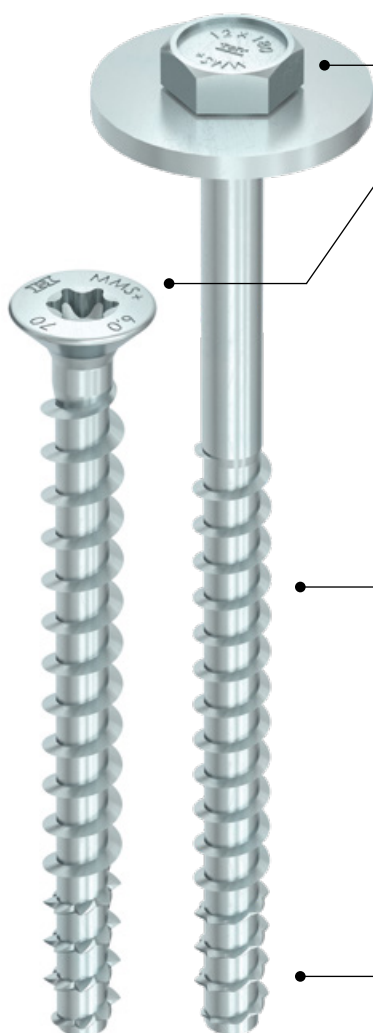

Kopstempel MMS+

Voor een eenvoudige indentificatie van het anker, ook na montage



Ideale kern/draad geometrie

Maakt eenvoudig inschroeven en hoge draagkrachten mogelijk

Functionele punt met vertanding

Reduceert slijtage en maakt zo meervoudig gebruik bij tijdelijke bevestigingen mogelijk



Voor bevestigingen in beton

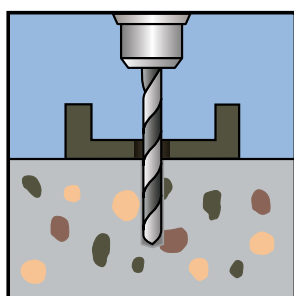

1. Boren

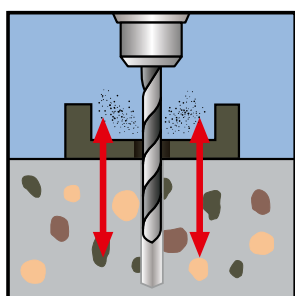

2. Boorgat schoonmaken

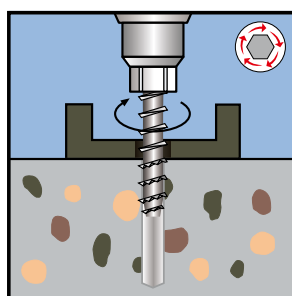

3. Inschroeven

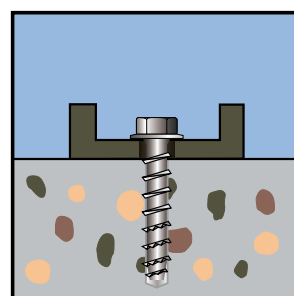

4. Klaar

153

Voor bevestigingen in metselwerk

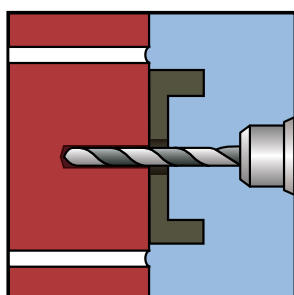

1. Boorgat maken (klopboor)

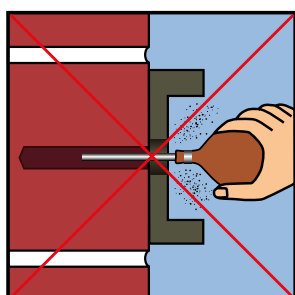

2. Boormeel hoeft niet te worden verwijderd!

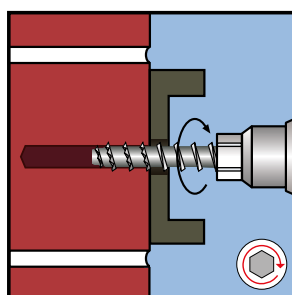

3. Inschroeven (schroefboormachine)

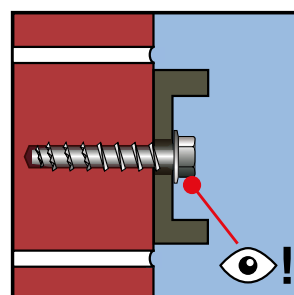

4. Erop letten dat kop goed aansluit → Klaar.



Uitvoering: MMS-plus S, zeskantkop, met sluitring DIN 440

Aandrijving: zeskantkop

Materiaal: koolstofstaal

Oppervlakte: verzinkt blauw, A2K **CHROME (VI) FREE** +

Kleurcode op het HECO-etiket

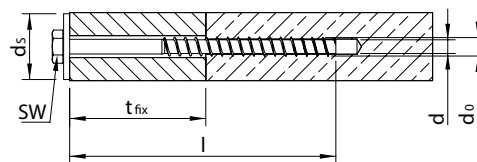

Afmeting d x l [mm]	Boor-Ø d ₀ [mm]	Klemdikte t _{fix} [mm]	Ringdiameter d _s [mm]	Aandrijving	ETA	Artikelnummer	Aantal per verpakking [st.]	Type verpakking	Aantal per omverpakking [st.]
12,0	180	10,0	90/105	44,0	SW-19	● 48463	25	O-BOX	50
	200	10,0	110/125	44,0	SW-19	● 48465	25	O-BOX	50
	240	10,0	150/165	44,0	SW-19	● 48467	25	O-BOX	50
	280	10,0	190/205	44,0	SW-19	● 48469	25	O-BOX	50
	320	10,0	230/245	44,0	SW-19	● 48471	25	O-BOX	50

Uitvoering: MMS-plus F, platverzonken kop

Aandrijving: T-Drive

Materiaal: koolstofstaal

Oppervlakte: verzinkt blauw, A2K **CHROME (VI) FREE +**

Kleurcode op het HECO-etiket

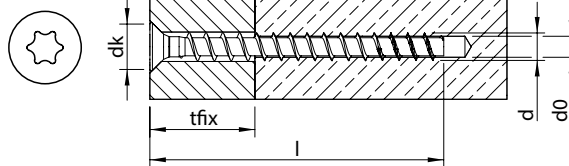

Afmeting d x l [mm]	Boor-Ø d ₀ [mm]	Klemdikte t _{fix} [mm]	Kopdiameter d _k [mm]	Aandrijving	ETA	Artikelnummer	Aantal per verpakking [st.]	Type verpakking	Aantal per omverpakking [st.]	
6,0 ★	80	5,0	35/45/(55)	11,5	T-30	●	48501	50	O-BOX	500
	100	5,0	55/65/(75)	11,5	T-30	●	48503	50	O-BOX	500
	120	5,0	75/85/(95)	11,5	T-30	●	48505	50	O-BOX	500
	140	5,0	95/105/(115)	11,5	T-30	●	48507	50	O-BOX	500
7,5 ★	100	6,0	45/65/(75)	15,5	T-40	●	48517	50	O-BOX	500
	120	6,0	65/85/(95)	15,5	T-40	●	48519	50	O-BOX	400
	140	6,0	85/105/(115)	15,5	T-40	●	48521	50	O-BOX	400
	160	6,0	105/125/(135)	15,5	T-40	●	48523	50	O-BOX	400

* (...) = t_{fix}-waarden tussen haakjes gelden alleen bij het gebruik van de schroeven in redundante, niet-dragende systemen (zie ETA-15/0785)

MULTI-MONTI® TimberConnect

Productinformatie

- Voor het veilig bevestigen van houten onderdelen aan beton
- Snel en eenvoudig machinaal zetbaar, geen specifiek aandraaimoment nodig
- Geen uithardingstijden: de verbinding is onmiddellijk belastbaar
- Drie afmetingen voor houten aanbouwdelen van 40 mm tot 300 mm
- Transmissie van hoge trek- en schuifkrachten zonder extra ontwerpinspanning
- Maakt montagepunten vlak met het oppervlak mogelijk
- Veilig in gebruik, geen verborgen installatiefouten mogelijk
- Goedgekeurd en gecontroleerd product



Het unieke anker met dubbele schroefdraad voor bevestiging van houten onderdelen aan beton

Kleine verzonken cilinderkop

Kan moeiteloos in het hout worden verzonken en kan dus flexibel worden gebruikt in verschillende houtdiktes

Betondraad

Zorgt voor krachtige verankering verankering in beton

Houtdraad

Zorgt voor een stevige bevestiging van het houten aanbouwdeel

Vertande functionele punt

Maakt snelle en eenvoudige montage mogelijk



Uitvoering: MMS-TC TimberConnect

Aandrijving: T-Drive

Materiaal: koolstofstaal

Oppervlakte: verzinkt blauw, A2K **CHROME (VI) FREE** +

Kleurcode op het HECO-etiket

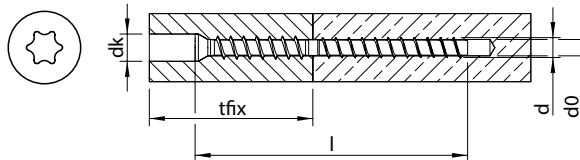

Afmeting d x l [mm]	Boor-Ø d _b [mm]	Klemdikte t _{kl} [mm]	Kopdiameter d _k [mm]	Aandrijving	ETA	Artikel-nummer	Aantal per verpakking [st.]	Type verpakking	Aantal per omverpakking [st.]	
7,5¹	100	6,0	40–140	10,0	T-30	●	48308	50	O-BOX	500
10,0²	130	8,0	60–200	16,0	T-45	●	48310	25	O-BOX	250
12,0³	160	10,0	80–300	17,5	T-50	●	48312	25	O-BOX	100

Het bijbehorende zetgereedschap vindt u op pagina 165

¹ Kleurcodering T-30-Bit = ● ² Kleurcodering T-45-Bit = ● ³ Kleurcodering T-50-Bit = ●

De juiste montage

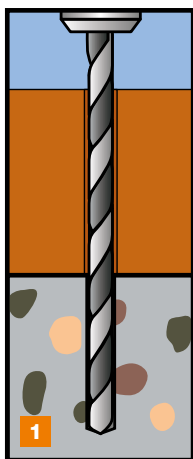

1. Boren

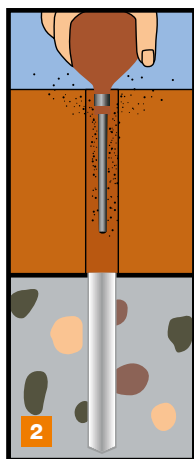

2. Boorgat schoonmaken

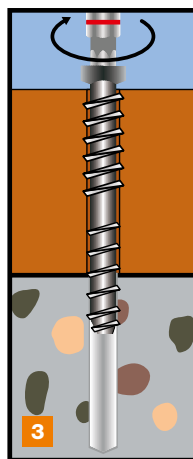

3. Inschroeven

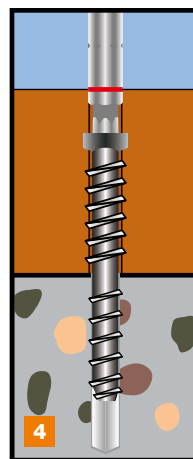

4. Klaar



Video

MULTI-MONTI®-plus Therm

Productinformatie

- Voor het bevestigen van tengels op beton op geïsoleerde daken en gevels
- Kan worden gebruikt voor alle gebruikelijke isolatiematerialen zonder eisen aan de druksterkte
- Tot drie montage diepten voor meer flexibiliteit
- Kan snel en eenvoudig machinaal worden gemonteerd, geen gedefinieerd aandraaimoment vereist
- Veilig in gebruik, geen verborgen installatiefouten mogelijk



Het ideale schroefanker voor het bevestigen van tengels op beton op geïsoleerde daken en gevels

Gilinderkop

Voor spleetvrije installatie in het houten aanbouwdeel

Onderkopdraad

Voor een veilige bevestiging van de tengel

Betondraad

Zorgt voor een krachtige verankering in beton

Vertande functionele punt

Maakt snelle en eenvoudige installatie mogelijk



Uitvoering: MMS-plus Therm, cilinderkop

Aandrijving: T-Drive

Materiaal: koolstofstaal

Oppervlakte: verzinkt blauw, A2K **CHROME (VI) FREE +**

Kleurcode op het HECO-etiket

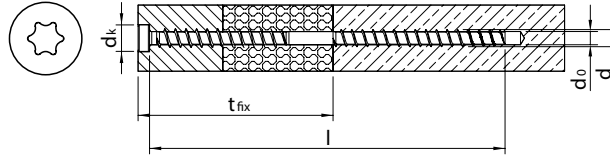

Afmeting d x l [mm]	Boor-Ø d ₀ [mm]	Klemdikte t _{fix} [mm]	Kopdiameter d _k [mm]	Aandrijving	ETA	Artikelnummer	Aantal per verpakking [st.]	Type verpakking	Aantal per omverpakking [st.]	
7,5 	180	6,0	125/145/(155)	12,0	T-40	●	64059	50	O-BOX	200
	200	6,0	145/165/(175)	12,0	T-40	●	64060	50	O-BOX	200
	220	6,0	165/185/(195)	12,0	T-40	●	64061	50	O-BOX	200
	240	6,0	185/205/(215)	12,0	T-40	●	64062	50	O-BOX	200
	260	6,0	205/225/(235)	12,0	T-40	●	64063	50	O-BOX	200
	280	6,0	225/245/(255)	12,0	T-40	●	64064	50	O-BOX	200
	300	6,0	245/265/(275)	12,0	T-40	●	64065	50	O-BOX	200
	320	6,0	265/285/(295)	12,0	T-40	●	64066	50	O-BOX	200
	340	6,0	285/305/(315)	12,0	T-40	●	64067	50	O-BOX	200

* (...) = t_{fix}-waarden tussen haakjes gelden alleen bij het gebruik van de schroeven in redundante, niet-dragende systemen (zie ETA-15/0785)



HECO-PowerLock Houtbouwschroevenhouder

Productinformatie

- Voorkomt dat het bit wegglijdt van de schroefkop
- Maakt krachtbesparend indraaien mogelijk
- Maakt een snelle en betrouwbare montage mogelijk
- Max. draaimoment 130Nm
- Inclusief T-40 en T-50 bits



▶ Video



Vervangende bits:

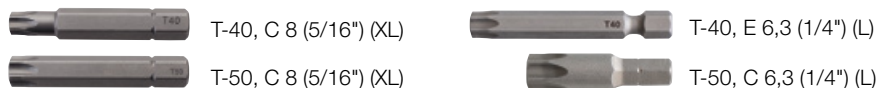

Beschrijving: HECO-PowerLock Houtbouwschroevenhouder incl. bits

Uitvoering	Artikelnummer	Aantal [st.]	Type verpakking
HECO-PowerLock XL, incl. T-40 en T-50 bit	57263	1	Bliester
Vervangend bit voor HECO-PowerLock XL, T-40	57762	1	Bliester
Vervangend bit voor HECO-PowerLock XL, T-50	57763	1	Bliester
HECO-PowerLock L, incl. T-40 en T-50 bit	63959	1	Bliester
Vervangend bit voor HECO-PowerLock L, T-40	63960	1	Bliester
Vervangend bit voor HECO-PowerLock L, T-50	63961	1	Bliester
Adapter MK 3 – Binnenzeskant 11,5 mm	58662	1	Bliester

Compatibiliteitsoverzicht

Uitvoering	Artikelnummer	Geslacht voor schroeven met kopdiameter, d.
HECO-PowerLock XL	57263	16,5–22,5mm
HECO-PowerLock L	63959	10–16,5mm

Accessoires voor HECO-WS

Productinformatie

- Afgestemd systeem
- Betrouwbaar en robuust voor gebruik bij veeleisende projecten
- Voor comfortabele en efficiënte montage
- Eenvoudig en ongecompliceerd gebruik
- Advies en instructies middels toepassingstechniek
- Ook als voordelig huurapparaat voor de duur van het project
- Vervangende bits ook apart verkrijgbaar

Voor een efficiënte montage van de HECO-WS staalen deuvels



Magnetische bithouder



Vervangend bit voor
CF-WS-M



Vervangend bit voor
CF-WS-P

Beschrijving: Onderdelen voor HECO-WS montagegereedschappen

Uitvoering	Artikelnummer	Aantal [st.]	Type verpakking
Magnetische bithouder voor CF-WS/M, E 6,3 (1/4") Bitopname: Universeel voor zeskant 6,3 (1/4")	59296	1	Plastic zak
Bit voor CF-WS-M, T-40, 70 mm, C 6,3 (1/4")	59297	1	Plastic zak
Bit voor CF-WS/P, T-40, 40 mm, M8	59298	1	Plastic zak



Montagegereedschap pneumatisch
CF WS/P
Art.-Nr. 59287



Montagegereedschap handmatig
CF WS/M
Art.-Nr. 59288

De bijbehorende HECO-WS staalen deuvels vindt u op pagina 147

Inschroefhulzen voor HECO-WB

Productinformatie

- Robuuste afwerking
- Verzinkbaar
- Met 1/2"-steeksleutelaandrijving
- Ook verkrijgbaar voor HECO-WB met aansluitschroefdraad M16

Het speciaal voor de HECO-WB houtbouwdraadstang ontwikkelde zetgereedschap



Voor HECO-WB Ø 16 mm resp. Ø 20 mm met aansluitschroefdraad M16



Voor HECO-WB Ø 20 mm (zonder aansluitschroefdraad)

Beschrijving: HECO-WB Inschroefhulzen

Uitvoering	Artikelnummer	Aantal [st.]	Type verpakking
HECO-WB Inschroefhuls Ø 16 mm	53355	1	Plastic zak
HECO-WB Inschroefhuls Ø 20 mm	53356	1	Plastic zak
HECO-WB Inschroefhuls Ø 20 mm met aansluitschroefdraad M16	64200 NIEUW	1	Plastic zak

De bijbehorende HECO-WB draadstangen vindt u op pagina 149

Boorsystemen voor HECO-WB

Productinformatie

- Hout-spiraalboor
- Geoptimaliseerd voor gebruik met HECO-WB draadstangen
- In een set met verlenging tot een totale lengte van max. 2,4 m
- Vervangende boor apart verkrijgbaar



Productaanbeveling voor optimale verwerking:

Schroefboormachine EHB 32/2.2 R R/L of een soortgelijk product

Aangegeven vermogen:

1800 W, 22-80 Nm, 60-470 omw./min



Boorsysteem met verlenging (in de set)



Vervangende boor (afzonderlijk)

163

Beschrijving: Boorsysteem voor HECO-WB

Uitvoering	Diameter	Artikelnummer	Aantal [st.]	Type verpakking
Boorsysteem voor HECO-WB-16	12	59283	1	SFS-Box
Vervangende boor voor HECO-WB-16	12	59285	1	SFS-Box
Boorsysteem voor HECO-WB-20	15	59284	1	SFS-Box

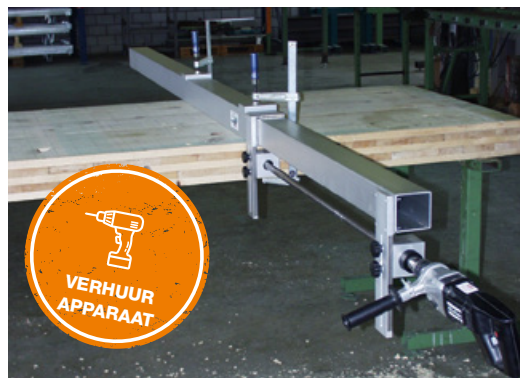

Diepgatboorsysteem DWA-systeem persluchtondersteund, complete set Art.-Nr. 59292

De bijbehorende HECO-WB draadstangen vindt u op pagina 149



Accessoires voor HECO-VB

Productinformatie

- Afgestemd systeem
- Betrouwbaar en robuust voor gebruik bij veeleisende projecten
- Voor comfortabele en efficiënte montage
- Eenvoudig en ongecompliceerd gebruik
- Advies en instructies middels toepassingstechniek
- Ook als voordelig huurapparaat voor de duur van het project
- Vervangende bits ook apart verkrijgbaar

Voor een efficiënte montage van de HECO-VB hout-beton-verbindingsschroeven



Vervangend bit



Verlenging

Beschrijving: Onderdelen voor HECO-VB montagegereedschappen

Uitvoering	Artikelnummer	Uitgang	Aandrijving	Aantal [st.]	Type verpakking
Vervangend bit voor CF-VB/L	59299	Buiten-TX E8	Vierkant 6,3 (1/4")	1	Plastic zak
Verlenging voor CF-VB/L	59300	Vierkant 6,3 (1/4")	E 6,3 (1/4")	1	Plastic zak



Montagegereedschap handmatig
CF VB/L
Art.-Nr. 59289

De bijbehorende HECO-VB hout-beton-verbindingsschroeven vindt u op pagina 151

Zetgereedschap voor MULTI-MONTI-TimberConnect

Productinformatie

- Het voor MMS-TC voorgeschreven zetgereedschap
- Speciaal voor HECO vervaardigde zetgereedschap
- Goedgekeurd Z-21.1-1879
- Inschroefdieptemarkering met schaalverdeling voor MMS-TC
- Afgestemd systeem van schroef en bit:
 - betere pasnauwkeurigheid
 - optimale krachtoverbrenging
 - minder doldraaien
- Lange levensduur



Voor de juiste montage van MULTI-MONTI-TimberConnect

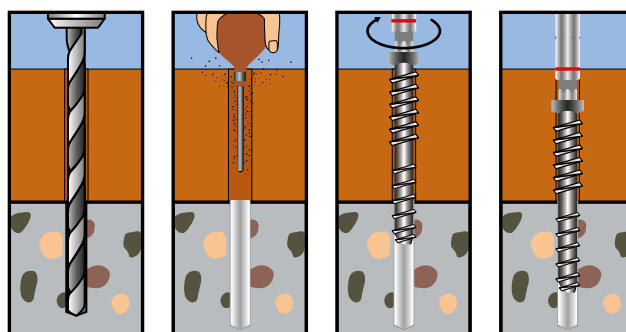

▶ Video

Beschrijving: Zetgereedschap voor MULTI-MONTI-TimberConnect

Uitvoering	Uitgang	Aandrijving	Art.Nr.	Aantal [st.]	Type verpakking
Voor MMS-TC Ø 7,5mm	T-30	9,5 mm (3/8")	43603	1	Bliester
Voor MMS-TC Ø 10mm	T-45	12,5 mm (1/2")*	47095	1	Bliester
Voor MMS-TC Ø 12mm	T-50	12,5 mm (1/2")*	43605	1	Bliester

Bijbehorend schroefanker MMS-TC vindt u op pagina 157

* Met 1/2"-steeksleutelaandrijving



HECO-Onderlegschijven

Productinformatie

- Onderlegschijven voor HECO-TOPIX-plus schroeven met platverzonken kop, diameter 8 en 10mm



Voor HECO-TOPIX-plus schroeven met platverzonken kop



Beschrijving: Onderlegschijven, verzinkt blauw, A2K

Uitvoering	Schroef-Ø [mm]	Artikelnummer	Aantal [st.]	Type verpakking
Onderlegschijven, Ø 25 mm	8	42260	50	SKV
Onderlegschijven, Ø 30 mm	10	42281	50	SKV



HECO-Inschroefhulp

Productinformatie

- 60° en 45° tov oppervlakte
- 45°-inschroeven ook dicht aan de rand mogelijk
- Met schaalverdeling
- Gereedschap glijdt niet weg door speciale vorm

Inschroefhulp voor HECO-TOPIX-plus houtbouschroeven



167

Beschrijving: HECO-inschroefhulp, kunststof, oranje

Uitvoering	Artikelnummer	Aantal [st.]	Type verpakking
HECO-Inschroefhulp	45734	1	Karton

De bijpassende HECO-TOPIX-plus houtbouschroeven, HECO-TOPIX-plus Therm en HECO-TOPIX-plus CombiConnect vindt u op pagina's 127 en 124



Schroeven voor beton en metselwerk

STALEN SCHROEVEN

MULTI-MONTI-plus SS/S, zeskantkop	174-176
MULTI-MONTI-plus S, zeskantkop, met sluitring DIN 440	177
MULTI-MONTI-plus V, Voorsteekanker	178
MULTI-MONTI-plus F, platverzonken kop	179
MULTI-MONTI-plus MS, Montagerailschroef	180
MULTI-MONTI-plus ST, Stokanker	181
MULTI-MONTI-plus I, Binnendraadanker	182
MULTI-MONTI-plus P, rondkop (PanHead)	183
MULTI-MONTI-plus KS, Kabelklemschroef	184
MULTI-MONTI-plus R, Ooganker	188
MULTI-MONTI-TimberConnect	186
MULTI-MONTI-plus SSK, Schorenanker	188
MULTI-MONTI-plus Therm	190

ROESTVASTSTALEN SCHROEVEN

MULTI-MONTI-plus SS, zeskantkop, roestvaststaal A4	193
MULTI-MONTI-plus F, platverzonken kop, roestvaststaal A4	194
MULTI-MONTI-plus P, rondkop (PanHead), roestvaststaal A4	195
MULTI-MONTI-plus MS, Montagerailschroef, roestvaststaal A4	195

ACCESSOIRES

MULTI-MONTI-plus Seismische kits	196
Zetgereedschappen voor MULTI-MONTI-TimberConnect	198
Meethulzen voor MULTI-MONTI-plus	199

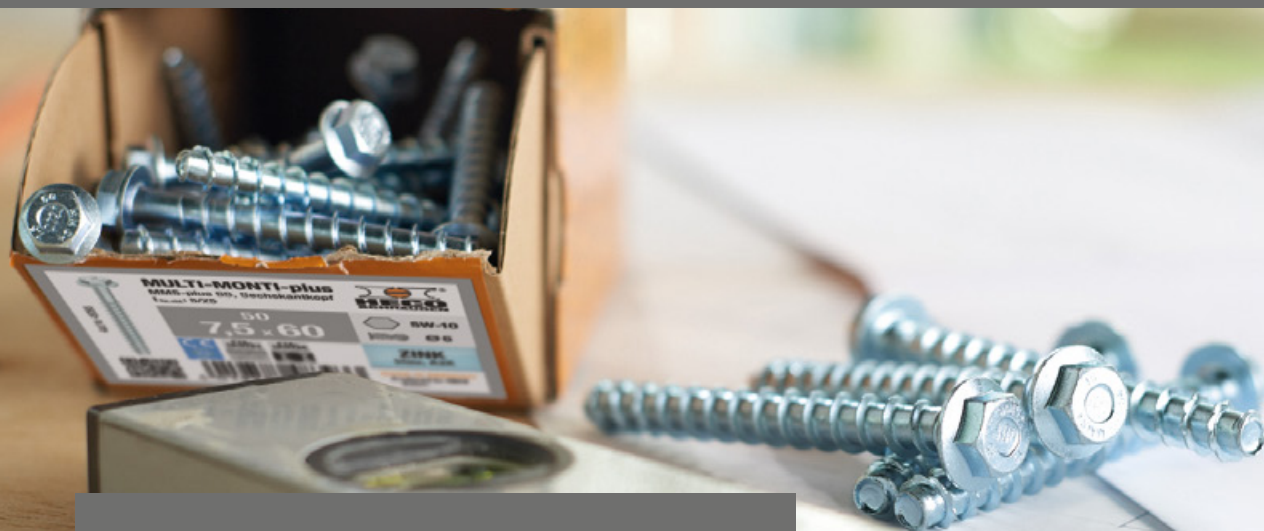

MULTI-MONTI®-plus Schroefankers

De voordelen in beton

- Groter goedgekeurd assortiment voor ETA optie 1 vanaf MMS-plus 6, inclusief seismische lasten vanaf 10 mm
- Geoptimaliseerde betondraad met voldraad varianten voor de hoogste eisen
- Tot aan drie montagediepten voor meer flexibiliteit
- Machinaal te monteren en direct belastbaar
- Montagevriendelijk schroefanker ook bij zwaar versleten boren

De voordelen in metselwerk

- Met ETA-goedkeuring (ETA-20/0132)
- Goedgekeurd voor baksteen, massieve kalkzandsteen, holle kalkzandsteen en licht beton
- Toegestaan voor brandbelasting in metselwerk
- Optimale schroefdraad voor veilig en snel bevestigen in metselwerk
- Montage zonder reiniging van het boorgat toegestaan
- Twee zetdieptes voor meer flexibiliteit
- Eenvoudig te monteren en direct belastbaar

Het origineel onder de zelfsnijdende schroefankers voor beton en metselwerk!

Kopstempeling

Voor eenvoudige identificatie van het anker, ook na de montage

MMS-plus schroefdraad

Voor maximale belasting en duurzame constructies



▶ Video



▶ Video

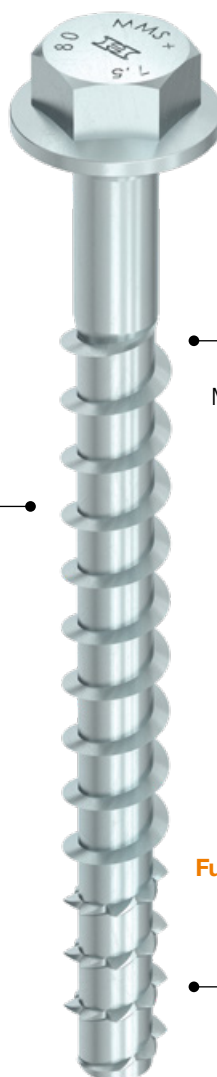

Ideale kern/draad geometrie
Maakt eenvoudig inschroeven en hoge draagkrachten mogelijk

Functionele punt met vertanding

Reduceert slijtage en maakt zo meervoudig gebruik bij tijdelijke bevestigingen mogelijk



Toepassingsvoorbeelden



Montage voor ondersteuning



Buismontage

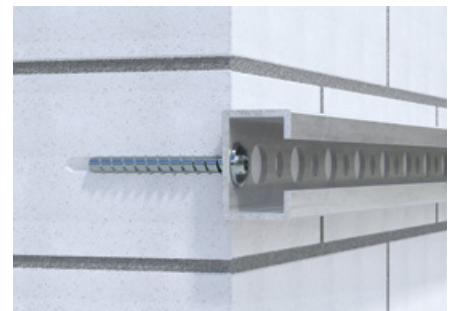

Montage van montagerails



Bevestiging van kabelschachten



Leuningbevestiging



Bevestiging van waterinstallaties

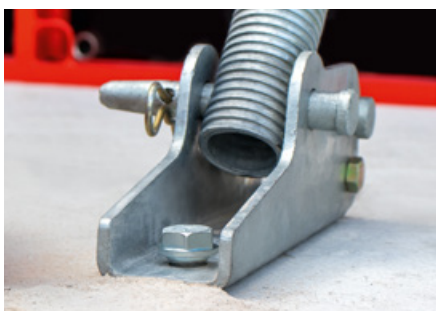

Schoren- en bekistingsmontage

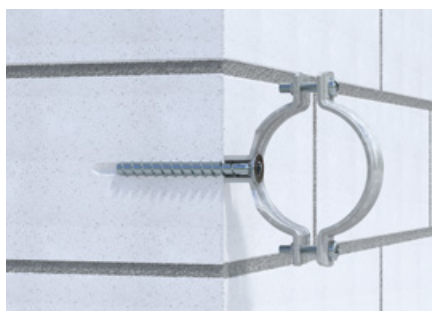

Montage van buisbeugels

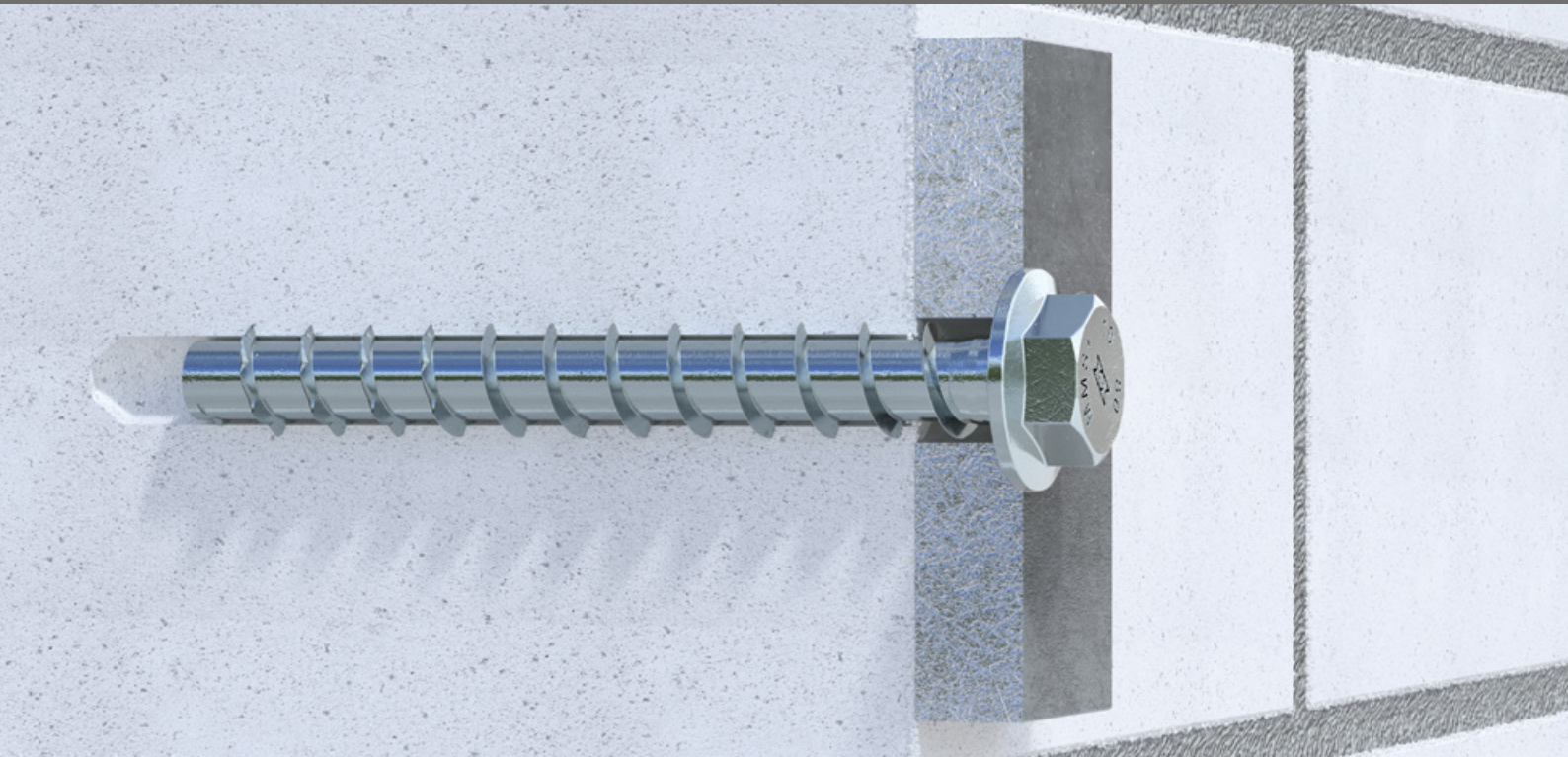

Aanvullende kopuitvoeringen



Platverzonken kop

Voor vlak en correct verzinken

Platte rondkop

Voor de bevestiging van montagerails

Rondkop

Voor het correct aandrukken van een montageonderdeel

Drempelanker

Voor maximaal 245 mm hoge drempels



Stokanker

Met metrisch buitendraad

Voorsteekanker

Met metrisch buitendraad

Binnendraadanker

Met metrisch binnenschroefdraad

172

Goedkeuringen



ETA-05/0010 – Verankering in gescheurd en ongescheurd beton (MULTI-MONTI)



ETA-15/0784 – Verankering in gescheurd en ongescheurd beton (MULTI-MONTI-plus)



ETA-15/0785 – Gebruik in beton voor redundante niet dragende systemen



ETA-20/0132 – Verankering in metselwerk, inclusief brandbelasting



ETA-23/0078 – Composietankerschroef voor gebruik in beton, seismische cat. C1 & C2



Seismische categorie C1 & C2 – geschikt voor regio's met seismische risico's



Brandwerendheidsklasse R120 – in ETA's 15/0784, 15/0785, 05/0010 en 20/0132

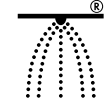

Sprinklerinstallaties – aan eisen van de VdS-richtlijn CEA 4001 wordt voldaan



Z-21.1-1879 – verankering van houten onderdelen in gescheurd en ongescheurd beton



Z-21.8-2061 – Hergebruik bij tijdelijke bevestigingen in vers beton



© Kasail GmbH

Voor bevestigingen in beton

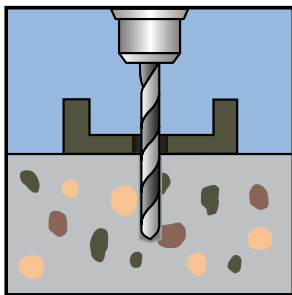

1. Boren

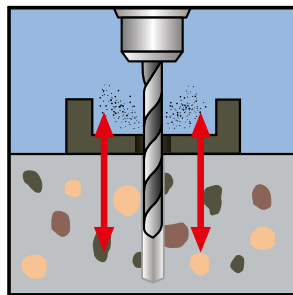

2. Boorgat schoonmaken

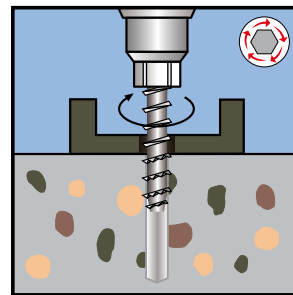

3. Inschroeven

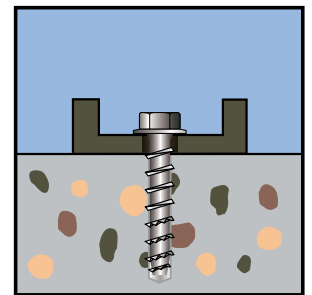

4. Klaar

173

Voor bevestigingen in metselwerk

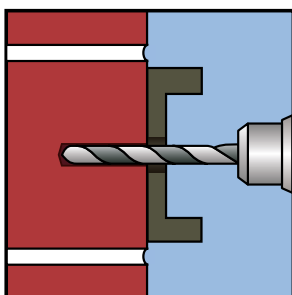

1. Boorgat maken (klopboor)

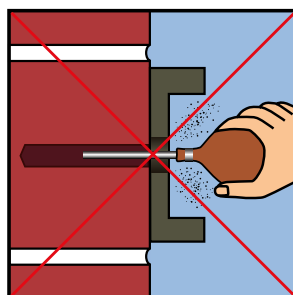

2. Boormeel hoeft niet te worden verwijderd!

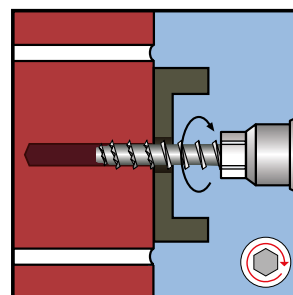

3. Inschroeven (schroefboormachine)

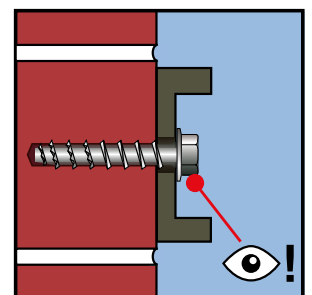

4. Erop letten dat kop goed aansluit → Klaar.



Uitvoering: MMS-plus SS, zeskantkop met aangepaste ring

Aandrijving: zeskantkop

Materiaal: koolstofstaal

Oppervlakte: verzinkt blauw, A2K **CHROME (VI) FREE** +

Kleurcode op het
HECO-etiket

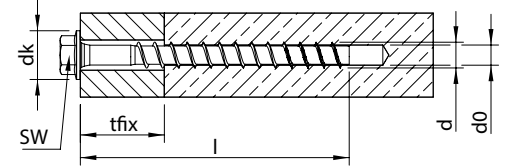

Afmeting d x l [mm]	Boor-Ø d ₀ [mm]	Klemdikte t _{kl} [mm]	Kopdiameter d _k [mm]	Aandrijving	ETA	Artikel- nummer	Aantal per verpakking [st.]	Type verpakking	Aantal per om- verpakking [st.]	
6,0	40	5,0	5/(15)	11,0	SW-8	•	48381	100	O-BOX	1.000
	50	5,0	5/15/(25)	11,0	SW-8	•	48383	100	O-BOX	1.000
	60	5,0	15/25/(35)	11,0	SW-8	•	48385	100	O-BOX	1.000
	70	5,0	25/35/(45)	11,0	SW-8	•	48387	100	O-BOX	1.000
	80	5,0	35/45/(55)	11,0	SW-8	•	49816	50	O-BOX	500
7,5	35	6,0	1/(10)	14,0	SW-10	•	49846	100	O-BOX	1.000
	40	6,0	5/(15)	14,0	SW-10	•	48389	100	O-BOX	1.000
	50	6,0	15/(25)	14,0	SW-10	•	48391	50	O-BOX	500
	60	6,0	5/25/(35)	14,0	SW-10	•	48393	50	O-BOX	500
	70	6,0	15/35/(45)	14,0	SW-10	•	48395	50	O-BOX	500
	80	6,0	25/45/(55)	14,0	SW-10	•	48397	50	O-BOX	500
	100	6,0	45/65/(75)	14,0	SW-10	•	49817	50	O-BOX	500
	120	6,0	65/85/(95)	14,0	SW-10	•	49819	50	O-BOX	400
10,0	140	6,0	85/105/(115)	14,0	SW-10	•	49821	50	O-BOX	400
	60	8,0	10	19,0	SW-13	•	48399	25	O-BOX	250
	70	8,0	5/20	19,0	SW-13	•	48401	25	O-BOX	250
	80	8,0	15/30	19,0	SW-13	•	48403	25	O-BOX	250
	90	8,0	25/40	19,0	SW-13	•	48405	25	O-BOX	250
	100	8,0	35/50	19,0	SW-13	•	48453	25	O-BOX	250
	120	8,0	55/70	19,0	SW-13	•	48455	25	O-BOX	200
	140	8,0	75/90	19,0	SW-13	•	48457	25	O-BOX	200
12,0	160	8,0	95/110	19,0	SW-13	•	48459	25	O-BOX	200
	60	10,0	5	22,0	SW-15	•	54277	25	O-BOX	250
	80	10,0	5	22,0	SW-15	•	48407	25	O-BOX	100
	90	10,0	1/15	22,0	SW-15	•	48409	25	O-BOX	100
	100	10,0	10/25	22,0	SW-15	•	48411	25	O-BOX	100
	120	10,0	30/45	22,0	SW-15	•	48413	25	O-BOX	100
	140	10,0	50/65	22,0	SW-15	•	48415	25	O-BOX	100
160	10,0	70/85	22,0	SW-15	•	48461	25	O-BOX	100	

* (...) = t_{kl}-waarden tussen haakjes gelden alleen bij het gebruik van de schroeven in redundante, niet-dragende systemen (zie ETA-15/0785)

¹ Geldt alleen voor varianten met diameter 10–12 mm. C2 alleen in combinatie met seismische kit (ETA-23/0078), zie pagina 196.

² Geldt alleen voor varianten met diameter 6–10 mm

Uitvoering: MMS-SS, zeskantkop met aangepaste ring

Aandrijving: zeskantkop

Materiaal: koolstofstaal

Oppervlakte: verzinkt blauw, A2K **CHROME (VI) FREE +**

Kleurcode op het HECO-etiket

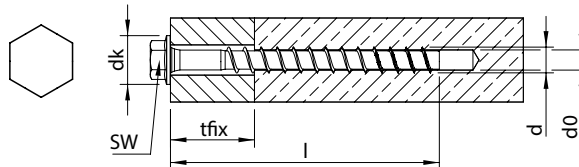
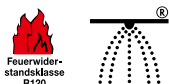

Afmeting d x l [mm]	Boor-Ø d ₀ [mm]	Klemdikte t _{fix} [mm]	Kopdiameter d _k [mm]	Aandrijving	ETA	Artikelnummer	Aantal per verpakking [st.]	Type verpakking	Aantal per omverpakking [st.]	
14,0	110	12,0	15	26,0	SW-17	●	54271	25	O-BOX	100
	130	12,0	35	26,0	SW-17	●	54272	25	O-BOX	100
	150	12,0	55	26,0	SW-17	●	54273	25	O-BOX	100

Uitvoering: MMS-plus SS, zeskantkop met aangepaste ring

Aandrijving: zeskantkop

Materiaal: koolstofstaal

Oppervlakte: HP-coating **CHROME (VI) FREE +**

Kleurcode op het HECO-etiket

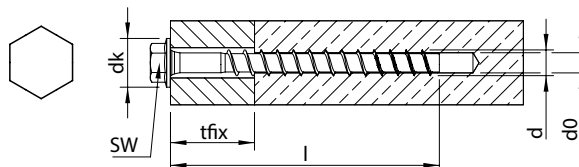

Afmeting d x l [mm]	Boor-Ø d ₀ [mm]	Klemdikte t _{fix} [mm]	Kopdiameter d _k [mm]	Aandrijving	ETA	Artikelnummer	Aantal per verpakking [st.]	Type verpakking	Aantal per omverpakking [st.]	
6,0	50	5,0	5/15/(25)	11,0	SW-8	●	48429	100	O-BOX	1.000
	60	5,0	15/25/(35)	11,0	SW-8	●	48431	100	O-BOX	1.000
7,5	50	6,0	15/(25)	14,0	SW-10	●	48433	50	O-BOX	500
	60	6,0	5/25/(35)	14,0	SW-10	●	48435	50	O-BOX	500
	70	6,0	15/35/(45)	14,0	SW-10	●	48437	50	O-BOX	500
10,0	60	8,0	10	19,0	SW-13	●	48439	25	O-BOX	250
	70	8,0	5/20	19,0	SW-13	●	48441	25	O-BOX	250
	80	8,0	15/30	19,0	SW-13	●	48443	25	O-BOX	250
	90	8,0	25/40	19,0	SW-13	●	48445	25	O-BOX	250
12,0	90	10,0	1/15	22,0	SW-15	●	48447	25	O-BOX	100
	100	10,0	10/25	22,0	SW-15	●	48449	25	O-BOX	100
	120	10,0	30/45	22,0	SW-15	●	48451	25	O-BOX	100

* (...) = t_{fix}-waarden tussen haakjes gelden alleen bij het gebruik van de schroeven in redundante, niet-dragende systemen (zie ETA-15/0785)

¹ Geldt alleen voor varianten met diameter 10–12mm. C2 alleen in combinatie met seismische kit (ETA-23/0078), zie pagina 196.

² Geldt alleen voor varianten met diameter 6–10mm



Uitvoering: MMS-plus S zwaarlastanker, zeskantkop

Aandrijving: zeskantkop

Materiaal: koolstofstaal

Oppervlakte: verzinkt blauw, A2K **CHROME (VI) FREE +**

Kleurcode op het HECO-etiket

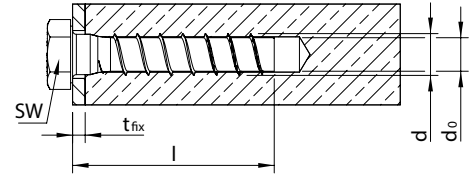

Afmeting d x l [mm]	Boor-Ø d ₀ [mm]	Klemdikte t _{fix} [mm]	Kopdiameter d _k [mm]	Aandrijving	ETA	Artikelnummer	Aantal per verpakking [st.]	Type verpakking	Aantal per omverpakking [st.]
16,0	80	14,0	5	24,0	SW-24	54274	25	O-BOX	100



Uitvoering: MMS-plus SS zwaarlastanker, zeskantkop met aangepaste ring

Aandrijving: zeskantkop

Materiaal: koolstofstaal

Oppervlakte: verzinkt blauw, A2K **CHROME (VI) FREE +**

Kleurcode op het HECO-etiket

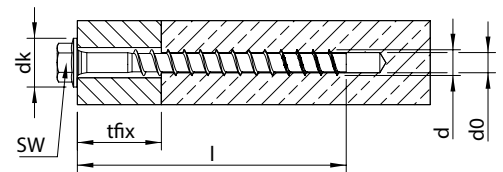

Afmeting d x l [mm]	Boor-Ø d ₀ [mm]	Klemdikte t _{fix} [mm]	Kopdiameter d _k [mm]	Aandrijving	ETA	Artikelnummer	Aantal per verpakking [st.]	Type verpakking	Aantal per omverpakking [st.]
16,0	120	14,0	5/20	30,0	SW-21	● 49848	10	O-BOX	40
	130	14,0	15/30	30,0	SW-21	● 48417	10	O-BOX	40
	140	14,0	25/40	30,0	SW-21	● 48419	10	O-BOX	40
	160	14,0	45/60	30,0	SW-21	● 48421	10	O-BOX	40
20,0	100	18,0	10	38,0	SW-24	● 54275	10	O-BOX	40
	130	18,0	15	38,0	SW-24	● 54276	10	O-BOX	40
	160	18,0	20	38,0	SW-24	● 48423	6	O-BOX	24
	180	18,0	40	38,0	SW-24	● 48425	6	O-BOX	24
	200	18,0	60	38,0	SW-24	● 48427	6	O-BOX	24

Uitvoering: MMS-plus S, zeskantkop, met sluitring DIN 440

Aandrijving: zeskantkop

Materiaal: koolstofstaal

Oppervlakte: verzinkt blauw, A2K **CHROME (VI) FREE +**

Kleurcode op het HECO-etiket

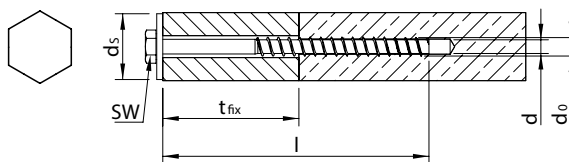

Afmeting d x l [mm]	Boor-Ø d ₀ [mm]	Klemdikte t _{fix} [mm]	Ringdiameter d _s [mm]	Aandrijving	ETA	Artikelnummer	Aantal per verpakking [st.]	Type verpakking	Aantal per omverpakking [st.]	
12,0	180	10,0	90/105	44,0	SW-19	●	48463	25	O-BOX	50
	200	10,0	110/125	44,0	SW-19	●	48465	25	O-BOX	50
	240	10,0	150/165	44,0	SW-19	●	48467	25	O-BOX	50
	280	10,0	190/205	44,0	SW-19	●	48469	25	O-BOX	50
	320	10,0	230/245	44,0	SW-19	●	48471	25	O-BOX	50



Uitvoering: MMS-plus V, Voorsteekanker met metr. buitendraad

Aandrijving: zeskantkop

Materiaal: koolstofstaal

Oppervlakte: verzinkt blauw, A2K **CHROME (VI) FREE** +

Kleurcode op het HECO-etiket

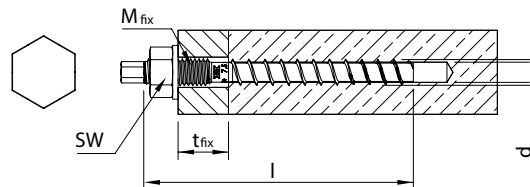

Afmeting d x l [mm]	Boor-Ø d _o [mm]	Klemdikte t _{kl} [mm]	Metrisch buitendraad M _{fix}	Aandrijving	ETA	Artikelnummer	Aantal per verpakking [st.]	Type verpakking	Aantal per omverpakking [st.]	
7,5	80	6,0	15/35/(45)	M8x20	SW-5,5	●	48668	50	O-BOX	500
	100	6,0	35/55/(65)	M8x40	SW-5,5	●	48670	50	O-BOX	500
10,0	90	8,0	15/30	M10x20	SW-7	●	48672	25	O-BOX	250
	110	8,0	35/50	M10x40	SW-7	●	48674	25	O-BOX	250
	130	8,0	55/70	M10x60	SW-7	●	48676	25	O-BOX	200
12,0	110	10,0	25	M12x30	SW-8	●	48678	25	O-BOX	100
	120	10,0	20/35	M12x25	SW-8	●	48680	25	O-BOX	100
	140	10,0	40/55	M12x45	SW-8	●	48682	25	O-BOX	100

* (...) = t_{kl}-waarden tussen haakjes gelden alleen bij het gebruik van de schroeven in redundante, niet-dragende systemen (zie ETA-15/0785)

¹ Geldt alleen voor varianten met diameter 10–12 mm ² Geldt alleen voor varianten met diameter 7,5–10 mm

178



Uitvoering: MMS-plus V, zwaarlast-voorsteekanker met metrisch buitendraad

Aandrijving: zeskantkop

Materiaal: koolstofstaal

Oppervlakte: verzinkt blauw, A2K **CHROME (VI) FREE** +

Kleurcode op het HECO-etiket

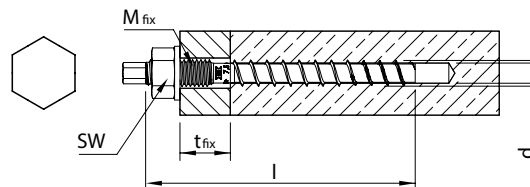

Afmeting d x l [mm]	Boor-Ø d _o [mm]	Klemdikte t _{kl} [mm]	Metrisch buitendraad M _{fix}	Aandrijving	ETA	Artikelnummer	Aantal per verpakking [st.]	Type verpakking	Aantal per omverpakking [st.]	
16,0	150	14,0	20/35	M16x40	SW-12	●	48684	10	O-BOX	40
	200	14,0	70/85	M16x75	SW-12	●	48686	10	O-BOX	40
20,0	190	18,0	30	M20x40	SW-15	●	48688	6	O-BOX	24
	220	18,0	60	M20x70	SW-15	●	48690	6	O-BOX	24

Uitvoering: MMS-plus F, platverzonken kop

Aandrijving: T-Drive

Materiaal: koolstofstaal

Oppervlakte: verzinkt blauw, A2K **CHROME (VI) FREE +**

Kleurcode op het HECO-etiket

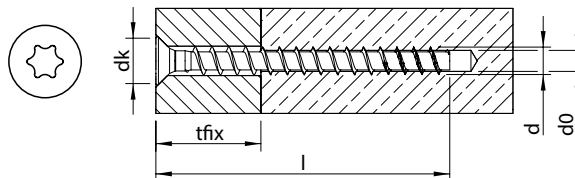

Afmeting d x l [mm]	Boor-Ø d ₀ [mm]	Klemdikte t _{kl} [mm]	Kopdiameter d _k [mm]	Aandrijving	ETA	Artikelnummer	Aantal per verpakking [st.]	Type verpakking	Aantal per omverpakking [st.]
5,0 ★	30	4,0	1	8,7	T-25	54264	200	O-BOX	2.000
	40	4,0	5	8,7	T-25	54265	200	O-BOX	2.000
	50	4,0	15	8,7	T-25	54266	200	O-BOX	2.000
	60	4,0	25	8,7	T-25	54267	200	O-BOX	2.000
6,0 ★	40	5,0	5/(15)	11,5	T-30	● 49860	100	O-BOX	1.000
	50	5,0	5/15/(25)	11,5	T-30	● 48495	100	O-BOX	1.000
	60	5,0	15/25/(35)	11,5	T-30	● 48497	100	O-BOX	1.000
	70	5,0	25/35/(45)	11,5	T-30	● 48499	100	O-BOX	1.000
	80	5,0	35/45/(55)	11,5	T-30	● 48501	50	O-BOX	500
	100	5,0	55/65/(75)	11,5	T-30	● 48503	50	O-BOX	500
	120	5,0	75/85/(95)	11,5	T-30	● 48505	50	O-BOX	500
	140	5,0	95/105/(115)	11,5	T-30	● 48507	50	O-BOX	500
7,5 ★	45	6,0	10/(20)	15,5	T-40	● 49862	100	O-BOX	1.000
	50	6,0	15/(25)	15,5	T-40	● 48509	100	O-BOX	1.000
	60	6,0	5/25/(35)	15,5	T-40	● 48511	50	O-BOX	500
	70	6,0	15/35/(45)	15,5	T-40	● 48513	50	O-BOX	500
	80	6,0	25/45/(55)	15,5	T-40	● 48515	50	O-BOX	500
	100	6,0	45/65/(75)	15,5	T-40	● 48517	50	O-BOX	500
	120	6,0	65/85/(95)	15,5	T-40	● 48519	50	O-BOX	400
	140	6,0	85/105/(115)	15,5	T-40	● 48521	50	O-BOX	400
	160	6,0	105/125/(135)	15,5	T-40	● 48523	50	O-BOX	400
10,0 ★	60	8,0	10	19,5	T-45	● 48525	25	O-BOX	250
	70	8,0	5/20	19,5	T-45	● 48527	25	O-BOX	250
	80	8,0	15/30	19,5	T-45	● 48529	25	O-BOX	250
12,0 ★	90	10,0	15	24,0	T-50	● 48531	25	O-BOX	100
	100	10,0	10/25	24,0	T-50	● 48533	25	O-BOX	100
	120	10,0	30/45	24,0	T-50	● 48535	25	O-BOX	100

* (...) = t_{kl}-waarden tussen haakjes gelden alleen bij het gebruik van de schroeven in redundante, niet-dragende systemen (zie ETA-15/0785)

¹ Geldt alleen voor varianten met diameter 10–12 mm ² Geldt alleen voor varianten met diameter 6–10 mm



Uitvoering: MMS-plus MS, Montagerailschroef met platte rondkop

Aandrijving: T-Drive

Materiaal: koolstofstaal

Oppervlakte: verzinkt blauw, A2K **CHROME (VI) FREE** +

Kleurcode op het HECO-etiket

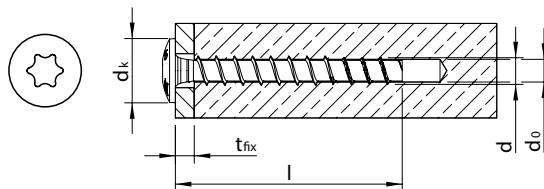

Afmeting d x l [mm]	Boor-Ø d ₀ [mm]	Klemdikte t _{fix} [mm]	Kopdiameter d _k [mm]	Aandrijving	ETA	Artikelnummer	Aantal per verpakking [st.]	Type verpakking	Aantal per omverpakking [st.]	
7,5 ★	35	6,0	1/(10)	17,0	T-30	●	49827	100	O-BOX	1.000
	40	6,0	5/(15)	17,0	T-30	●	49854	100	O-BOX	1.000
	45	6,0	10/(20)	17,0	T-30	●	49829	100	O-BOX	1.000
	50	6,0	15/(25)	17,0	T-30	●	49856	100	O-BOX	1.000
	60	6,0	5/25/(35)	17,0	T-30	●	52374	50	O-BOX	500

* (...) = t_{fix}-waarden tussen haakjes gelden alleen bij het gebruik van de schroeven in redundante, niet-dragende systemen (zie ETA-15/0785)

Uitvoering: MMS-plus ST, Stokanker met metr. buitendraad

Aandrijving: zeskantkop

Materiaal: koolstofstaal

Oppervlakte: verzinkt blauw, A2K **CHROME (VI) FREE +**

Kleurcode op het HECO-etiket

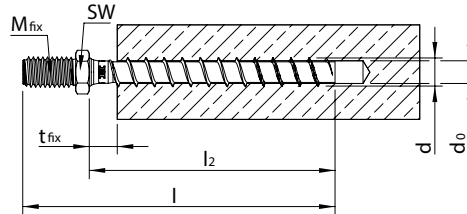

Afmeting d x l [mm]	Boor-Ø d ₀ [mm]	Nuttige lengte l ₂ [mm]	Klemdikte t _{fix} [mm]	Kopdiameter d ₀ [mm]	Aandrijving	ETA	Artikelnummer	Aantal per verpakking [st.]	Type verpakking	Aantal per omverpakking [st.]
6,0	55	5,0	45	1/10/(20)	10,0	SW-10	● 48654	100	O-BOX	1.000
	65	5,0	55	10/20/(30)	10,0	SW-10	● 48656	50	O-BOX	500
7,5	50	6,0	36	1/(11)	10,0	SW-10	● 57262	50	O-BOX	500
	60	6,0	43	8/(18)	10,0	SW-10	● 48658	50	O-BOX	500
	70	6,0	53	18/(28)	10,0	SW-10	● 48660	50	O-BOX	500
	80	6,0	63	8/28/(38)	10,0	SW-10	● 48662	50	O-BOX	500
	100	6,0	83	28/48/(58)	10,0	SW-10	● 48664	50	O-BOX	500
	120	6,0	103	48/68/(78)	10,0	SW-10	● 49831	50	O-BOX	400
10,0	75	8,0	60	10	13,0	SW-13	● 49858	25	O-BOX	250
	85	8,0	70	5/20	13,0	SW-13	● 48666	25	O-BOX	250

* (...) = t_{fix}-waarden tussen haakjes gelden alleen bij het gebruik van de schroeven in redundante, niet-dragende systemen (zie ETA-15/0785)

¹ Geldt alleen voor varianten met diameter 10 mm

MMS-plus ST 6,0: met metrisch buitendraad M6 x 5 mm

MMS-plus ST 7,5: met metrisch buitendraad M8 x 14 mm

MMS-plus ST 10,0: met metrisch buitendraad M10 x 11 mm



Uitvoering: MMS-plus I, Binnendraadanker

Aandrijving: zeskantkop

Materiaal: koolstofstaal

Oppervlakte: verzinkt blauw, A2K **CHROME (VI) FREE** +

Kleurcode op het HECO-etiket

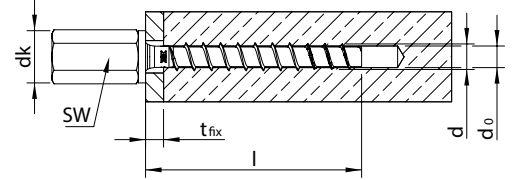

Afmeting d x l [mm]	Boor-Ø d ₀ [mm]	Klemdikte t _{fix} [mm]	Kopdiameter d _k [mm]	Aandrijving	ETA	Artikelnummer	Aantal per verpakking [st.]	Type verpakking	Aantal per omverpakking [st.]
6,0	40	5,0	5/(15)	11,0	SW-10	● 48692	100	O-BOX	1.000
7,5	40	6,0	5/(15)	14,5	SW-13	● 49833 **	40	O-BOX	400
	40	6,0	5/(15)	14,5	SW-13	● 48696	50	O-BOX	500
	60	6,0	5/25/(35)	14,5	SW-13	● 49834 **	40	O-BOX	400
	60	6,0	5/25/(35)	14,5	SW-13	● 48698	50	O-BOX	500
10,0	60	8,0	10	19,5	SW-13	● 48700	25	O-BOX	250
	75	8,0	10/25	19,5	SW-13	● 48702	25	O-BOX	250

* (...) = t_{fix}-waarden tussen haakjes gelden alleen bij het gebruik van de schroeven in redundante, niet-dragende systemen (zie ETA-15/0785)

** gecombineerde schroefdraad M8/M10 x 23mm

¹ Geldt alleen voor varianten met diameter 10mm

MMS-plus I 6,0: met metrisch buitendraad M6 x 15mm

MMS-plus I 7,5: met metrisch buitendraad M8 x 12mm

MMS-plus I 10,0: met metrisch buitendraad M10 x 13mm

Uitvoering: MMS-plus P, rondkop (PanHead)

Aandrijving: T-Drive

Materiaal: koolstofstaal

Oppervlakte: verzinkt blauw, A2K **CHROME (VI) FREE +**

Kleurcode op het HECO-etiket

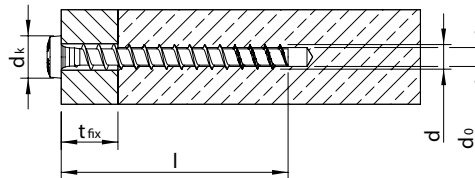

Afmeting d x l [mm]	Boor-Ø d ₀ [mm]	Klemdikte t _{cl} [mm]	Kopdiameter d _k [mm]	Aandrijving	ETA	Artikelnummer	Aantal per verpakking [st.]	Type verpakking	Aantal per omverpakking [st.]
5,0	30	4,0	1	7,9	T-20	54268	200	O-BOX	2.000
	50	4,0	15	7,9	T-20	54269	200	O-BOX	2.000
6,0	30	5,0	1/(5)	11,2	T-30	54278	200	O-BOX	2.000
	35	5,0	1/(10)	11,0	T-30	49850	100	O-BOX	1.000
	40	5,0	5/(15)	11,0	T-30	48483	100	O-BOX	1.000
	50	5,0	5/15/(25)	11,0	T-30	48485	100	O-BOX	1.000
7,5	60	5,0	15/25/(35)	11,0	T-30	48487	100	O-BOX	1.000
	25	6,0	1	14,5	T-30	54279	200	O-BOX	2.000
	35	6,0	1/(10)	14,5	T-30	49852	100	O-BOX	1.000
	40	6,0	5/(15)	14,5	T-30	48489	100	O-BOX	1.000
10,0	50	6,0	15/(25)	14,5	T-30	48491	100	O-BOX	500
	60	6,0	5/25/(35)	14,5	T-30	48493	50	O-BOX	500
	60	8,0	10	19,5	T-40	49823	25	O-BOX	250
	70	8,0	5/20	19,5	T-40	49825	25	O-BOX	250

* (...) = t_{cl}-waarden tussen haakjes gelden alleen bij het gebruik van de schroeven in redundante, niet-dragende systemen (zie ETA-15/0785)

¹ Geldt alleen voor varianten met diameter 10 mm. C2 alleen in combinatie met seismische kit (ETA-23/0078), zie pagina 196.



Uitvoering: MMS-plus KS, Kabelklemschroef

Aandrijving: T-Drive

Materiaal: koolstofstaal

Oppervlakte: verzinkt blauw, A2K **CHROME (VI) FREE +**

Kleurcode op het HECO-etiket

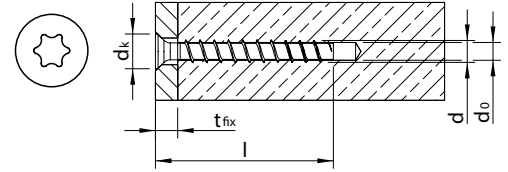

Afmeting d x l [mm]	Boor-Ø d ₀ [mm]	Klemdikte t _{fix} [mm]	Kopdiameter d _k [mm]	Aandrijving	ETA	Artikelnummer	Aantal per verpakking [st.]	Type verpakking	Aantal per omverpakking [st.]
5,0 ¹	40	4,0	5	7,8	T-20	54270	200	O-BOX	2.000

¹ Kleurcodering T-20-Bit =



Uitvoering: MMS-plus R, Ooganker

Aandrijving: zetgereedschap*

Materiaal: koolstofstaal

Oppervlakte: verzinkt blauw, A2K **CHROME (VI) FREE +**

Kleurcode op het HECO-etiket

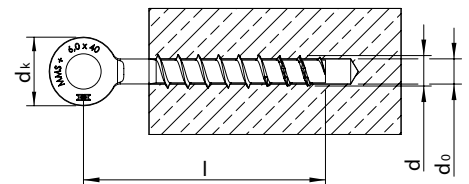

Afmeting d x l [mm]	Boor-Ø d ₀ [mm]	Klemdikte t _{fix} [mm]	Kopdiameter d _k [mm]	Aandrijving	ETA	Artikelnummer	Aantal per verpakking [st.]	Type verpakking	Aantal per omverpakking [st.]
6	40	5,0	-	14,0	-	54280	200	O-BOX	2.000

* Zetgereedschap is bijgevoegd

MULTI-MONTI® TimberConnect

Productinformatie

- Voor het veilig bevestigen van houten onderdelen aan beton
- Snel en eenvoudig machinaal zetbaar, geen specifiek aandraaimoment nodig
- Geen uithardingstijden: de verbinding is onmiddellijk belastbaar
- Drie afmetingen voor houten aanbouwdelen van 40 mm tot 300 mm
- Transmissie van hoge trek- en schuifkrachten zonder extra ontwerpinspanning
- Maakt montagepunten vlak met het oppervlak mogelijk
- Veilig in gebruik, geen verborgen installatiefouten mogelijk
- Goedgekeurd en gecontroleerd product



Het unieke anker met dubbele schroefdraad voor bevestiging van houten onderdelen aan beton

Kleine verzonken cilinderkop

Kan moeiteloos in het hout worden verzonken en kan dus flexibel worden gebruikt in verschillende houtdiktes

Betondraad

Zorgt voor krachtige verankering verankering in beton

Houtdraad

Zorgt voor een stevige bevestiging van het houten aanbouwdeel

Vertande functionele punt

Maakt snelle en eenvoudige montage mogelijk



Uitvoering: MMS-TC TimberConnect

Aandrijving: T-Drive

Materiaal: koolstofstaal

Oppervlakte: verzinkt blauw, A2K **CHROME (VI) FREE** +

Kleurcode op het HECO-etiket

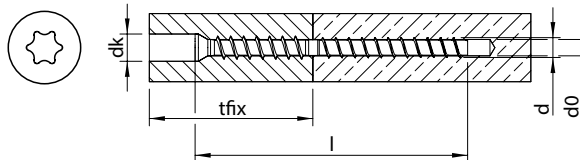

Afmeting d x l [mm]	Boor-Ø d _b [mm]	Klemdikte t _{kl} [mm]	Kopdiameter d _k [mm]	Aandrijving	ETA	Artikelnummer	Aantal per verpakking [st.]	Type verpakking	Aantal per omverpakking [st.]	
7,5¹	100	6,0	40–140	10,0	T-30	●	48308	50	O-BOX	500
10,0²	130	8,0	60–200	16,0	T-45	●	48310	25	O-BOX	250
12,0³	160	10,0	80–300	17,5	T-50	●	48312	25	O-BOX	100

Het bijbehorende zetgereedschap vindt u op pagina 190

¹ Kleurcodering T-30-Bit = ● ² Kleurcodering T-45-Bit = ● ³ Kleurcodering T-50-Bit = ●

De juiste montage

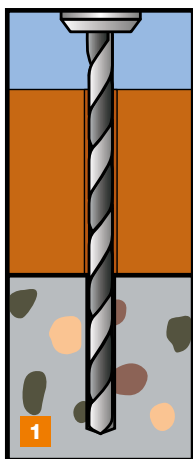

1. Boren

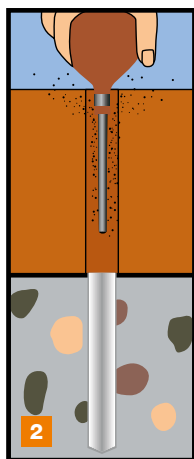

2. Boorgat schoonmaken

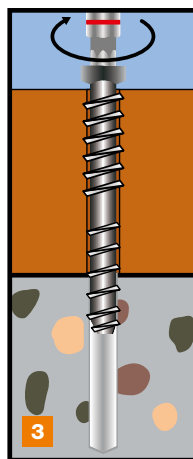

3. Inschroeven

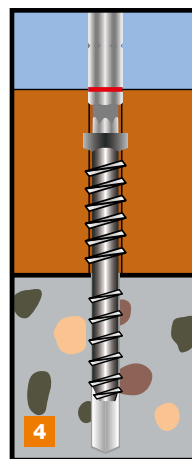

4. Klaar



▶ Video

MULTI-MONTI®-plus SSK Schoorenanker

Productinformatie

- Tijdelijke bevestiging van bouwplaatsinrichtingen zoals bijv. bouwstempels, schoren, valbeveiliging en steigerbouw
- Demonteerbaar en herbruikbaar met gebruik van een meethuls
- Goedgekeurd voor gebruik in jong beton bij een betondruksterkte $f_{c,cube} > 10 \text{ N/mm}^2$
- Gatdiameter van 17 – 23 mm in de grondplaat met één schroef herbruikbaar
- Machinaal zetbaar, geen specifiek aandraaimoment nodig
- Veilig in gebruik, geen verborgen montagefouten mogelijk
- Goedgekeurd en bewaakt product



Het innovatieve schroefanker voor bevestiging van schoren in jong beton

Kopstempeling

Voor een eenvoudige indentificatie van het anker, ook na montage

Ideale kern/ schroefdraad geometrie

Maakt eenvoudig inschroeven en hoge draagkrachten mogelijk

Conus onder de kop

Past zich aan verschillende gatdiameters aan



Vertande functionele punt

Reduceert slijtage door de grotere buitendiameter en de versterkte vertanding

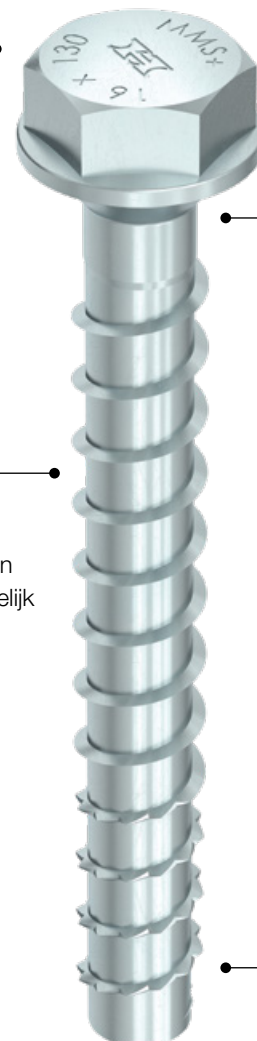

Uitvoering: MMS-plus SSK, Schorenanker, zeskantkop met aangepaste ring en conus

Aandrijving: zeskantkop

Materiaal: koolstofstaal

Oppervlakte: verzinkt blauw, A2K **CHROME (VI) FREE +**

Kleurcode op het HECO-etiket

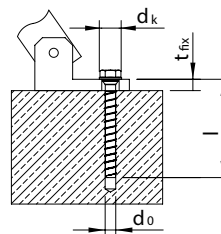

Afmeting d x l [mm]	Boor-Ø d _o [mm]	Klemdikte t _{fix} [mm]	Kopdiameter d _k [mm]	Aandrijving	ETA	Artikelnummer	Aantal per verpakking [st.]	Type verpakking	Aantal per omverpakking [st.]
16,0	90	14,0	15	30,0	SW-24	57286	10	O-BOX	40
	130	14,0	15/30	30,0	SW-24	53794	10	O-BOX	40

Het bijbehorende meethulzen vindt u op pagina 199

Herbruikbaarheidstest



Dankzij de **HECO-meethulzen** (artikelnummer 47794) met **diameter 16**, kan de schroef bij tijdelijke bevestigingen altijd op de herbruikbaarheid getest worden.

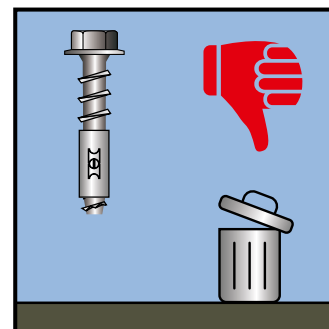
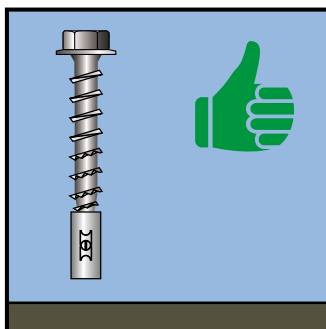

MULTI-MONTI®-plus Therm

Productinformatie

- Voor het bevestigen van tengels op beton op geïsoleerde daken en gevels
- Kan worden gebruikt voor alle gebruikelijke isolatiematerialen zonder eisen aan de druksterkte
- Tot drie montage diepten voor meer flexibiliteit
- Kan snel en eenvoudig machinaal worden gemonteerd, geen gedefinieerd aandraaimoment vereist
- Veilig in gebruik, geen verborgen installatiefouten mogelijk



Het ideale schroefanker voor het bevestigen van tengels op beton op geïsoleerde daken en gevels

Gilinderkop

Voor spleetvrije installatie in het houten aanbouwdeel

Onderkopdraad

Voor een veilige bevestiging van de tengel

Betondraad

Zorgt voor een krachtige verankering in beton

Vertande functionele punt

Maakt snelle en eenvoudige installatie mogelijk



Uitvoering: MMS-plus Therm, cilinderkop

Aandrijving: T-Drive

Materiaal: koolstofstaal

Oppervlakte: verzinkt blauw, A2K **CHROME (VI) FREE +**

Kleurcode op het
HECO-etiket

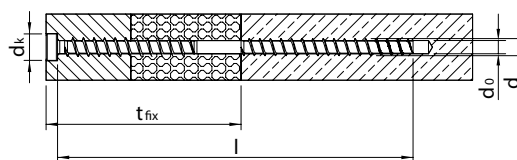

Afmeting d x l [mm]	Boor-Ø d ₀ [mm]	Klemdikte t _{fix} [mm]	Kopdiameter d _k [mm]	Aandrijving	ETA	Artikel- nummer	Aantal per verpakking [st.]	Type verpakking	Aantal per om- verpakking [st.]	
7,5 	180	6,0	125/145/(155)	12,0	T-40	●	64059	50	O-BOX	200
	200	6,0	145/165/(175)	12,0	T-40	●	64060	50	O-BOX	200
	220	6,0	165/185/(195)	12,0	T-40	●	64061	50	O-BOX	200
	240	6,0	185/205/(215)	12,0	T-40	●	64062	50	O-BOX	200
	260	6,0	205/225/(235)	12,0	T-40	●	64063	50	O-BOX	200
	280	6,0	225/245/(255)	12,0	T-40	●	64064	50	O-BOX	200
	300	6,0	245/265/(275)	12,0	T-40	●	64065	50	O-BOX	200
	320	6,0	265/285/(295)	12,0	T-40	●	64066	50	O-BOX	200
	340	6,0	285/305/(315)	12,0	T-40	●	64067	50	O-BOX	200

* (...) = t_{fix}-waarden tussen haakjes gelden alleen bij het gebruik van de schroeven in redundante, niet-dragende systemen (zie ETA-15/0785)

MULTI-MONTI[®]-plus Roestvaststaal A4

Productinformatie

- Goedgekeurd en bewaakt product voor gescheurd en ongescheurd beton
- Tot 6 montage diepten voor maximale flexibiliteit
- Uitgebreid productassortiment voor verschillende toepassingen
- Verkrijgbaar in roestvrij staal A4 1.4401
- Roestvrij staal 1.4529 / HCR op aanvraag
- Geoptimaliseerd betonschroefdraad voor een krachtige verankering
- Het schroefanker met het hoogste montagecomfort



Het innovatieve schroefanker voor beton en metselwerk binnen en buiten

Kopstempeling

Voor eenvoudige identificatie van het anker, ook na de montage

MMS-plus schroefdraad

Voor maximale belasting en duurzame constructies

Ideale kern/draad geometrie

Maakt eenvoudig inschroeven en hoge draagkrachten mogelijk

Functionele punt gefosfateerd

Voor een zekere achtersnijding in het beton

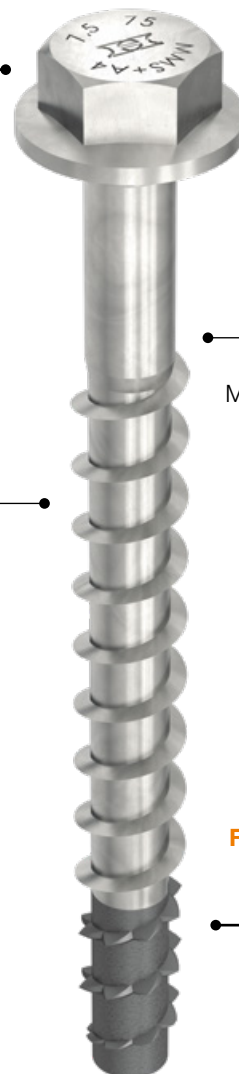

▶ Video



Uitvoering: MMS-plus SS, zeskantkop met aangepaste ring

Aandrijving: zeskantkop

Materiaal: roestvaststaal A4 1.4401

Oppervlakte: blank, punt gefosfateerd

Kleurcode op het HECO-etiket

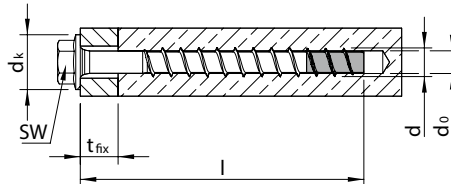

Afmeting d x l [mm]	Boor-Ø d ₀ [mm]	Klemdikte t _{fix, standard} * [mm]	Klemdikte t _{fix, reduced} * [mm]	Kopdiameter d ₀ [mm]	Aandrijving	ETA	Artikelnummer	Aantal per verpakking [st.]	Type verpakking	Aantal per omverpakking [st.]	
7,5	40	6,0	1	5	14,5	SW-10	●	56612	50	O-BOX	500
	45	6,0	5	10	14,5	SW-10	●	52805	50	O-BOX	500
	55	6,0	1/15	5/20	14,5	SW-10	●	56613	50	O-BOX	500
	65	6,0	10/25	1/15/30	14,5	SW-10	●	56616	50	O-BOX	500
	75	6,0	1/20/35	10/25/40	14,5	SW-10	●	52792	50	O-BOX	500
	85	6,0	10/30/45	20/35/50	14,5	SW-10	●	52793	50	O-BOX	500
	105	6,0	30/50/65	40/55/70	14,5	SW-10	●	52794	50	O-BOX	500
10,0	65	8,0	-	5	19,5	SW-13	●	56617	25	O-BOX	250
	75	8,0	5	1/15	19,5	SW-13	●	56618	25	O-BOX	250
	85	8,0	1/15	10/25	19,5	SW-13	●	56619	25	O-BOX	250
	95	8,0	10/25	20/35	19,5	SW-13	●	56620	25	O-BOX	250
	105	8,0	20/35	30/45	19,5	SW-13	●	56621	25	O-BOX	250
12,0	95	10,0	-	5	22,5	SW-15	●	56622	25	O-BOX	100
	105	10,0	5	1/15	22,5	SW-15	●	52801	25	O-BOX	100
	120	10,0	5/20	15/30	22,5	SW-15	●	52802	25	O-BOX	100
	135	10,0	20/35	30/45	22,5	SW-15	●	50252	25	O-BOX	100

* Klemdikte t_{fix, standard} en t_{fix, reduced} afhankelijk van de opgegeven draagkracht uit de ETA-15/0784



Uitvoering: MMS-plus F, platverzonken kop

Aandrijving: T-Drive

Materiaal: roestvaststaal A4 1.4401

Oppervlakte: blank, punt gefosfateerd

Kleurcode op het HECO-etiket

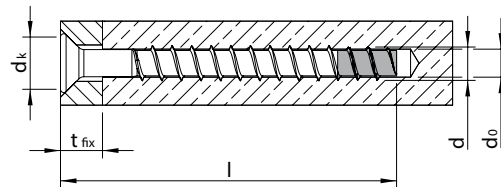

Afmeting d x l [mm]	Boor-Ø d ₀ [mm]	Klemdikte t _{fix, standard} * [mm]	Klemdikte t _{fix, reduced} * [mm]	Kopdiameter d ₀ [mm]	Aandrijving	ETA	Artikelnummer	Aantal per verpakking [st.]	Type verpakking	Aantal per omverpakking [st.]	
7,5 ★	40	6,0	1	5	13,6	T-30	●	56623	50	O-BOX	500
	45	6,0	5	10	13,6	T-30	●	52785	50	O-BOX	500
	55	6,0	1/15	5/20	13,6	T-30	●	56624	50	O-BOX	500
	65	6,0	10/25	1/15/30	13,6	T-30	●	56625	50	O-BOX	500
	75	6,0	1/20/35	10/25/40	13,6	T-30	●	52788	50	O-BOX	500
	85	6,0	10/30/45	20/35/50	13,6	T-30	●	52789	50	O-BOX	500
	95	6,0	20/40/55	30/45/60	13,6	T-30	●	53130	50	O-BOX	500
	105	6,0	30/50/65	40/55/70	13,6	T-30	●	52790	50	O-BOX	500
	125	6,0	50/70/85	60/75/90	13,6	T-30	●	52791	50	O-BOX	500
10,0 ★	65	8,0	-	5	17,0	T-40	●	56626	25	O-BOX	250
	80	8,0	10	5/20	17,0	T-40	●	56627	25	O-BOX	250
	90	8,0	5/20	15/30	17,0	T-40	●	56628	25	O-BOX	250
	100	8,0	15/30	25/40	17,0	T-40	●	56629	25	O-BOX	250
12,0 ★	95	10,0	-	5	21,0	T-50	●	56630	25	O-BOX	100
	105	10,0	5	1/15	21,0	T-50	●	56631	25	O-BOX	100
	120	10,0	5/20	15/30	21,0	T-50	●	56632	25	O-BOX	100
	130	10,0	15/30	25/40	21,0	T-50	●	56633	25	O-BOX	100

* Klemdikte t_{fix, standard} en t_{fix, reduced} afhankelijk van de opgegeven draagkracht uit de ETA-15/0784

Uitvoering: MMS-plus P, rondkop (PanHead)

Aandrijving: T-Drive

Materiaal: roestvaststaal A4 1.4401

Oppervlakte: blank, punt gefosfateerd

Kleurcode op het HECO-etiket

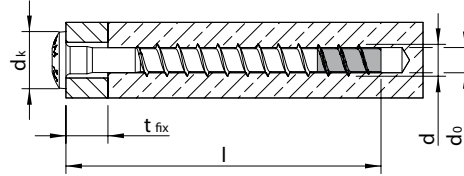

Afmeting d x l [mm]	Boor-Ø d ₀ [mm]	Klemdikte t _{fix, standard} * [mm]	Klemdikte t _{fix, reduced} * [mm]	Kopdiameter d ₀ [mm]	Aandrijving	ETA	Artikelnummer	Aantal per verpakking [st.]	Type verpakking	Aantal per omverpakking [st.]	
7,5 ★	40	6,0	1	5	13,6	T-30	●	53133	50	O-BOX	500
	45	6,0	5	10	13,6	T-30	●	52808	50	O-BOX	500
	55	6,0	1/15	5/20	13,6	T-30	●	52809	50	O-BOX	500
	65	6,0	10/25	1/15/30	13,6	T-30	●	52810	50	O-BOX	500
	75	6,0	20/35	10/25/40	13,6	T-30	●	52782	50	O-BOX	500
	85	6,0	10/30/45	20/35/50	13,6	T-30	●	52783	50	O-BOX	500
	95	6,0	20/40/55	30/45/60	13,6	T-30	●	52784	50	O-BOX	500
	115	6,0	40/60/75	50/65/80	13,6	T-30	●	56635	50	O-BOX	500

* Klemdikte t_{fix, standard} en t_{fix, reduced} afhankelijk van de opgegeven draagkracht uit de ETA-15/0784

Uitvoering: MMS-plus MS, Montagerailschroef met platte rondkop

Aandrijving: T-Drive

Materiaal: roestvaststaal A4 1.4578

Oppervlakte: blank, punt gefosfateerd

Kleurcode op het HECO-etiket

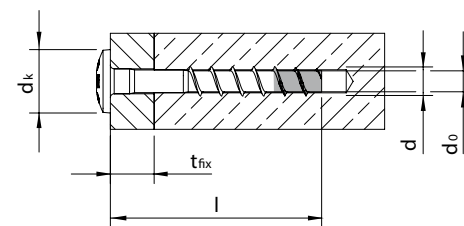

Afmeting d x l [mm]	Boor-Ø d ₀ [mm]	Klemdikte t _{fix, standard} * [mm]	Klemdikte t _{fix, reduced} * [mm]	Kopdiameter d ₀ [mm]	Aandrijving	ETA	Artikelnummer	Aantal per verpakking [st.]	Type verpakking	Aantal per omverpakking [st.]	
7,5 ★	40	6,0	1	5	16,1	T-30	●	64681 NIEUW	50	O-BOX	500
	45	6,0	5	10	16,1	T-30	●	64683 NIEUW	50	O-BOX	500
	55	6,0	1/15	5/20	16,1	T-30	●	63668 NIEUW	50	O-BOX	500

* Klemdikte t_{fix, standard} en t_{fix, reduced} afhankelijk van de opgegeven draagkracht uit de ETA-15/0784



MULTI-MONTI[®]-plus Seismische kits

Productinformatie

- Ideaal voor het bevestigen van aanbouwdelen aan beton onder seismische belasting C1 en C2
- Eenvoudige verwerking van de hoogvaste injectiemortel HEP 1000, zelfs bij verhoogde temperaturen
- Geen lastvermindering dankzij passende vulschijf (inbegrepen in de set)
- Kan gebruikt worden met MULTI-MONTI-plus schroefankers Ø10mm en 12mm
- Kan machinaal worden gemonteerd, geen gedefinieerd aandraaimoment vereist
- Goedgekeurd en bewaakt product



Het goedgekeurde bevestigingssysteem voor verankering in beton onder seismische belasting C1 en C2



Beschrijving: MULTI-MONTI-plus Seismische kits en accessoiresInjectiemortel
HEP 1000 585 mlHigh performance
mengtuit

Vultuit



Vulschijf

Mortelpistool voor
Injectiemortel HEP 1000

Uitvoering	Inhoud	Artikelnummer	ETA	Aantal [st.]	Type verpakking
MULTI-MONTI-plus Seismische kit Ø 10 mm	1 x Injectiemortel HEP 1000 585 ml 3 x High performance mengtuit 50 x Vulschijf Ø 10 mm 24 x Vultuit	63436	•	1	Karton
MULTI-MONTI-plus Seismische kit Ø 12 mm	1 x Injectiemortel HEP 1000 585 ml 3 x High Performance mengtuit 50 x Vulschijf Ø 12 mm 24 x Vultuit	63437	•	1	Karton
MULTI-MONTI-plus Vulschijvenset Ø 10 mm	25 x Vulschijf Ø 10 mm 12 x Vultuit	63963	-	1	SKV
MULTI-MONTI-plus Vulschijvenset Ø 12 mm	25 x Vulschijf Ø 12 mm 12 x Vultuit	63964	-	1	SKV
MULTI-MONTI-plus Mengtuit set	10 x High performance mengtuit	63966	-	1	VARIANTA
HECO-Mortelpistool	1 x HECO-Mortelpistool voor injectiemortel HEP 1000	63965	-	1	Karton

Compatibele MMS-plus-schroefankers vindt u op pagina 174, 175 en 183.

Zetgereedschap voor MULTI-MONTI-TimberConnect

Productinformatie

- Het voor MMS-TC voorgeschreven zetgereedschap
- Speciaal voor HECO vervaardigde zetgereedschap
- Goedgekeurd Z-21.1-1879
- Inschroefdieptemarkering met schaalverdeling voor MMS-TC
- Afgestemd systeem van schroef en bit:
 - betere pasnauwkeurigheid
 - optimale krachtoverbrenging
 - minder doldraaien
- Lange levensduur



Voor de juiste montage van MULTI-MONTI-TimberConnect



De juiste montage

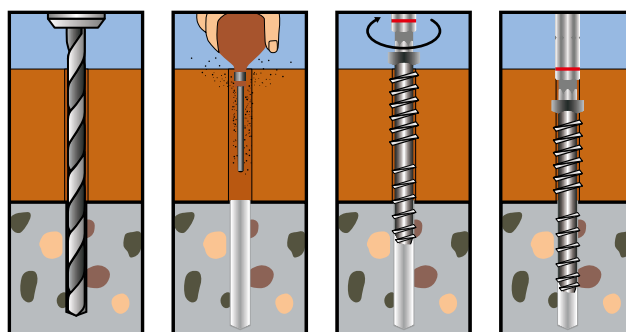

▶ Video

Beschrijving: Zetgereedschap voor MULTI-MONTI-TimberConnect

Uitvoering	Uitgang	Aandrijving	Art.Nr.	Aantal [st.]	Type verpakking
Voor MMS-TC Ø 7,5mm	T-30	9,5 mm (3/8")	43603	1	Bliester
Voor MMS-TC Ø 10mm	T-45	12,5 mm (1/2")*	47095	1	Bliester
Voor MMS-TC Ø 12mm	T-50	12,5 mm (1/2")*	43605	1	Bliester

Bijbehorend schroefanker MMS-TC vindt u op pagina 187

* Met 1/2"-steeksleutelaandrijving



Meethulzen voor MULTI-MONTI-plus

Productinformatie

- Metalen meethuls ter controle van de schroefdraaddiameter voor meervoudig gebruik van MMS-plus 10 tot MMS-plus 20 bij tijdelijke bevestigingen
- Materiaal: roestvaststaal

Slijtagecontrole door middel van een meethuls voor meervoudig gebruik van MMS-plus schroefankers



199

Beschrijving: Meethulzen voor meervoudig gebruik van de MULTI-MONTI-plus

Uitvoering	Hulsbinnendiameter [mm]	Hulslengte [mm]	Artikelnummer	Aantal [st.]	Type verpakking
HECO-meethuls voor MMS-plus 10	9,5	24	47792	1	Plastic zak
HECO-meethuls voor MMS-plus 12	11,5	32	47793	1	Plastic zak
HECO-meethuls voor MMS-plus 16	15,5	36	47794	1	Plastic zak
HECO-meethuls voor MMS-plus 20	19,5	58	47795	1	Plastic zak

Bijbehorend schroefanker MMS-plus vindt u op pagina's 174 tot 183 en 189



Terrasbouw

SCHROEVEN

HECO-TOPIX-plus Vlonderschroef, deeldraad	202
HECO-TOPIX-plus Vlonderschroef, onderkopdraad	204

ACCESSOIRES

HECO-Vlondergeleidersets	206
HECO-Clipperset	208
HECO-Vlonderpads	209
HECO-Stelvoetjes	210
HECO-Afstandhouders	211
HECO-Spanner	212
HECO-Vlonderboor	213

HECO-TOPIX®-plus Standard vlonderschroef

Productinformatie

- Gereduceerde splijtwerking bij het inschroeven door boorpunt
- Speciale coating voor een gering inschroefdraaimoment
- Gebruik ook in hardhout mogelijk (voorboren aanbevolen)
- Klemt niet bij schroefschacht
- Roestvrij staal A2 en A4 voor montagewerkzaamheden buiten
- Goedgekeurd en bewaakt product (CE-markering)



De standaard vlonderschroef met deeldraad

Kleine platverzonken kop met freesribben

Voor eenvoudig en zuiver kopverzinken

Schachtribben

Maken gemakkelijk inschroeven zonder mechanische spanning mogelijk

HECO-TOPIX-plus-punt

Maakt voorboren overbodig en vermindert het risico van splijten van het hout



GripFit®

HECO-Drive maakt werken met één hand mogelijk



GripFit

PerfectPitch®

Optimale schroefdraadspoed voor elke schroeflengte



PerfectPitch



Uitvoering: Vlonderschroef, platverzonken kop met freesribben

Aandrijving: HECO-Drive*

Draadtype: deeldraad

Materiaal: roestvaststaal A2 1.4567

Oppervlakte: blank, glijcoating

Kleurcode op het HECO-etiket

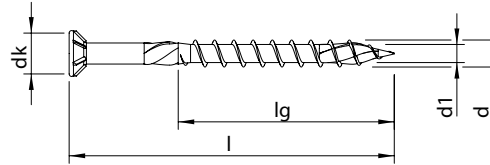

Afmeting d x l [mm]	Draadlengte lg [mm]	Kopdiameter dk [mm]	Aandrijving	ETA	Artikelnummer	Aantal per verpakking [st.]	Type verpakking	Aantal per omverpakking [st.]	
5,0	40	24	8,5	HD-20	•	61739	200	VARIANTA	2.000
	45	27	8,5	HD-20	•	61749	200	VARIANTA	2.000
	50	30	8,5	HD-20	•	61753	200	VARIANTA	2.000
	50	30	8,5	HD-20	•	61755	500	Kunststof doos**	2.000
	60	36	8,5	HD-20	•	61766	200	VARIANTA	2.000
	60	36	8,5	HD-20	•	61768	350	Kunststof doos**	1.400
	70	42	8,5	HD-20	•	61777	200	VARIANTA	2.000
	70	42	8,5	HD-20	•	61779	350	Kunststof doos**	1.400
	80	42	8,5	HD-20	•	61787	200	VARIANTA	2.000
	80	42	8,5	HD-20	•	61789	350	Kunststof doos**	1.400

Uitvoering: Vlonderschroef, platverzonken kop met freesribben

Aandrijving: HECO-Drive*

Draadtype: deeldraad

Materiaal: roestvaststaal A4 1.4578

Oppervlakte: blank, glijcoating

Kleurcode op het HECO-etiket

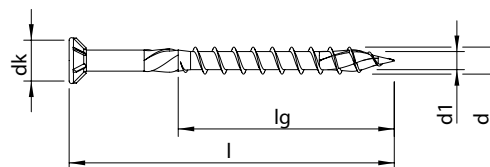

Afmeting d x l [mm]	Draadlengte lg [mm]	Kopdiameter dk [mm]	Aandrijving	ETA	Artikelnummer	Aantal per verpakking [st.]	Type verpakking	Aantal per omverpakking [st.]	
5,0	50	30	8,5	HD-20	•	61916	200	VARIANTA	2.000
	60	36	8,5	HD-20	•	61919	200	VARIANTA	2.000
	70	42	8,5	HD-20	•	61922	200	VARIANTA	2.000
	80	42	8,5	HD-20	•	61925	200	VARIANTA	2.000

* Alle schroeven met HECO-Drive zijn 100% compatibel met conventionele TX-bits.
Het GripFit-effect is alleen gegarandeerd bij gebruik met bijpassende HECO-Drive-bits.

** Kunststof doos: minimale bestelhoeveelheid 1 omverpakking. De bijbehorende boren t.b.v. vlonderplank vindt u op pagina 213

HECO-TOPIX®-plus Professionele vlonderschroef

Productinformatie

- Onderkopdraad voor de fixatie van de vlonderdelen ter voorkoming van knarsende geluiden
- Gereduceerde splijtwerking bij het inschroeven door boorpunt
- Gebruik ook in hardhout mogelijk (voorboren aanbevolen)
- Speciale coating voor een gering inschroefdraaimoment en gemakkelijk uitschroeven
- Roestvrij staal A2 en A4 voor montagewerkzaamheden buiten



De professionele vlonderschroef met onderkopdraad

Kleine verzonken lenskop

Voor eenvoudig kopverzinken met een optimaal design

Onderkopdraad

Voor de fixatie van de vlonderdelen

HECO-TOPIX-plus-punt

Maakt voorboren overbodig en vermindert het risico van splijten van het hout



GripFit®

HECO-Drive maakt werken met één hand mogelijk



GripFit

PerfectPitch®

Optimale schroefdraadspeed voor elke schroeflengte



PerfectPitch



Uitvoering: Vlonderschroef, verzonken lenskop

Aandrijving: HECO-Drive*

Draadtype: onderkopdraad

Materiaal: roestvaststaal A2 1.4567

Oppervlakte: blank, glijcoating



Kleurcode op het HECO-etiket

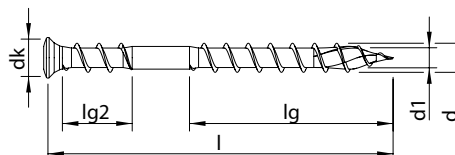

Afmeting d x l [mm]	Gewindelänge lg/lg2 [mm]	Kopdiameter dk [mm]	Aandrijving	ETA	Artikelnummer	Aantal per verpakking [st.]	Type verpakking	Aantal per omverpakking [st.]
5,0	40	16/9	7,0	HD-20	61741	200	VARIANTA	2.000
	50	25/10	7,0	HD-20	61756	200	VARIANTA	2.000
	50	25/10	7,0	HD-20	61758	500	Kunststof doos**	2.000
	60	35/12	7,0	HD-20	61769	200	VARIANTA	2.000
	60	35/12	7,0	HD-20	61771	350	Kunststof doos**	1.400
	70	40/12	7,0	HD-20	61780	200	VARIANTA	2.000
	70	40/12	7,0	HD-20	61782	350	Kunststof doos**	1.400
	80	40/12	7,0	HD-20	61790	200	VARIANTA	2.000

Uitvoering: Vlonderschroef, verzonken lenskop

Aandrijving: HECO-Drive*

Draadtype: onderkopdraad

Materiaal: roestvaststaal A4 1.4578

Oppervlakte: blank, glijcoating



Kleurcode op het HECO-etiket

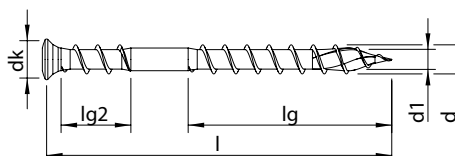

Afmeting d x l [mm]	Gewindelänge lg/lg2 [mm]	Kopdiameter dk [mm]	Aandrijving	ETA	Artikelnummer	Aantal per verpakking [st.]	Type verpakking	Aantal per omverpakking [st.]
5,0	50	25/10	7,0	HD-20	61917	200	VARIANTA	2.000
	60	35/12	7,0	HD-20	61920	200	VARIANTA	2.000
	70	40/12	7,0	HD-20	61923	200	VARIANTA	2.000

* Alle schroeven met HECO-Drive zijn 100% compatibel met conventionele TX-bits. Het GripFit-effect is alleen gegarandeerd bij gebruik met bijpassende HECO-Drive-bits.

** Kunststof doos: minimale bestelhoeveelheid 1 omverpakking. De bijbehorende boren t.b.v. vlonderplank vindt u op pagina 213

HECO-Vlondergeleidersets

Productinformatie

Vlondergeleiders voor gegroefde vlonderplankene

- Afstand van de vlonderplank automatisch ingesteld
- Constructieve bescherming van het hout – geen hout op hout, zorgt voor ventilatie tussen de dekklagen
- Eenvoudige montage met de HECO-TOPIX-vlondergeleiderschroef
- Per verbinding maar 1 schroef (minder bevestigingspunten)

Vlondergeleiderschroef

- HECO-TOPIX-vlondergeleiderschroef met cilinderkop
- 4,5 x 50mm, roestvaststaal A2
- HD-bit met GripFit-effect (inbegrepen in de grote set) voor het eenhandig indraaien van de schroef
- De op het systeem aangepaste cilinderkop past precies tussen de vlonderplanken

Weerbestendige kunststof box

- Keuze uit twee verpakkingen met 30 stuks en met 80 stuks
- Inclusief gebruiksaanwijzing

Het complete pakket voor snelle en nette montage van vlonders



Beschrijving: HECO-Vlondergeleider assortiment

Uitvoering	Artikelnummer	Aantal [st.]	Type verpakking
Kleine vlondergeleiderset middengeleider	48715	1	Kunststof box
Grote vlondergeleiderset middengeleider	48716	1	Kunststof box
Kleine vlondergeleiderset randgeleider	48717	1	Kunststof box

HECO-Vlondergeleidersets – inhoudsoverzicht

Kleine vlondergeleiderset middengeleider



Vlondergeleider middengeleider	30 st.
HECO-TOPIX-Vlondergeleiderschroef	30 st.

Grote vlondergeleiderset middengeleider



Vlondergeleider middengeleider	80 st.
HECO-TOPIX-Vlondergeleiderschroef	80 st.
Bit HECO-Drive (aandrijfgrootte: HD-20)	1 st.

Kleine vlondergeleiderset randgeleider



Vlondergeleider randgeleider	30 st.
HECO-TOPIX-Vlondergeleiderschroef	30 st.

Met een kleine vlondergeleiderset kan ca. 2 m² en met een grote vlondergeleiderset kan ca. 7 m² vlonderoppervlak gemonteerd worden

Kleine vlondergeleiderset – verkoop per omdoos van 4 VE

Grote vlondergeleiderset – verkoop per omdoos van 2 VE

Bestelhoeveelheid per omdoos

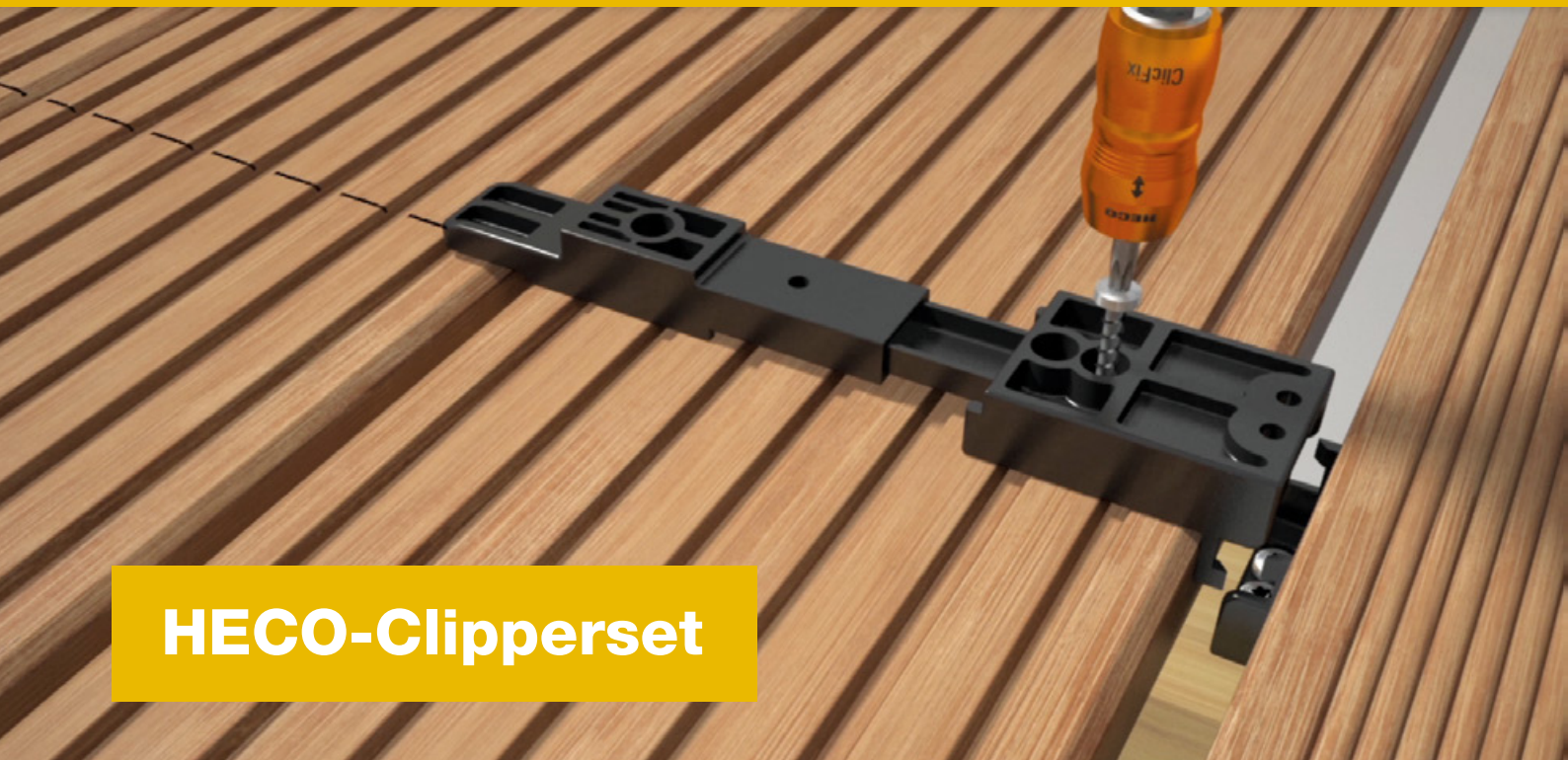

HECO-Clipperset

Productinformatie

HECO-clipper

- Onzichtbare bevestiging incl. HECO-TOPIX-plus schroeven van rvs, geen schroeven in de bovenkant van de bedekking
- Constructieve houtbescherming – geen hout op hout, zorgt voor achterventilatie van de dekplaten
- Afstandhouders tussen de planken (5 mm), snelle montage en een gelijkmatig voegenbeeld
- Plankbreedten variabel tussen 120–150 mm
- De arreteerpin zorgt voor een eenvoudige montage
- De planken kunnen in alle richtingen opzetten en krimpen
- De planken kunnen snel en zonder beschadigingen worden gedemonteerd – ideaal voor huurhuizen (bij een verhuizing)
- Van glasvezelversterkte polyamide (min. 98 % gerecycled materiaal)

HECO-TOPIX-plus clipperschroeven

- HECO-TOPIX-plus-clipperschroeven met ronde kop en T-Drive voor een exacte schroefverbinding
- 4,0 x 25 en 4,0 x 30 mm, roestvaststaal A2

De onzichtbare bevestiging voor vlonderbekledingen van hout en WPC zonder groef



▶ Video

Beschrijving: HECO-Clipper met HECO-TOPIX-plus-Clipperschroeven

Uitvoering	Artikelnummer	Aantal [st.]	Type verpakking
HECO-Clipperset	62052	1	Karton
Inhoud			
HECO-Clipper 120 – 150 mm		50 st.	
HECO-TOPIX-plus-Clipperschroeven 4,0 x 25 mm (vlonderdikte 20 – 24 mm)		150 st.	
HECO-TOPIX-plus-Clipperschroeven 4,0 x 30 mm (vlonderdikte 20 – 24 mm)		100 st.	



HECO-Vlonderpads

Productinformatie

- Vochtregulerend
- Geluid isolerend
- Geen waterberging
- Onverrotbaar
- Anti-slip
- De pads zijn in drie diktes verkrijgbaar: 3, 8 en 20 mm (de 3 mm dikke pad is uitsluitend als vereffeningspad bedoeld)
- De aanbevolen minimale dikte van de pads onder de houten constructie bedraagt 8 mm

De veilige onderbouw voor elke vlonder

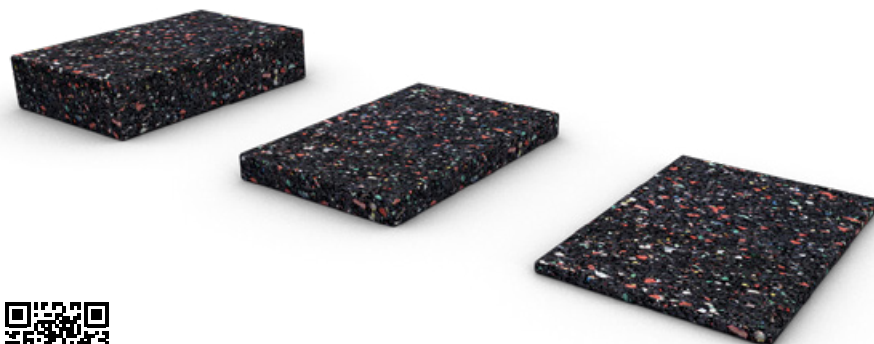

▶ Video

Beschrijving: HECO-Vlonderpads (vereffeningspads)

Uitvoering	Artikelnummer	Aantal [st.]	Type verpakking
HECO-Vlonderpads 3 x 60 x 90, 60 st.	49770	1	Karton
HECO-Vlonderpads 8 x 60 x 90, 24 st.	49771	1	Karton
HECO-Vlonderpads 20 x 60 x 90, 12 st.	49772	1	Karton



HECO-Stelvoetjes

Productinformatie

- De stelvoet is binnen zijn marges traploos instelbaar
- Door de voetjes gewoon naar rechts of links te draaien, kan de vereiste hoogte ook in ingebouwde staat eenvoudig worden ingesteld
- De beweeglijke kop compenseert hellingen van de ondergrond tot max. 8%
- Zeer goede achterventilatie van de vlonderconstructie
- Stelvoet vervaardigt uit hard kunststof polypropyleen



Video

Perfect voor oneffen terrein



Beschrijving: HECO-Stelvoetjes, hoogte verstelbaar, zelfnivellerend

Uitvoering	Artikelnummer	Aantal [st.]	Type verpakking
HECO-Stelvoetjes, hoogte: 35–70 mm, 42 st.	58010	1	Karton
HECO-Stelvoetjes, hoogte: 65–155 mm, 32 st.	58011	1	Karton

HECO-Afstandhouder

Productinformatie

- De kleurcodering van de afstandhouders voorkomt een verwisseling bij het aanleggen van de vlonder
- Door de vorm van de afstandhouders wordt voorkomen dat deze tussen de planken in de voegenspleet kunnen vallen
- Dankzij de greep kan de afstandhouder ook als hij stevig zit vastgeklemd makkelijk worden verwijderd
- De randen van de afstandhouder zijn op belangrijke plaatsen behandeld/afgeschuind; deuken in het hout worden op deze manier voorkomen

Gelijkmatig voegenbeeld ook bij vloerplanken die niet recht zijn



211

Beschrijving: HECO-Afstandhouder

Uitvoering	Artikelnummer	Aantal [st.]	Type verpakking
------------	---------------	--------------	-----------------

HECO-Afstandhouder	49774	1	Kunststof box
--------------------	-------	---	---------------

Inhoud

3 mm – blauwe afstandhouder	8 st.
5 mm – rode afstandhouder	8 st.
7 mm – gele afstandhouder	8 st.

Verkoop per omdoos van 4 VE – Bestelhoeveelheid per omdoos



HECO-Spanner voor vlonderplanken

Productinformatie

- Vlonderplanken spanner met drie afstandhouders, daardoor kunnen meerdere breedtes gelijktijdig gespannen worden
- Er zijn haast traploze spanbreedten mogelijk
- Zelfs een grote spankracht kan met een geringe spierkracht worden gerealiseerd
- De montage van de gespannen vlonderplanken kan plaatsvinden zonder zekering of permanent vasthouden van de spanner

Krachtig, robuust en flexibel



Beschrijving: HECO-spanner voor vlonderplanken

Uitvoering	Artikelnummer	Aantal [st.]	Type verpakking
HECO-Spanner voor vlonderplanken	49767	1	Karton



© alexandre zveiger - Fotolia.com

HECO-Vlonderboor

Productinformatie

- Hoogwaardige schroefboren voor vlonderdelen
- Combinatie van boor en soevereinfrees
- Snel en schoon werken zonder splinters
- Vlonderdelen splijten niet
- Vervangende boor als toebehør verkrijgbaar

Vlonderdelen snel en netjes monteren



213

Beschrijving: HECO-schroefboren voor vlonderdelen en trapboren

Uitvoering	Artikelnummer	Aantal [st.]	Type verpakking
HECO-vlonderboor Ø3,5mm	64590 NIEUW	1	Bliester
HECO-vervangende boor Ø3,5mm	64591 NIEUW	1	Bliester
HECO-vlonderboor Ø4,0mm	47375	1	Bliester
HECO-vervangende boor Ø4,0mm	47875	1	Bliester

De bijbehorende vlonderschroeven vindt u op pagina's 203 en 204



Schroeven assortimenten

ASSORTIMENTSKOFFERS

HECO-TOPIX-plus Assortimentskoffer 3005, met 3.005 schroeven, HECO-L-BOXX 102	217
HECO-Assortimentskoffer L-BOXX 102, leeg	217
HECO-TOPIX-plus Assortimentskoffer 1760, met 1.760 schroeven, HECO-Systainer ³ M137	218
HECO-Assortimentskoffer Systainer ³ M137, leeg	218
HECO-TOPIX-plus Assortimentskoffer 700, met 700 schroeven, HECO-L-BOXX Mini	219
HECO-Assortimentskoffer L-BOXX Mini, leeg	219
HECO-TOPIX-plus Assortimentskoffer 700, met 700 schroeven, HECO-L-BOXX Mini met transparante deksel	219
HECO-Assortimentskoffer L-BOXX Mini met transparante deksel, leeg	219
HECO-Assortimentskoffer L-BOXX 238, leeg	220
HECO-Assortimentskoffer Systainer ³ M237, leeg	220

215

PROFISETS

HECO-TOPIX-plus Profiset "Timmerman", met 1.650 schroeven	221
HECO-TOPIX-plus Profiset "Schrijnwerker", met 3.700 schroeven	221

ACCESSOIRES

HECO-ProClick Tool Bag M, Gereedschapstas	222
---	-----



HECO-TOPIX®-plus Assortimentskoffers

Productinformatie

- Maximale flexibiliteit bij houtverbindingen dankzij een divers assortiment voldraad en deeldraadschroeven
- Robuuste en duurzame opbergoplossing
- Overzichtelijke organisatie en snelle toegang tot de benodigde schroeven
- Verkrijgbaar in L-BOXX en Systainer³ systeem
- Stapelbaar binnen het betreffende systeem (L-BOXX en Systainer³)
- Alle assortimentskoffers zijn ook leeg verkrijgbaar
- HECO-TOPIX-plus houtschroeven zorgen voor veilige en duurzame verbindingen en bieden unieke voordelen voor gebruikers met de functies MagicClose en GripFit
- Slechts één bitmaat voor alle schroeven in de box
- Alle assortimenten zijn inclusief bijpassende HECO-Drive-bits

Altijd de juiste schroef bij de hand



Systainer³



L-BOXX

Bevat schroeftypes

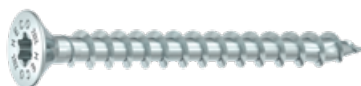

Platverzonden kop, voldraad, HECO-Drive, HD-20, verzinkt blauw, A3K



Platverzonden kop, deeldraad, HECO-Drive, HD-20, verzinkt blauw, A3K



Beschrijving: HECO-TOPIX-plus Assortimentskoffer 3005, HECO-L-BOXX 102



Art.Nr: 60194 400 3,5 x 16 HD-20	Art.Nr: 60213 200 3,5 x 20 HD-20	Art.Nr: 60239 200 3,5 x 25 HD-20	Art.Nr: 60255 200 3,5 x 30 HD-20	Art.Nr: 60278 200 3,5 x 35 HD-20	Art.Nr: 60302 200 3,5 x 40 HD-20
Art.Nr: 60389 200 4,0 x 20 HD-20	Art.Nr: 60406 200 4,0 x 25 HD-20	Art.Nr: 60428 200 4,0 x 30 HD-20	Art.Nr: 60452 200 4,0 x 35 HD-20	Art.Nr: 58561 1 HECO- Bit-Selector	
Art.Nr: 60776 75 4,5 x 70 HD-20	Art.Nr: 60475 200 4,0 x 40 HD-20	Art.Nr: 60525 100 4,0 x 50 HD-20	Art.Nr: 60556 100 4,0 x 60 HD-20	Art.Nr: 60957 40 5,0 x 80 HD-20	
Art.Nr: 60731 100 4,5 x 50 HD-20	Art.Nr: 60759 50 4,5 x 60 HD-20	Art.Nr: 60905 50 5,0 x 50 HD-20	Art.Nr: 60929 50 5,0 x 60 HD-20	Art.Nr: 60945 40 5,0 x 70 HD-20	

incl. HECO-Bit-Belector met 10 HD-bits en HECO-ClicFix snelwisselhouder



Uitvoering	Assortiment voldraad	Assortiment deeldraad	Artikelnummer	Aantal [st.]	Type verpakking
HECO-TOPIX-plus Assortimentskoffer 3005, HECO-L-BOXX 102 met 3.005 schroeven in 20 maten, incl. HECO-Bit-Selector, met inzetbakjes set K3 en dekselinzet	3,5 x 16mm, 400 st. 3,5 x 20mm, 200 st. 3,5 x 25mm, 200 st. 3,5 x 30mm, 200 st. 3,5 x 35mm, 200 st. 3,5 x 40mm, 200 st. 4,0 x 20mm, 200 st. 4,0 x 25mm, 200 st. 4,0 x 30mm, 200 st. 4,0 x 35mm, 200 st. 4,0 x 40mm, 200 st. 4,0 x 50mm, 100 st. 4,0 x 60mm, 100 st.	4,5 x 50mm, 100 st. 4,5 x 60mm, 50 st. 4,5 x 70mm, 75 st. 5,0 x 50mm, 50 st. 5,0 x 60mm, 50 st. 5,0 x 70mm, 40 st. 5,0 x 80mm, 40 st.	62897	1	L-BOXX
HECO-Assortimentskoffer L-BOXX 102, leeg, met inzetbakjes set K3 en dekselinzet	—	—	62899	1	L-BOXX

Beschrijving: HECO-TOPIX-plus Assortimentskoffer 1760, HECO-Systainer³ M137



Art.Nr. 60194 300 3,5x16 HD-20	Art.Nr. 60452 200 4,0x35 HD-20	Art.Nr. 60731 100 4,5x50 HD-20	Art.Nr. 60929 100 5,0x60 HD-20
Art.Nr. 60255 200 3,5x30 HD-20	Art.Nr. 60475 200 4,0x40 HD-20	Art.Nr. 60759 100 4,5x60 HD-20	Art.Nr. 60945 100 5,0x70 HD-20
Art.Nr. 60428 200 4,0x30 HD-20	Art.Nr. 60525 100 4,0x50 HD-20	Art.Nr. 60905 100 5,0x50 HD-20	Art.Nr. 60957 60 5,0x80 HD-20

incl. bijpassende korte en lange bit HD-20







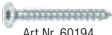

218

Uitvoering	Assortiment voldraad	Assortiment deeldraad	Artikelnummer	Aantal [st.]	Type verpakking
HECO-TOPIX-plus Assortimentskoffer 1760, HECO-Systainer ³ M137, met 1.760 schroeven in 12 maten, incl. bijpassende korte en lange bit HD-20, met dieptrekinzet en EPP dekselinzet	3,5 x 16, 300 st. 3,5 x 30, 200 st. 4,0 x 30, 200 st. 4,0 x 35, 200 st. 4,0 x 40, 200 st. 4,0 x 50, 100 st.	4,5 x 50, 100 st. 4,5 x 60, 100 st. 5,0 x 50, 100 st. 5,0 x 60, 100 st. 5,0 x 70, 100 st. 5,0 x 80, 60 st.	63465	1	Systainer ³
HECO-Assortimentskoffer Systainer ³ M137, leeg, met dieptrekinzet en EPP dekselinzet	—	—	63466	1	Systainer ³

Beschrijving: HECO-TOPIX-plus Assortimentskoffer 700, HECO-L-BOXX Mini

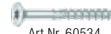

 Art.Nr. 60194 200 3,5 x 16 HD-20	 Art.Nr. 60255 200 3,5 x 30 HD-20	 Art.Nr. 60452 100 4,0 x 35 HD-20
 Art.Nr. 60475 100 4,0 x 40 HD-20	 Art.Nr. 60534 50 4,0 x 50 HD-20	 Art.Nr. 60759 50 4,5 x 60 HD-20

incl. HD-20 bits (2 stuks)



Uitvoering	Assortiment voldraad	Assortiment deeldraad	Artikelnummer	Aantal [st.]	Type verpakking
HECO-TOPIX-plus Assortimentskoffer 700, HECO-L-BOXX Mini met 700 schroeven in 6 maten, incl. 2 HD-20 bits	3,5 x 16mm, 200 st. 3,5 x 30mm, 200 st. 4,0 x 35mm, 100 st. 4,0 x 40mm, 100 st.	4,0 x 50mm, 50 st. 4,5 x 60mm, 50 st.	62902	1	L-BOXX
HECO-Assortimentskoffer L-BOXX Mini, leeg, incl. instelbare verdelers	—	—	62901	1	L-BOXX
HECO-TOPIX-plus Assortimentskoffer 700, HECO-L-BOXX Mini met transparante deksel, met 700 schroeven in 6 maten, incl. 2 HD-20 bits	3,5 x 16mm, 200 st. 3,5 x 30mm, 200 st. 4,0 x 35mm, 100 st. 4,0 x 40mm, 100 st.	4,0 x 50mm, 50 st. 4,5 x 60mm, 50 st.	63887	1	L-BOXX
HECO-Assortimentskoffer L-BOXX Mini met transparante deksel, leeg, incl. instelbare verdelers	—	—	63888	1	L-BOXX

Beschrijving: HECO-Assortimentskoffer L-BOXX 238, leeg



Uitvoering	Assortiment voldraad	Assortiment deeldraad	Artikelnummer	Aantal [st.]	Type verpakking
HECO-Assortimentskoffer L-BOXX 238, leeg, zonder inzetbakjes en dekselinzet	—	—	62900	1	L-BOXX

220

Beschrijving: HECO-Assortimentskoffer Systainer³ M237, leeg



Uitvoering	Assortiment voldraad	Assortiment deeldraad	Artikelnummer	Aantal [st.]	Type verpakking
HECO-Assortimentskoffer Systainer ³ M237, leeg, zonder dieptrekinzet en EPP dekselinzet	—	—	63142	1	Systainer ³

Beschrijving: HECO-TOPIX-plus Profisets "Timmerman" en "Schrijnwerker"





Inhoud Profiset "Timmerman"



HECO-TOPIX-plus, platverzonken kop, voldraad, blauw verzinkt

	Afmeting	Aandrijving	Aantal	Artikel
	4,0 x 40	HD-20	500	60476
	4,0 x 60	HD-20	200	60556
	4,5 x 50	HD-25	200	62293
	4,5 x 70	HD-25	200	62295
	5,0 x 80	HD-25	200	62304
	5,0 x 100	HD-25	100	62305
	6,0 x 120	HD-30	100	61128

HECO-TOPIX-plus, platverzonken kop, deeldraad, blauw verzinkt

	Afmeting	Aandrijving	Aantal	Artikel
	6,0 x 160	HD-30	100	61163

HECO-TOPIX-plus, tellerkop, deeldraad, blauw verzinkt



	Afmeting	Aandrijving	Aantal	Artikel
	8,0 x 200	T-40	50	61319

HECO-Bit-Selector, incl. 10 bits en HECO-ClickFix bithouder

	Afmeting	Aandrijving	Aantal	Artikel
	-	HD	1	58561

Inhoud Profiset "Interieurbouwer"

HECO-TOPIX-plus, platverzonken kop, voldraad, blauw verzinkt

	Afmeting	Aandrijving	Aantal	Artikel
	3,5 x 35	HD-20	1.000	60279
	3,5 x 40	HD-20	500	60303
	4,0 x 35	HD-20	500	60453
	4,0 x 40	HD-20	500	60476
	4,0 x 50	HD-20	500	60526
	4,0 x 60	HD-20	200	60556
	4,5 x 50	HD-20	200	60725
	5,0 x 70	HD-20	200	60940
	5,0 x 100	HD-20	100	60972

HECO-Bit-Selector, incl. 10 bits en HECO-ClickFix bithouder

	Afmeting	Aandrijving	Aantal	Artikel
	-	HD	1	58561



Uitvoering	Artikelnummer	Aantal [st.]	Type verpakking
HECO-TOPIX-plus Profiset "Timmerman", met 1.650 schroeven, incl. HECO-Bit-Selector	63504	1	Karton
HECO-TOPIX-plus Profiset "Interieurbouwer", met 3.700 schroeven, incl. HECO-Bit-Selector	63503	1	Karton

Beschrijving: HECO-ProClick Tool Bag M, gereedschapstas, leeg



Volledig compatibel met het ProClick- en L-BOXX-systeem

222

Uitvoering	Artikelnummer	Aantal [st.]	Type verpakking
HECO-ProClick-Tool-Bag-M, gereedschapstas, leeg	63086	1	Karton



Bits en bithouders

BITS

Schroefbits, HECO- en Pozi-Drive	227
HECO-Bit-Selector	227
Toonbankdisplays met HECO-Drive bits	228
Bliestertrays met HECO-Drive bits	228

BITHOUDERS EN ADAPTERS

HECO-ClicFix snelwisselhouder	229
HECO-MagicFlip magnetische bithouder	229
HECO-Stubby Mini-schroevendraaier	229
Boorhouder adapter MK3	229
HECO-PowerLock Houtbouwschroevenhouder	230



Bits en bithouders

Productinformatie

Algemeen

- Speciaal voor HECO vervaardigde merkbits
- Lange levensduur



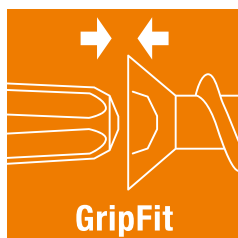

HECO-Drive

- Zelf ontwikkeld en gepatenteerd systeem van schroef en bit
- Maakt eenhandig werken mogelijk, ook met roestvrijstalen schroeven dankzij GripFit-effect
- Optimale krachtoverbrenging
- Verminderd corrosiegevaar in schroefkop dankzij lage bitslijtage
- Praktische kleurcodering van de aandrijfgrootten
- Volledige compatibiliteit met T-Drive gegarandeerd (schroeven en bits)

Voor HECO-schroeven met HECO-/T-Drive en Pozi-Drive



Beschrijving: Schroefbits voor HECO-schroeven met HECO- en Pozi-Drive

Uitvoering	Aandrijving	Artikelnummer	Aantal [st.]	Type verpakking	
HECO-Drive Bits, 25 mm, C 6,3 (1/4")					
	HD-10	57093	10	Blister	
		59154	2	Blister	
	HD-15	57094	10	Blister	
		59155	2	Blister	
	HD-20	57095	10	Blister	
		59156	2	Blister	
	HD-25	57096	10	Blister	
		59889	2	Blister	
	HD-30	57097	10	Blister	
		59157	2	Blister	
	HD-40	57098	10	Blister	
		59158	2	Blister	
	HECO-Drive Bits, 70 mm, E 6,3 (1/4")				
		HD-20	57101	3	Blister
HD-25		59722	3	Blister	
HD-30		57102	3	Blister	
HD-40		57103	3	Blister	
HECO-Drive Bits, 120 mm, E 6,3 (1/4")					
	HD-40	64587 NIEUW	1	Blister	
Pozi-Drive Bits, 25 mm, C 6,3 (1/4")					
	PZD-1	57104	10	Blister	
	PZD-2	57105	10	Blister	
	PZD-3	57106	10	Blister	

Alle HECO-Drive-bits zijn 100% compatibel met conventionele TX-schroeven.

Het GripFit-effect is alleen gegarandeerd bij gebruik met bijpassende HECO-Drive-schroeven.

Beschrijving: HECO-Bit-Selector met HECO bits, 25 mm, C 6,3 (1/4") en HECO-ClicFix snelwisselhouder, E 6,3 (1/4")

Uitvoering	Aandrijving	Artikelnummer	Aantal [st.]	Type verpakking
HECO-Bit-Selector				
	zie hieronder	A 57107 B 58561	1	Blister
	Inhoud A			
	1 x PZD-1	1 x HD-10	1 x HD-25	1 x ClicFix snelwisselhouder
	1 x PZD-2	1 x HD-15	1 x HD-30	
	1 x PZD-3	2 x HD-20	1 x HD-40	
	Inhoud B			
1 x HD-10	3 x HD-20	2 x HD-30	1 x ClicFix snelwisselhouder	
1 x HD-15	1 x HD-25	2 x HD-40		

Alle HECO-Drive-bits zijn 100% compatibel met conventionele TX-schroeven.

Het GripFit-effect is alleen gegarandeerd bij gebruik met bijpassende HECO-Drive-schroeven.

Beschrijving: Toonbankdisplays met HECO-Drive bits

Bits, 25mm



Bits, 70mm



Uitvoering	Inhoud / Bitgroottes	Artikelnummer	Aantal [st.]	Type verpakking
Toonbankdisplay met HECO-Drive bits, 25 mm, C 6,3 (1/4")	70x HD-20 (7 Blister met 10 Bits) 70x HD-25 (7 Blister met 10 Bits) 70x HD-30 (7 Blister met 10 Bits) 70x HD-40 (7 Blister met 10 Bits)	63100	1	POS-display
Toonbankdisplay met HECO-Drive bits, 70 mm, E 6,3 (1/4")	21x HD-20 (7 Blister met 3 Bits) 21x HD-25 (7 Blister met 3 Bits) 21x HD-30 (7 Blister met 3 Bits) 21x HD-40 (7 Blister met 3 Bits)	63101	1	POS-display

228

Beschrijving: Blister-Trays met HECO-Drive bits, C 6,3 (1/4")

Bits, HD-20



Bits, HD-25



Bits, HD-30



Bits, HD-40



Uitvoering	Inhoud / Bitgroottes	Artikelnummer	Aantal [st.]	Type verpakking
Blister-Tray met HECO-Drive bits, HD-20, 25 mm	30x HD-20 (15 Blister met 2 Bits)	62498	1	POS-display
Blister-Tray met HECO-Drive bits, HD-25, 25 mm	30x HD-25 (15 Blister met 2 Bits)	63099	1	POS-display
Blister-Tray met HECO-Drive bits, HD-30, 25 mm	30x HD-30 (15 Blister met 2 Bits)	62500	1	POS-display
Blister-Tray met HECO-Drive bits, HD-40, 25 mm	30x HD-40 (15 Blister met 2 Bits)	62501	1	POS-display

Beschrijving: HECO-Bithouders



HECO-ClicFix



HECO-MagicFlip

Uitvoering	Artikelnummer	Bitopname	Aandrijving	Aantal [st.]	Type verpakking
HECO-ClicFix snelwisselhouder, magnetisch, met mechanische vergrendeling	48541	Universeel voor zeskant 6,3 (1/4")	E 6,3 (1/4")	1	Bliester
HECO-MagicFlip bithouder, met sterke ringmagneet, houdt houtbouschroeven betrouwbaar vast op het bit	57715	Universeel voor zeskant 6,3 (1/4")	E 6,3 (1/4")	1	Bliester

Beschrijving: HECO-Stubby Mini-schroevendraaier met 6-delige bitmagazijn in handvat



229

Uitvoering	Artikelnummer	Bitopname	Aantal [st.]	Type verpakking
HECO-Stubby Mini-schroevendraaier, magnetisch, Bits, C 6,3 (1/4"): HD-10, HD-15, HD-20, HD-30, PZD-1, PZD-2	63073	Universeel voor zeskant 6,3 (1/4")	1	SKV

Beschrijving: Boorhouder adapter MK3



Adapter MK 3 – Vierkant, 12,5 (1/2")



Adapter MK3 – Binnenzeskant 11,5 mm

Uitvoering	Artikelnummer	Uitgang	Aandrijving	Aantal [st.]	Type verpakking
MK 3 – Vierkant, 12,5 (1/2")	59306	Vierkant 12,5 (1/2")	MK 3	1	Bliester
MK 3 – Binnenzeskant 11,5 mm (voor HECO-PowerLock)	58662	Binnenzeskant 11,5	MK 3	1	Bliester



HECO-PowerLock Houtbouwschroevenhouder

Productinformatie

- Voorkomt dat het bit wegglijdt van de schroefkop
- Maakt krachtbesparend indraaien mogelijk
- Maakt een snelle en betrouwbare montage mogelijk
- Max. draaimoment 130Nm
- Inclusief T-40 en T-50 bits



▶ Video



Vervangende bits:



T-40, C 8 (5/16") (XL)

T-50, C 8 (5/16") (XL)



T-40, E 6,3 (1/4") (L)

T-50, C 6,3 (1/4") (L)

Beschrijving: HECO-PowerLock Houtbouwschroevenhouder incl. bits

Uitvoering	Artikelnummer	Aantal [st.]	Type verpakking
HECO-PowerLock XL, incl. T-40 en T-50 bit	57263	1	Bliester
Vervangend bit voor HECO-PowerLock XL, T-40	57762	1	Bliester
Vervangend bit voor HECO-PowerLock XL, T-50	57763	1	Bliester
HECO-PowerLock L, incl. T-40 en T-50 bit	63959	1	Bliester
Vervangend bit voor HECO-PowerLock L, T-40	63960	1	Bliester
Vervangend bit voor HECO-PowerLock L, T-50	63961	1	Bliester
Adapter MK 3 – Binnenzeskant 11,5 mm	58662	1	Bliester

Compatibiliteitsoverzicht

Uitvoering	Artikelnummer	Geslacht voor schroeven met kopdiameter, d.
HECO-PowerLock XL	57263	16,5–22,5mm
HECO-PowerLock L	63959	10–16,5mm

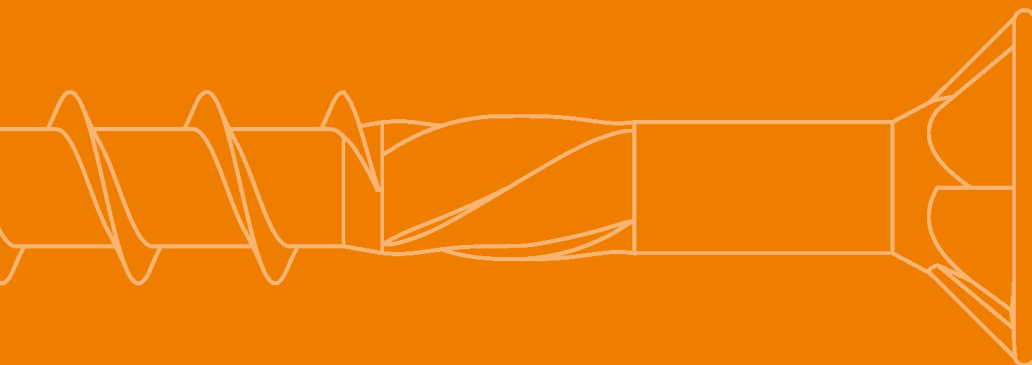

HECO-Schrauben GmbH & Co. KG

Dr.-Kurt-Steim-Straße 28,
78713 Schramberg
+49 (0)7422/989-0
info@heco-schrauben.de

Agent Benelux:

Jac. Lowie & Zoon bv
Vogelkersberg 5A, 3755 BN EEMNES
+31 (0) 35 / 54 159 58
office@lowie.nl

www.heco-schrauben.com

A partner of 



Naar de online
productcatalogus

